

30BQ015

SCHOTTKY RECTIFIER

3 Amp



Major Ratings and Characteristics

Characteristics	30BQ015	Units
$I_{F(AV)}$ Rectangular waveform	3.0	A
V_{RRM}	15	V
I_{FSM} @ $t_p=5\mu s$ sine	650	A
V_F @ 1.0Apk, $T_J=75^\circ C$	0.30	V
T_J range	-55 to 100	$^\circ C$

Description/Features

The 30BQ015 surface-mount Schottky rectifier has been designed for applications requiring low forward drop and small foot prints on PC boards. Typical applications are in disk drives, switching power supplies, converters, free-wheeling diodes, battery charging, and reverse battery protection.

- Small foot print, surface mountable
- Very low forward voltage drop
- High frequency operation
- Guard ring for enhanced ruggedness and long term reliability

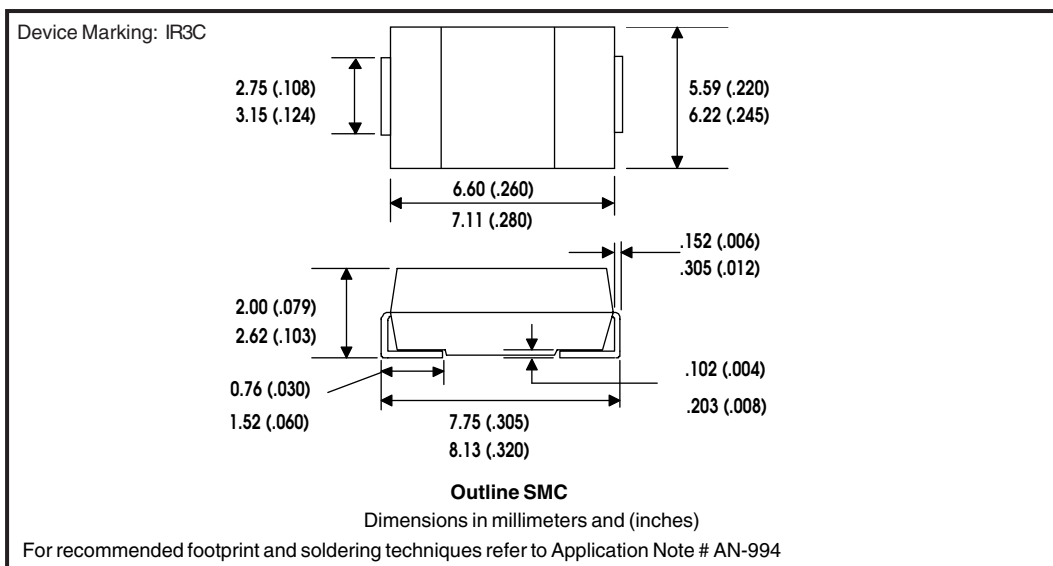

30BQ015

Bulletin PD-2.490 rev. A 05/00

International
IR Rectifier

Voltage Ratings

Part number	30BQ015
V_R Max. DC Reverse Voltage (V)	15
V_{RWM} Max. Working Peak Reverse Voltage (V)	25

Absolute Maximum Ratings

Parameters	30BQ	Units	Conditions
$I_{F(AV)}$ Max. Average Forward Current	3.0	A	50% duty cycle @ $T_C=83^\circ\text{C}$, rectangular waveform
	4.0		50% duty cycle @ $T_C=78^\circ\text{C}$, rectangular waveform
I_{FSM} Max. Peak One Cycle Non-Repetitive Surge Current	650	A	5 μs Sine or 3 μs Rect. pulse
	95		10ms Sine or 6ms Rect. pulse
E_{AS} Non Repetitive Avalanche Energy	9	mJ	$T_J=25^\circ\text{C}$, $I_{AS}=0.6\text{A}$, $L=6.6\text{mH}$
I_{AR} Repetitive Avalanche Current	0.6	A	Current decaying linearly to zero in 1 μsec Frequency limited by T_J max. $V_a = 1.5 \times V_r$ typical

Electrical Specifications

Parameters	30BQ	Units	Conditions
V_{FM} Max. Forward Voltage Drop (1)	0.35	V	@ 3A $T_J = 25^\circ\text{C}$
	0.40	V	@ 6A $T_J = 25^\circ\text{C}$
	0.30	V	@ 3A $T_J = 75^\circ\text{C}$
	0.35	V	@ 6A $T_J = 75^\circ\text{C}$
I_{RM} Max. Reverse Leakage Current (1)	4	mA	$T_J = 25^\circ\text{C}$ $V_R = \text{rated } V_R$
	50	mA	$T_J = 100^\circ\text{C}$ $V_R = \text{rated } V_R$
C_T Max. Junction Capacitance	1120	pF	$V_R = 5V_{DC}$ (test signal range 100KHz to 1Mhz) 25°C
L_S Typical Series Inductance	3.0	nH	Measured lead to lead 5mm from package body
dv/dt Max. Voltage Rate of Change (Rated V_R)	10.00	V/ μs	

Thermal-Mechanical Specifications

Parameters	30BQ	Units	Conditions
T_J Max. Junction Temperature Range	-55 to 100	$^\circ\text{C}$	
T_{stg} Max. Storage Temperature Range	-55 to 100	$^\circ\text{C}$	
R_{thJL} Max. Thermal Resistance, Junction to Lead (2)	12	$^\circ\text{C}/\text{W}$	DC Operation
R_{thJA} Max. Thermal Resistance, Junction to Ambient	46	$^\circ\text{C}/\text{W}$	DC Operation
wt Approximate Weight	0.24	g	
Case Style	SMC		Similar DO-214AB

(1) Pulse Width < 300 μs , Duty Cycle < 2%

(2) Mounted 1 inch square PCB, Thermal Probe connected to lead 2mm from Package

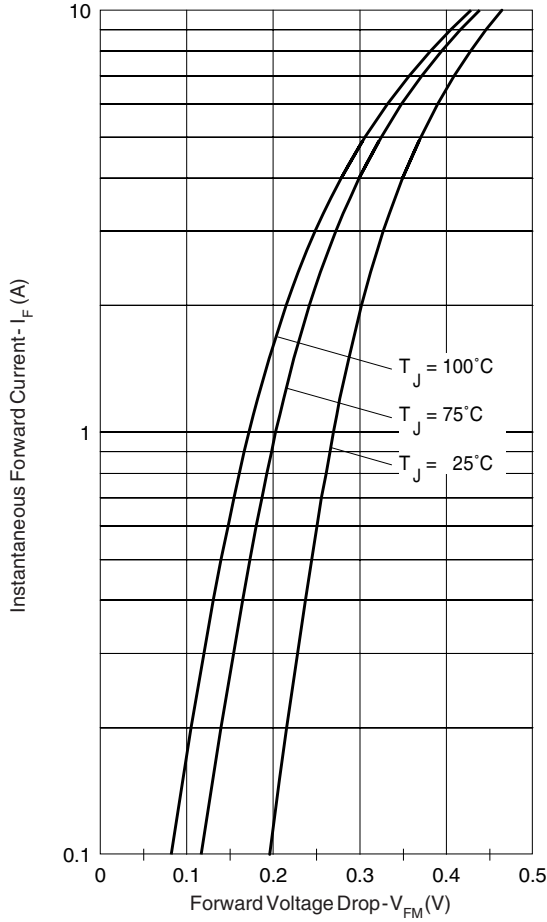

Fig. 1 - Max. Forward Voltage Drop Characteristics (PerLeg)

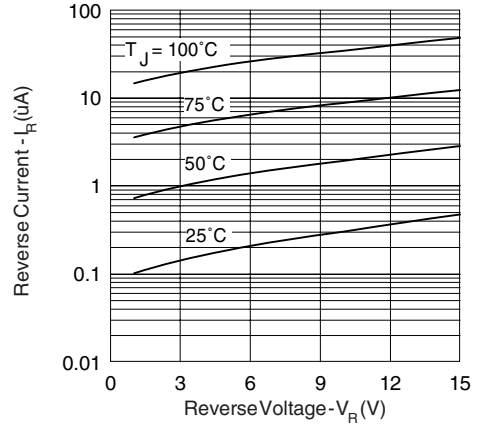

Fig. 2 - Typical Values Of Reverse Current Vs. Reverse Voltage (PerLeg)

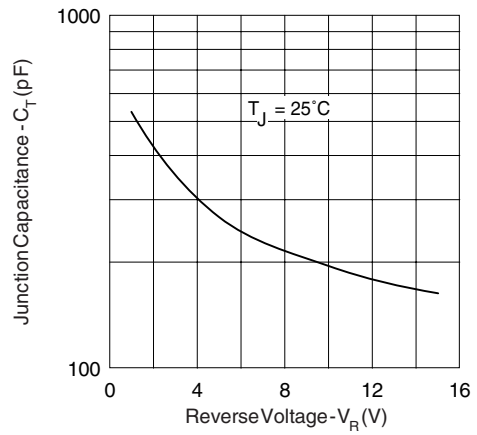

Fig. 3 - Typical Junction Capacitance Vs. Reverse Voltage (PerLeg)

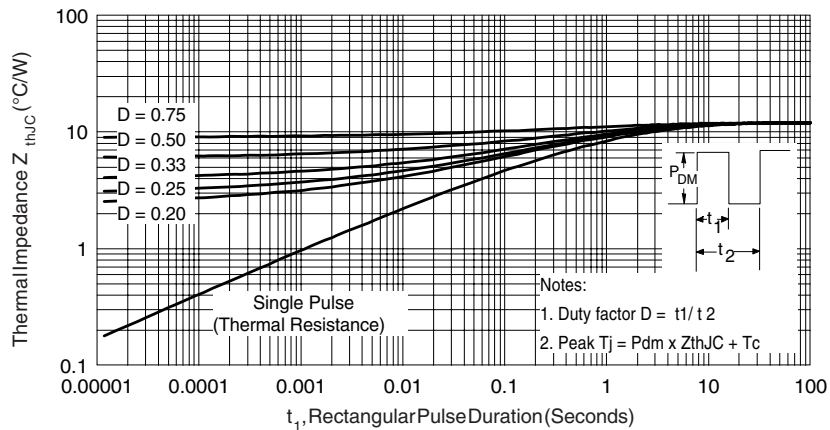

Fig. 4 - Max. Thermal Impedance Z_{thJC} Characteristics (PerLeg)

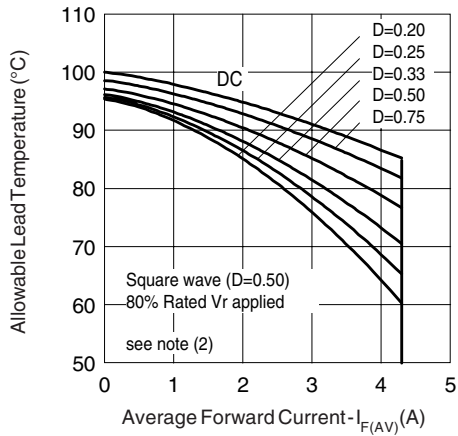

Fig. 4 - Maximum Average Forward Current Vs. Allowable Lead Temperature

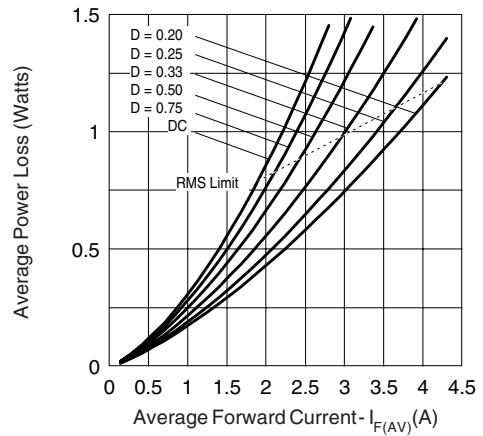

Fig. 5 - Maximum Average Forward Dissipation Vs. Average Forward Current

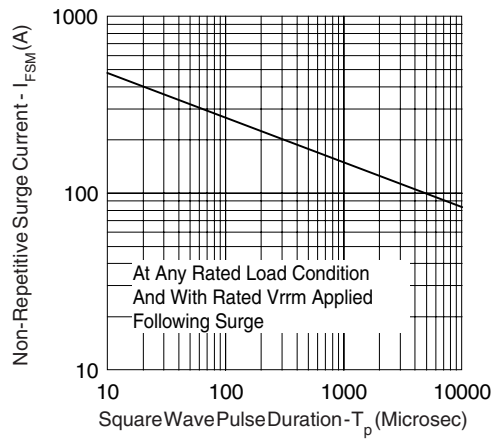

Fig. 6 - Maximum Peak Surge Forward Current Vs. Pulse Duration

(2) Formula used: $T_c = T_j - (Pd + Pd_{REV}) \times R_{thJC}$;

Pd = Forward Power Loss = $I_{F(AV)} \times V_{FM} @ (I_{F(AV)} / D)$ (see Fig. 6);

Pd_{REV} = Inverse Power Loss = $V_{R1} \times I_{R1} (1 - D)$; $I_{R1} @ V_{R1} = 80\%$ rated V_R

Tape & Reel Information

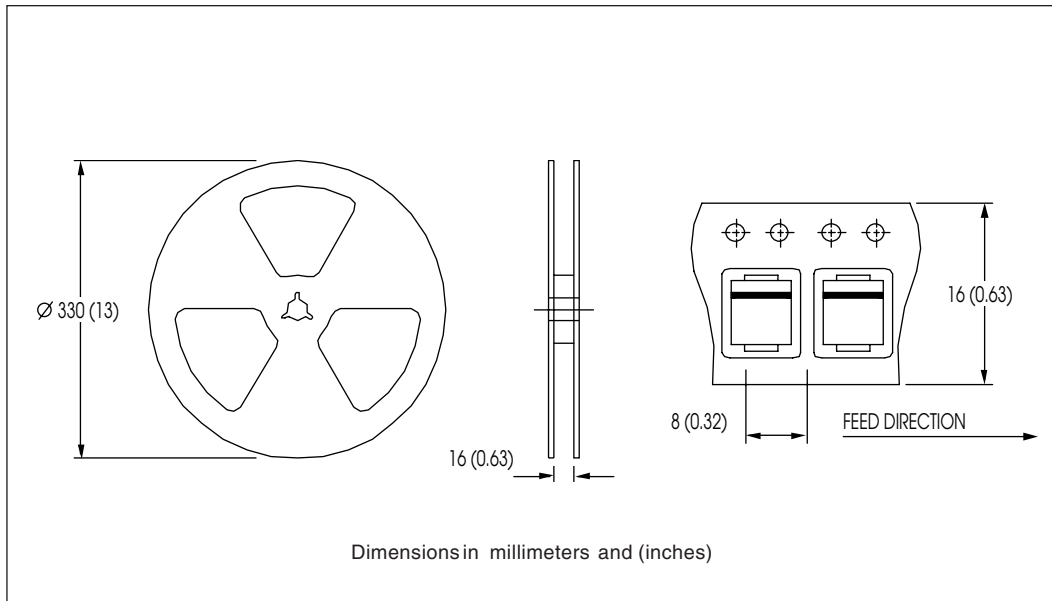

Marking & Identification

Each device has 4 characters, configured two digits on two rows, for identification. The first row designates the device as manufactured by International Rectifier as indicated by the letters "IR". The second row indicates the current rating and voltage/process. See the drawing below for marking code.

FIRST ROW

IR

SECOND ROW

1st DIGIT = CURRENT RATING
 2nd DIGIT = VOLTAGE/PROCESS

EXAMPLE: IR — INTERNATIONAL RECTIFIER
 1F — 40 VOLT/STANDARD PROCESS
 | — 1 AMP

1st DIGIT	2nd DIGIT
CURRENT	VOLTAGE/PROCESS
1 = 1 AMP	C = 15 VOLTS
	E = 30 VOLTS
	F = 40 VOLTS
	H = 60 VOLTS
	J = 100 VOLTS

Ordering Information

30BQ SERIES - TAPE AND REEL

WHEN ORDERING, INDICATE THE PART NUMBER AND THE QUANTITY (IN MULTIPLES OF 3000 PIECES).

EXAMPLE: 30BQ015TR - 6000 PIECES

30BQ SERIES - BULK QUANTITIES

WHEN ORDERING, INDICATE THE PART NUMBER AND THE QUANTITY (IN MULTIPLES OF 1000 PIECES).

EXAMPLE: 30BQ015 - 2000 PIECES

30BQ015

Bulletin PD-2.490 rev. A 05/00

International
IOR Rectifier

International
IOR Rectifier

WORLD HEADQUARTERS: 233 Kansas St., El Segundo, California 90245 U.S.A. Tel: (310) 322 3331. Fax: (310) 322 3332.
EUROPEAN HEADQUARTERS: Hurst Green, Oxted, Surrey RH8 9BB, U.K. Tel: ++ 44 1883 732020. Fax: ++ 44 1883 733408.
IR CANADA: 15 Lincoln Court, Brampton, Markham, Ontario L6T3Z2. Tel: (905) 453 2200. Fax: (905) 475 8801.
IR GERMANY: Saalburgstrasse 157, 61350 Bad Homburg. Tel: ++ 49 6172 96590. Fax: ++ 49 6172 965933.
IR ITALY: Via Liguria 49, 10071 Borgaro, Torino. Tel: ++ 39 11 4510111. Fax: ++ 39 11 4510220.
IR FAR EAST: K&H Bldg., 2F, 30-4 Nishi-Ikebukuro 3-Chome, Toshima-Ku, Tokyo, Japan 171. Tel: 81 3 3983 0086.
IR SOUTHEAST ASIA: 1 Kim Seng Promenade, Great World City West Tower, 13-11, Singapore 237994. Tel: ++ 65 838 4630.
IR TAIWAN: 16 Fl. Suite D.207, Sec. 2, Tun Haw South Road, Taipei, 10673, Taiwan. Tel: 886 2 2377 9936.

<http://www.irf.com>

Fax-On-Demand: +44 1883 733420

Data and specifications subject to change without notice.