

MEGGITT CGS

HIGH VOLTAGE RESISTORS
HIGH VALUE RESISTORS
HIGH POWER RESISTORS
ALUMINIUM CLAD RESISTORS
CURRENT SENSE RESISTORS

High Power Resistor

TYPE SBC (SQUARE CERAMIC) SERIES

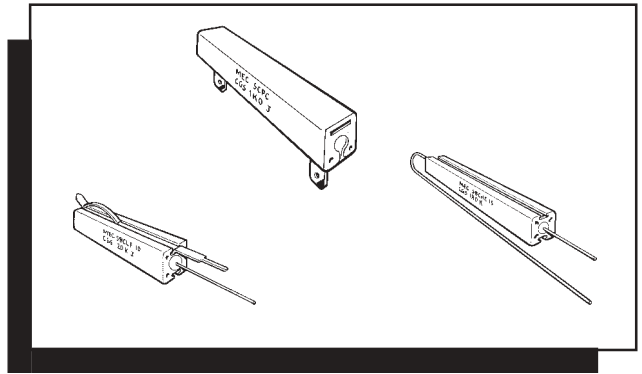

This range of Power Wirewound Resistors are wound on continuous glass fibre elements or have a ceramic core depending on resistor value. The element is housed in a ceramic case and sealed with an inorganic silica filler. Their construction gives a resistor with high insulation resistance and low surface temperature, capable of withstanding high overload currents. These resistors are ideally suited to a variety of applications within industrial and commercial environments, where performance and reliability are of prime importance. Applications include fan force ovens, cooker hoods, power supplies and triac based speed controls. Custom Design Variants in value and style are welcomed.

MEGGITT CGS KEY FEATURES

- UP TO 17 WATTS
- FUSIBLE STYLES
- VERTICAL OR AXIAL
- NON FLAMMABLE
- SPECIAL SOLVENT RESISTANCE
- ATTRACTIVELY PRICED
- CUSTOMER SPECIALS INVITED
- WIDELY AVAILABLE FROM DISTRIBUTION

CONSTRUCTION

A range of flame-proof wirewound resistors with excellent electrical and mechanical characteristics. The resistance wire is wound on a fibreglass or ceramic core and protected by a ceramic body. This construction combines good thermal characteristics with high insulation resistance, and gives good physical protection. Lead length allows vertical or horizontal mounting.

ELECTRICAL

Resistance Values:	Series E24 5% E12 10% (see tables for value limits per style)
Resistance Tolerance:	±5% ± 10%
Maximum Continuous Voltage:	$\sqrt{P \times R}$
Load Life:	±3% 1000 hours at 70°C
Power Rating:	See Surface Temperature Curve (below)

ENVIRONMENTAL & MECHANICAL

Temperature Coefficient of Resistance:	200ppm/°C (400ppm/°C below 18R)
Resistance Change due to Solder Heat:	Less than 0.2% (350°C for 2.5 seconds)
Voltage Coefficient of Resistance:	Negligible
Temperature Range:	0°C to 70°C
Load Stability:	Less than 5% (full load at 70°C for 1000 hours)
Long Term Damp Heat:	Less than 0.2% (21 days at 40°C for 93% humidity)
Shelf Life:	Less than 1.0% (per 12 months)
Insulation Resistance:	Greater than 10 ⁴ M
Dielectric Strength:	2000V RMS
Lead Material:	Steel - Solder coat
Marking:	Legend mark, Manufacturer name, type, ohmic value and tolerance.

SURFACE TEMPERATURE RISE CURVE

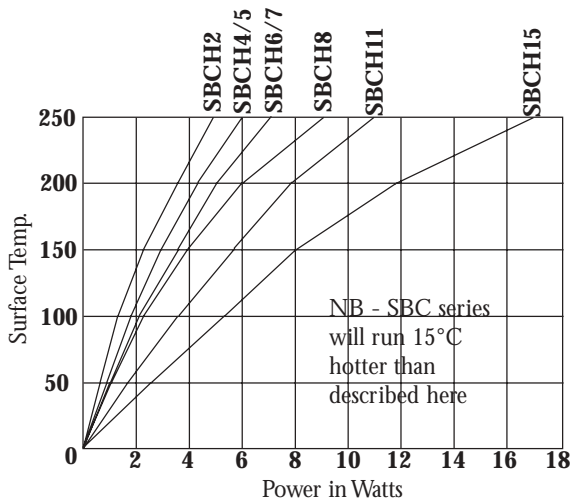

POWER DERATING CURVE

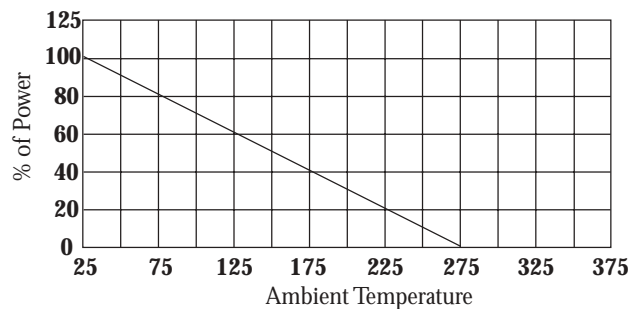

TYPE SBC - SBCH (Axial Power Resistor)

We offer three ceramic profiles for the main wattage sizes. These are for additional heat dissipation and vertical mounting of resistors. The suffix for each style is as follows:-

SBC Standard

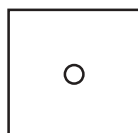

SBCH 4/5/6/7

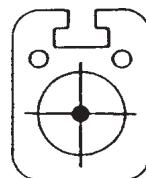

SBCH 8/11/15

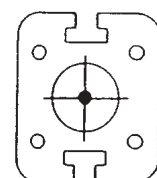

TYPE SBCHE (For Vertical Mounting)

We offer SBCHE Styles with one lengthened lead for vertical mounting. See additional hardware on last page.

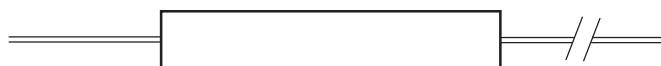

Lead Length 20mm longer than case length. Supplied with one longer lead wrapped back in flute in ceramic.

TYPE SBC - (NO FLUTES IN CERAMIC)

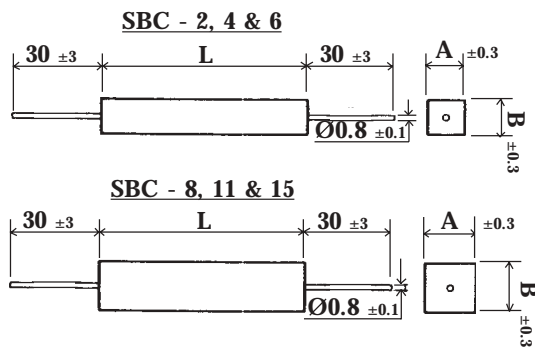

Model	Power	Ohmic Values		Dimensions			Weight grams
	Max.	Min.	Max.	A	B	L	
SBC-2	2 W	0R2	150R	6.4	6.4	20	2.3
SBC-4	4 W	0R3	3K3	6.4	6.4	25	2.9
SBC-6	6 W	1R0	8K2	6.4	6.4	38	4.2
SBC-8	8 W	1R0	8K2	9	9	38	7.4
SBC-11	10 W	3R3	12K	9	9	50	10.8
SBC-15	15 W	4R7	18K	9	9	75	15.3

L = Length of Ceramic Section

TYPE SBCH - (FLUTES IN CERAMIC)

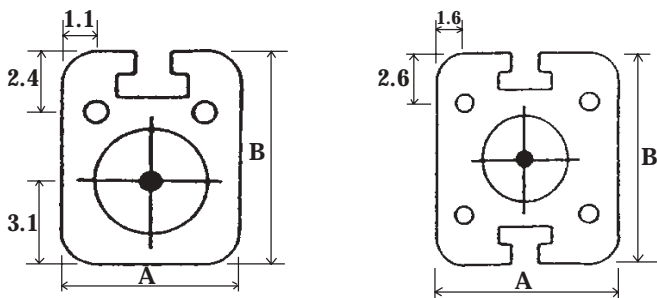

Model	Power	Ohmic Values		Dimensions			Weight grams
	Max.	Min.	Max.	A	B	L	
SBCH-4	4 W	0R2	6K8	7	8	20	2.2
SBCH-5	5 W	0R3	10K	7	8	25	3.5
SBCH-6	7 W	0R47	22K	7	8	38	5.0
SBCH-7	7 W	0R33	15K	9	10	25	6.0
SBCH-8	9 W	1R0	8K2	9	10	38	8.0
SBCH-11	11 W	1R0	22K	9	10	50	10.0
SBCH-15	17 W	1R0	22K	9	10	75	15.0

L = Length of Ceramic Section

TYPE SCPC (RADIAL PLUG-IN STYLE)

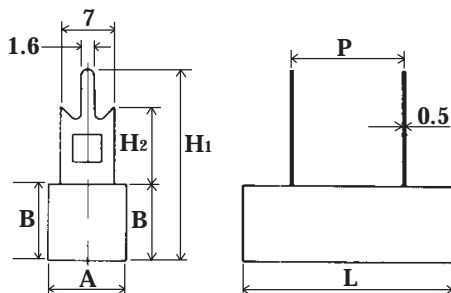

Model	Power	Ohmic Values		Dimensions ± 1mm					
	Max.	Min.	Max.	L	A	B	P	H ₁	H ₂
SCPC-3	3W	0R1	330R	22	10	9	10	23	10
SCPC-5	5W	0R1	1K0	27	10	9	15	25	10
SCPC-7	7W	0R1	2K7	35	10	9	22.5	25	10
SCPC-10	10W	0R2	8K2	50	10	9	37	25	10
SCPC-20	20W	0R3	15K	63	13	12	49	43	25

L = Length of Ceramic Section

TYPE SBCLF (EXTERNALLY FUSED STYLE)

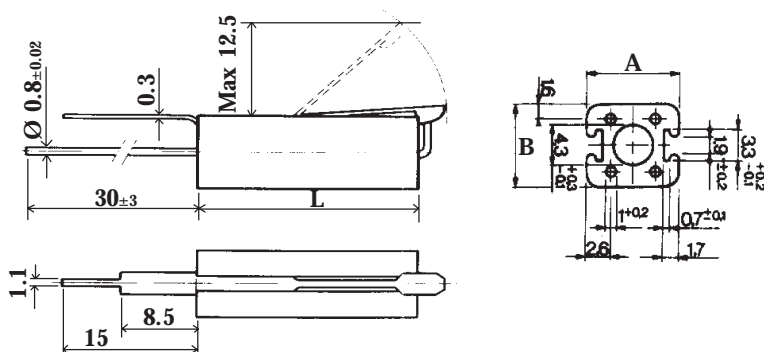

Model	Power	Ohmic Values		Dimensions		
	Max.	Min.	Max.	A	B	L
SBCLF-4	4 W	2R2	2K2	10	9	25
SBCLF-5	5.5 W	2R2	5K6	10	9	38
SBCLF-7	7 W	3R3	8K2	10	9	50
SBCLF-10	10 W	4R7	12K	10	9	75

Solder for fuse is SnPb 60:40

L = Length of Ceramic

TYPE SBCV (VERTICAL MOUNT STYLE)

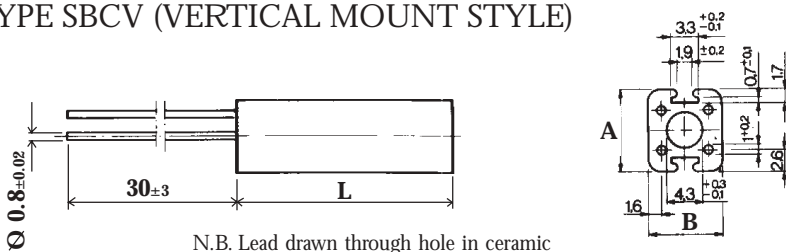

N.B. Lead drawn through hole in ceramic

Model	Power	Ohmic Values		Dimensions		
	Max.	Min.	Max.	A	B	L
SBCV-6	7W	2.2	2K2	10	9	25
SBCV-8	9 W	2.2	5K6	10	9	38
SBCV-11	11 W	3.3	8K2	10	9	50
SBCV-15	17W	4.7	12K	10	9	75

L = Length of Ceramic Section

TYPE SPW (HIGH POWER FASTON STYLE)

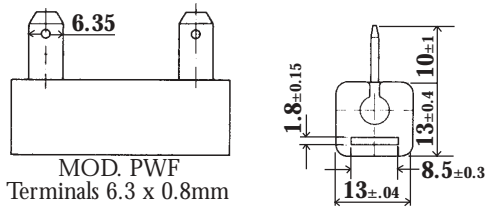

MOD. PWF
Terminals 6.3 x 0.8mm

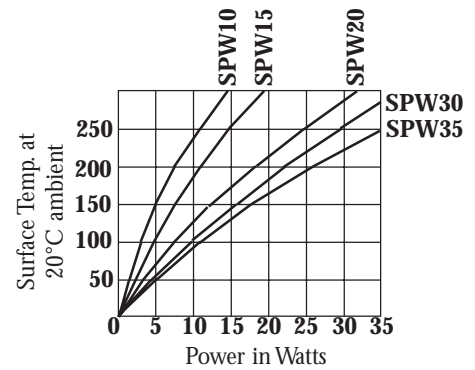

Model	Power Max	Ohmic Values		Dimensions			Weight grams
		Min.	Max.	A	B	L	
SPW-10	10W	2R2	8K2	10	13	38	14
SPW-15	15W	3R3	10K	10	13	50	20
SPW-20	20W	4R7	15K	10	13	75	32
SPW-30	30W	6R8	18K	10	13	100	46
SPW-35	35W	8R2	22K	10	13	120	59

L = Length of Ceramic Section

ACCESSORIES

This device is used with models SBCV. ORDER LC1 SUPPORT

ORDER LC1

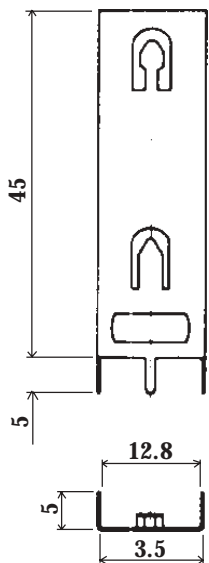

These can be used with SBCH/SBCV models
ORDER BCV SUPPORT PILLAR

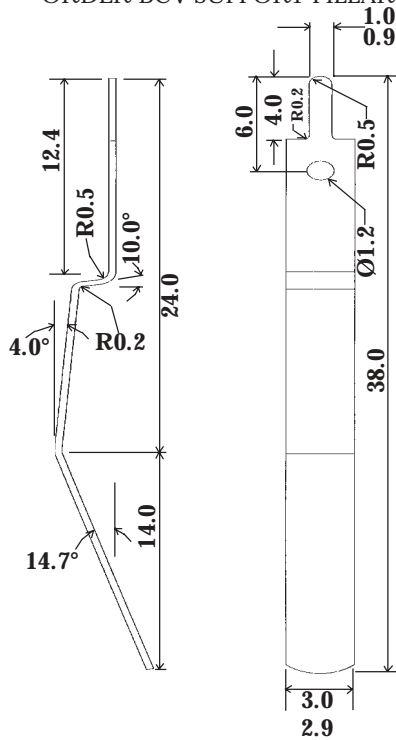

This device is suitable for SPW Series.
order PW7 AS ACCESSORY AT THE SAME TIME AS RESISTORS

ORDER PW7

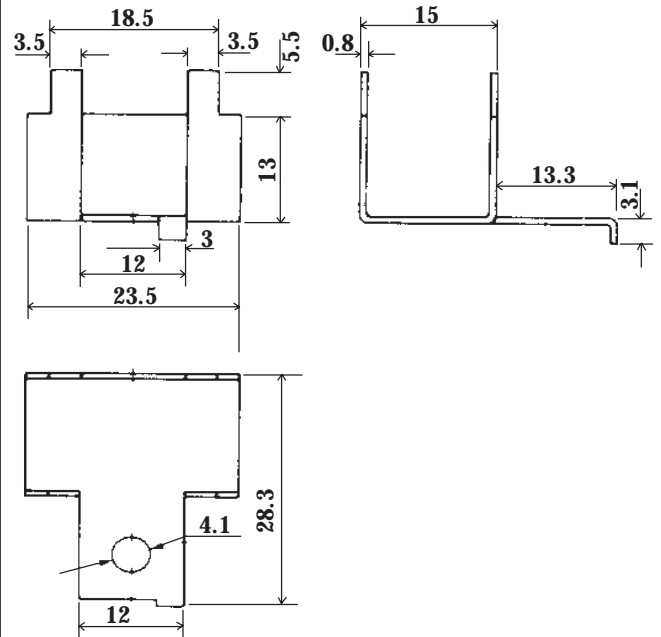

HOW TO ORDER

SBCH	6	1K0	J
COMMON PART	POWER RATING (WATTS)	RESISTANCE VALUE	TOLERANCE
SBCH - Axial SBCV - Vertical SBCLF - Vertical fusible SBCHE - Axial one long lead SCPC - Radial with standoffs SPW - Lug type	See Relevent Table	0.1 Ohm (100 mille Ohms) R10 1 Ohm (1000 mille Ohms) 1R0 1 K Ohm (1000 Ohms) 1K0	J - 5% K - 10%

N.B. All resistors are supplied with arklone proof seal

Meggitt Electronic Components Ltd. Ohmic House, Westmead Industrial Estate, Swindon, Wilts. SN5 7US
Telephone:(01793)487301(Admin.) (01793)611666 (Sales) Email: sales@megelec.co.uk Fax:(01793) 611777

This publication is issued to provide outline information only and (unless specifically agreed to the contrary by the Company in writing) is not to form part of any order or be regarded as a representation relating to the products or service concerned. We reserve the right to alter without notice the specification, design, price or conditions of supply of any product or service. Whilst Meggitt Electronic Components products are of the very highest quality and reliability, all electronic components can occasionally be subject to failure. Where failure of a Meggitt Electronic Components product could result in life threatening consequences, then the circuit and application must be discussed with the Company. Such areas might include ECG, respiratory, and other medical and nuclear applications and any non fail safe applications circuit.