

4 PIN SOP PHOTOTRANSISTOR AC INPUT PHOTOCOUPLER

EL3H4-G Series

Features:

- AC input response
- Current transfer ratio
(CTR: Min. 20% at $I_F = \pm 1\text{mA}$, $V_{CE} = 5\text{V}$)
- High isolation voltage between input and output ($V_{iso} = 3750\text{ V rms}$)
- Compact small outline package
- Pb free and RoHS compliant.
- UL approved (No. E214129)
- VDE approved (No. 132249)
- SEMKO approved
- NEMKO approved
- DEMKO approved
- FIMKO approved
- CSA approved (No. 2021495)

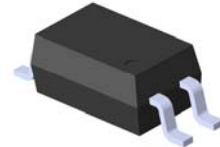

Schematic

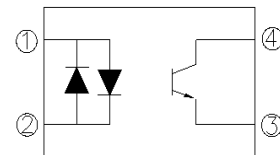

Pin Configuration

1. Anode / Cathode
2. Cathode / Anode
3. Emitter
4. Collector

Description

The EL3H4-G series contains two infrared emitting diode, connected in inverse parallel, optically coupled to a phototransistor encapsulated with green compound. It is packaged in a 4-pin small outline SMD package.

Applications

- AC line monitor
- Programmable controllers
- Telephone line interface
- Unknown polarity DC sensor



LIGHTING FOREVER

4 PIN SOP PHOTOTRANSISTOR AC INPUT PHOTOCOUPLER

EL3H4-G Series

Absolute Maximum Ratings ($T_a=25^{\circ}\text{C}$)

Parameter		Symbol	Rating	Unit
Input	Forward current	I_F	± 50	mA
	Peak forward current ($t = 10\mu\text{s}$)	I_{FM}	1	A
	Power dissipation No derating required up to $T_a = 100^{\circ}\text{C}$	P_D	70	mW
Output	Power dissipation Derating factor (above $T_a = 80^{\circ}\text{C}$)	P_C	150	mW
			3.7	mW/ $^{\circ}\text{C}$
	Collector-Emitter voltage	V_{CEO}	80	V
	Emitter-Collector voltage	V_{ECO}	6	V
Total power dissipation		P_{tot}	200	mW
Isolation voltage ^{*1}		V_{iso}	3750	V rms
Operating temperature		T_{opr}	-55~+100	$^{\circ}\text{C}$
Storage temperature		T_{stg}	-55~+125	$^{\circ}\text{C}$
Soldering temperature ^{*2}		T_{sol}	260	$^{\circ}\text{C}$

Notes

*1 AC for 1 minute, R.H.= 40 ~ 60% R.H. In this test, pins 1 & 2 are shorted together, and pins 3 & 4 are shorted together.

*2 For 10 seconds.

4 PIN SOP PHOTOTRANSISTOR AC INPUT PHOTOCOUPLER

EL3H4-G Series

Electrical Characteristics ($T_a=25^\circ\text{C}$ unless specified otherwise)

Input

Parameter	Symbol	Min.	Typ.*	Max.	Unit	Condition
Forward voltage	V_F	-	1.2	1.4	V	$I_F = \pm 20\text{mA}$
Reverse current	I_R	-	-	10	μA	$V_R = 4\text{V}$
Input capacitance	C_{in}	-	50	250	pF	$V = 0, f = 1\text{KHz}$

Output

Parameter	Symbol	Min.	Typ.*	Max.	Unit	Condition
Collector-Emitter dark current	I_{CEO}	-	-	100	nA	$V_{CE} = 20\text{V}, I_F = 0\text{mA}$
Collector-Emitter breakdown voltage	BV_{CEO}	80	-	-	V	$I_C = 0.1\text{mA}$
Emitter-Collector breakdown voltage	BV_{ECO}	6	-	-	V	$I_E = 0.01\text{mA}$

Transfer Characteristics ($T_a=25^\circ\text{C}$ unless specified otherwise)

Parameter	Symbol	Min.	Typ.*	Max.	Unit	Condition
Current Transfer ratio	EL3H4	20	-	300	%	$I_F = \pm 1\text{mA}, V_{CE} = 5\text{V}$
	EL3H4A	50	-	150		
Collector-emitter saturation voltage	$V_{CE(sat)}$	-	0.1	0.2	V	$I_F = \pm 20\text{mA}, I_C = 1\text{mA}$
Isolation resistance	R_{IO}	5×10^{10}	10^{11}	-	Ω	$V_{IO} = 500\text{Vdc}, 40\sim 60\% \text{R.H}$
Floating capacitance	C_{IO}	-	0.6	1.0	pF	$V_{IO} = 0, f = 1\text{MHz}$
Rise time	T_r	-	6	18	μs	$V_{CE} = 2\text{V}, I_C = 2\text{mA}, R_L = 100\Omega$
Fall time	T_f	-	8	18	μs	

* Typical values at $T_a = 25^\circ\text{C}$

4 PIN SOP PHOTOTRANSISTOR AC INPUT PHOTOCOUPLER

EL3H4-G Series

Typical Performance Curves

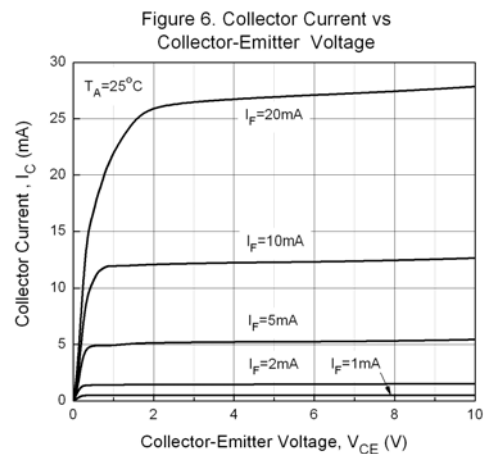
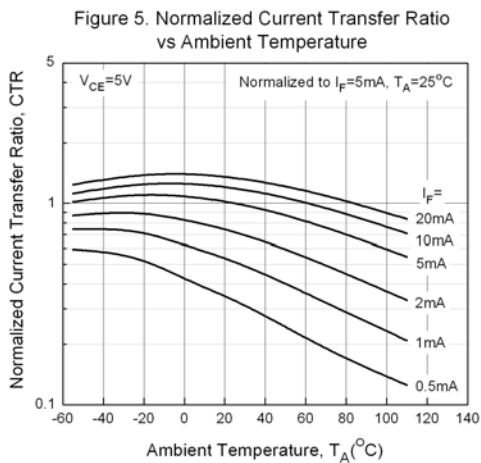
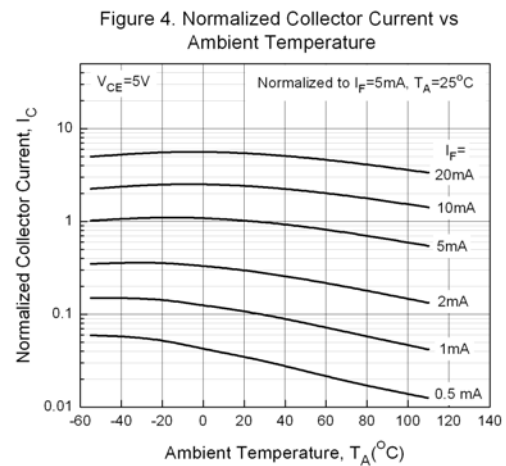
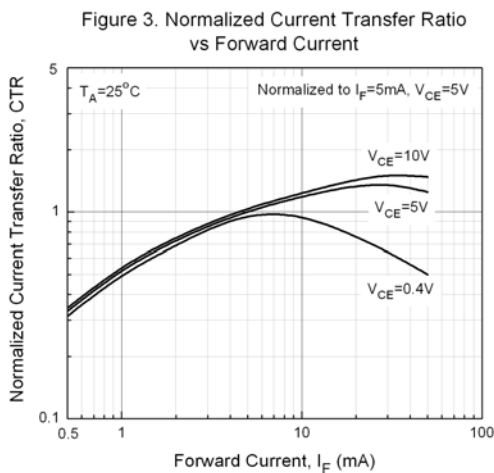
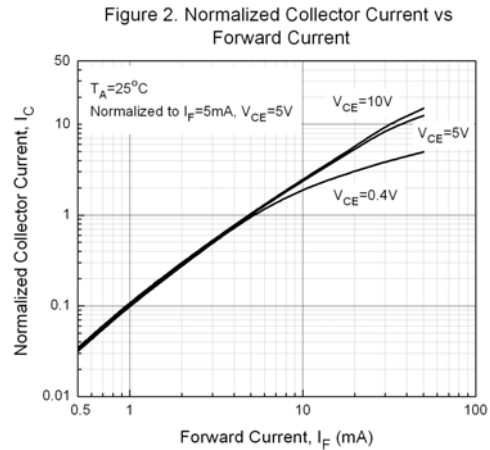
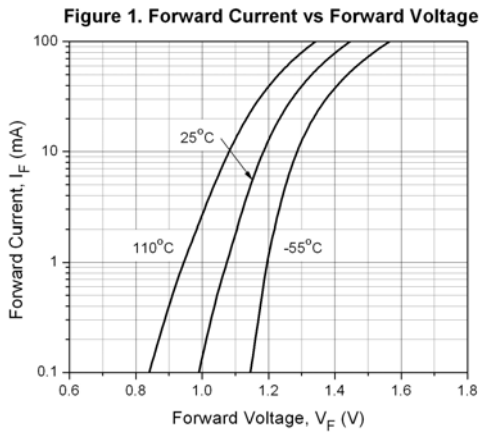

4 PIN SOP PHOTOTRANSISTOR AC INPUT PHOTOCOUPLER

EL3H4-G Series

Figure 7. Collector Current vs Collector-Emitter Voltage

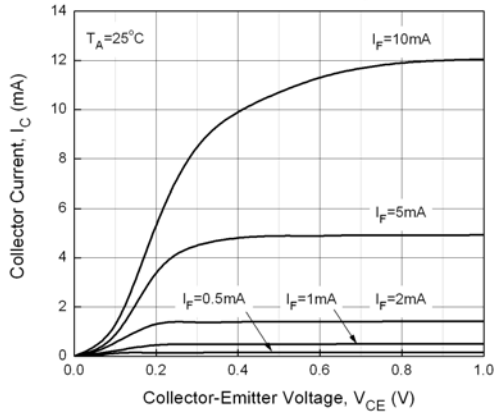

Figure 8. Collector Dark Current vs Ambient Temperature

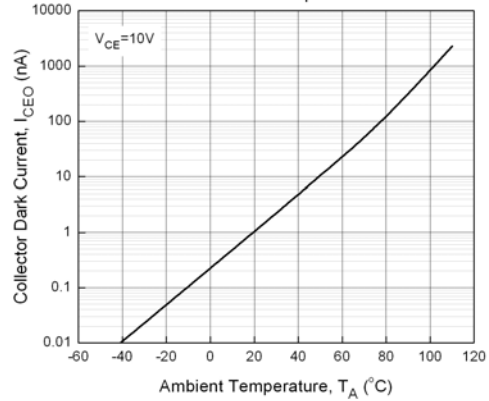

Figure 9. Collector-Emitter Saturation Voltage vs Ambient Temperature

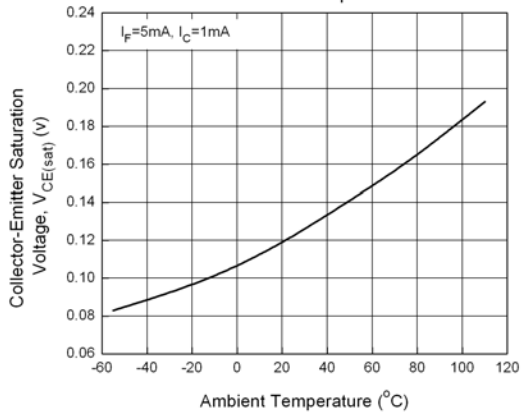

Figure 10. Switching Time vs Load Resistance

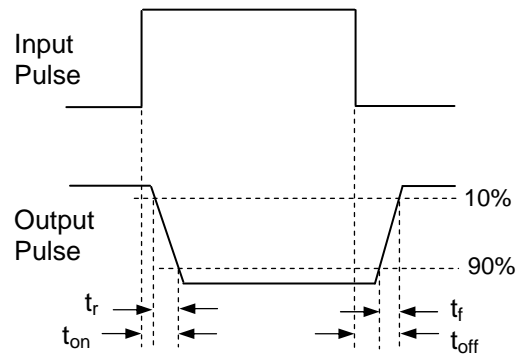
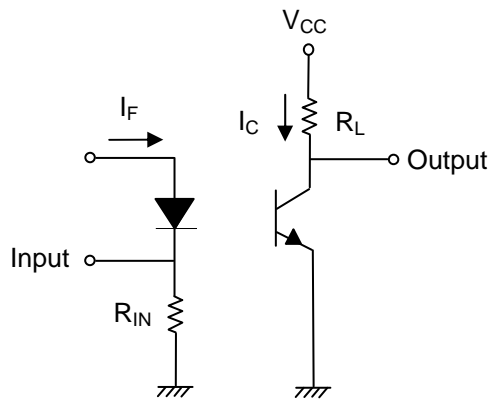
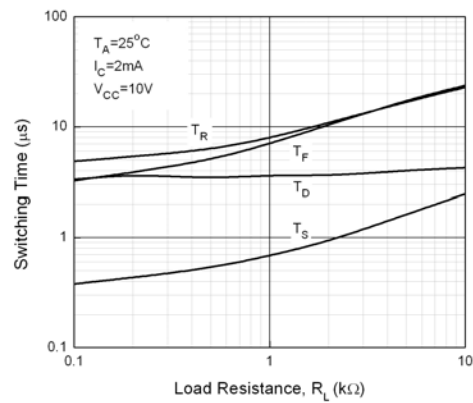

Figure 11. Switching Time Test Circuit & Waveforms



LIGHTING FOREVER

4 PIN SOP PHOTOTRANSISTOR AC INPUT PHOTOCOUPLER

EL3H4-G Series

Order Information

Part Number

EL3H4(X)(Y)-VG

Note

- 3H4 = Part No.
- X = CTR Rank (A or none)
- Y = Tape and reel option (TA, TB, EA, EB or none).
- V = VDE (optional)
- G = Halogens free

Option	Description	Packing quantity
None	Standard SMD option	100 units per tube
-V	Standard SMD option + VDE	100 units per tube
(TA)	TA Tape & reel option	5000 units per reel
(TB)	TB Tape & reel option	5000 units per reel
(TA)-V	TA Tape & reel option + VDE	5000 units per reel
(TB)-V	TB Tape & reel option + VDE	5000 units per reel
(EA)	TA Tape & reel option	1000 units per reel
(EB)	TB Tape & reel option	1000 units per reel
(EA)-V	TA Tape & reel option + VDE	1000 units per reel
(EB)-V	TB Tape & reel option + VDE	1000 units per reel

4 PIN SOP PHOTOTRANSISTOR AC INPUT PHOTOCOUPLER

EL3H4-G Series

Package Drawings (Dimensions in mm)

Package Drawing (Dimensions in mm)

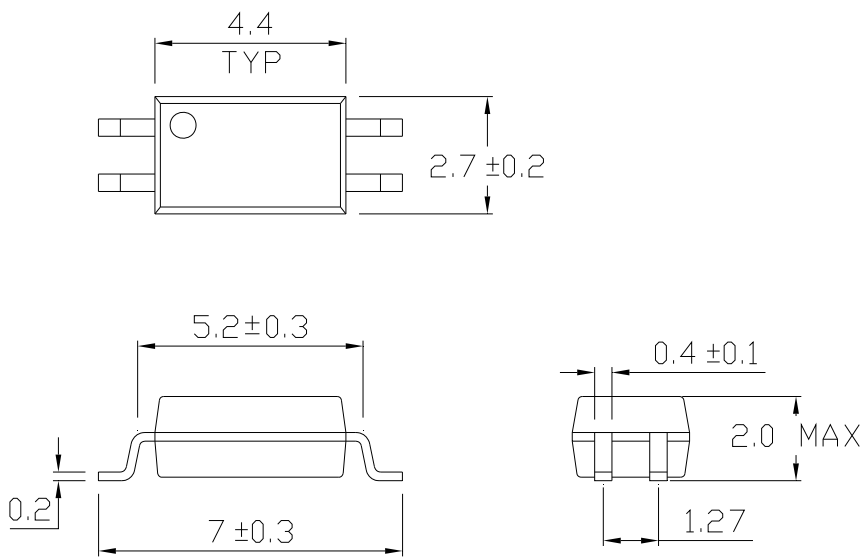

Recommended pad layout for surface mount leadform

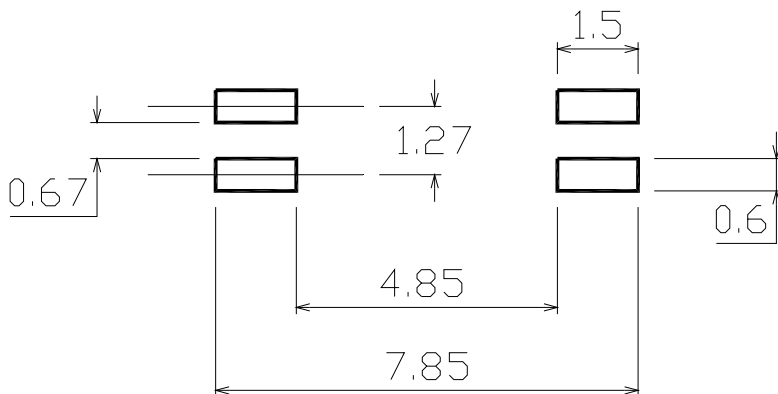



LIGHTING FOREVER

4 PIN SOP PHOTOTRANSISTOR AC INPUT PHOTOCOUPLER

EL3H4-G Series

Device Marking



Notes

- EL denotes Everlight
- 3H4 denotes Part Number
- R denotes CTR Rank (A or none)
- Y denotes 1 digit Year code
- WW denotes 2 digit Week code
- V denotes VDE approved (optional)

4 PIN SOP PHOTOTRANSISTOR AC INPUT PHOTOCOUPLER

EL3H4-G Series

Tape & Reel Packing Specifications

Option TA

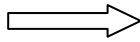
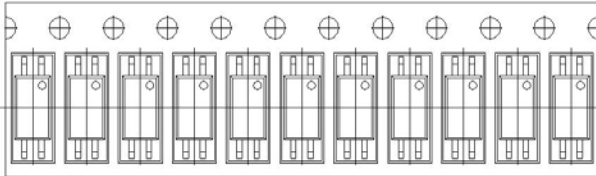

Direction of feed from reel

Option TB

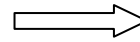
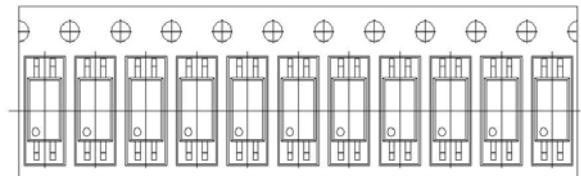

Direction of feed from reel

Tape dimensions

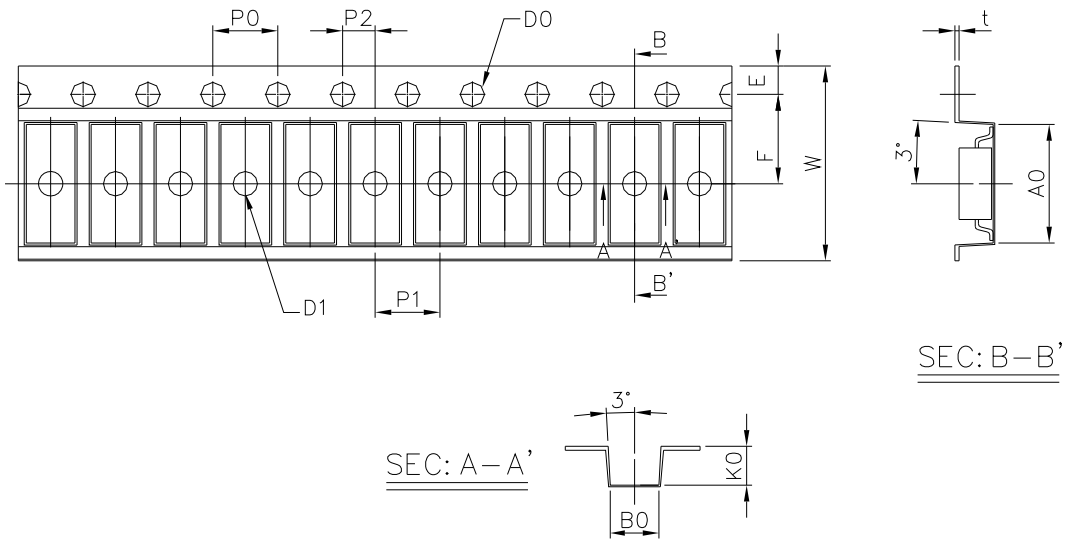

Dimension No.	A	B	Do	D1	E	F
Dimension (mm)	3.0 ± 0.1	7.3 ± 0.1	1.5 + 0.1/-0	1.5 ± 0.1	1.75 ± 0.1	5.5 ± 0.1

Dimension No.	Po	P1	P2	t	W	K
Dimension (mm)	4.0 ± 0.15	4.0 ± 0.1	2.0 ± 0.1	0.25 ± 0.03	12.0 ± 0.2	2.4 ± 0.1

4 PIN SOP PHOTOTRANSISTOR AC INPUT PHOTOCOUPLER

EL3H4-G Series

Solder Reflow Temperature Profile

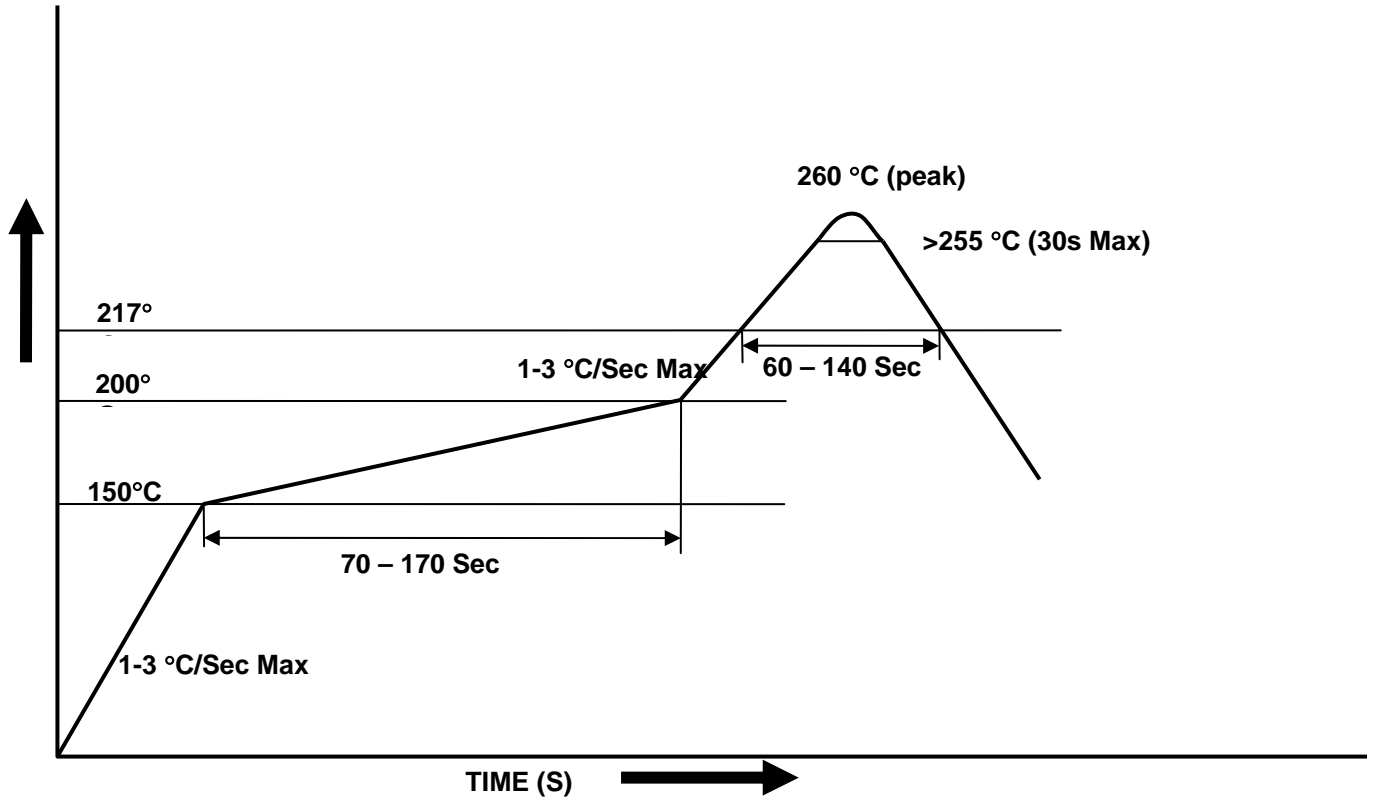



4 PIN SOP PHOTOTRANSISTOR AC INPUT PHOTOCOUPLER

EL3H4-G Series

DISCLAIMER

1. The specifications in this datasheet may be changed without notice. EVERLIGHT reserves the authority on material change for above specification.
2. When using this product, please observe the absolute maximum ratings and the instructions for use as outlined in this datasheet. EVERLIGHT assumes no responsibility for any damage resulting from use of the product which does not comply with the absolute maximum ratings and the instructions included in this datasheet.
3. These specification sheets include materials protected under copyright of EVERLIGHT. Reproduction in any form is prohibited without the specific consent of EVERLIGHT.