

PART No. RCBS1900513

for more information visit
www.hammondmfg.com

Data subject to change without notice

ISOMETRIC VIEW NOT TO SCALE

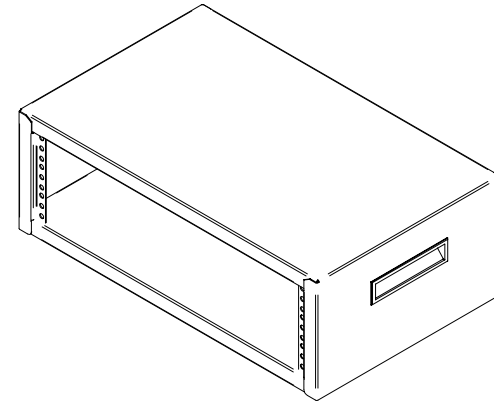

HOLE SPACING PER
EIA-310-D UNIVERSAL

