

**Cool MOS™ Power Transistor**
**Feature**

- New revolutionary high voltage technology
- Ultra low gate charge
- Periodic avalanche rated
- Extreme  $dv/dt$  rated
- High peak current capability
- Intrinsic fast-recovery body diode
- Extreme low reverse recovery charge
- Pb-free lead plating; RoHS compliant
- Qualified according to JEDEC<sup>0)</sup> for target applications

$V_{DS} @ T_{jmax}$	650	V
$R_{DS(on)}$	0.44	$\Omega$
$I_D$	11	A

PG-TO262

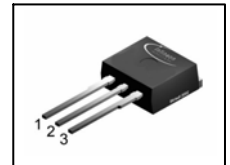

Type	Package	Pb-free	Marking
SPI11N60CFD	PG-TO220	Yes	11N60CFD

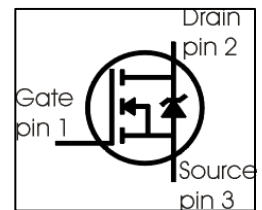
**Maximum Ratings**

Parameter	Symbol	Value	Unit
Continuous drain current $T_C = 25\text{ °C}$ $T_C = 100\text{ °C}$	$I_D$	11 7	A
Pulsed drain current, $t_p$ limited by $T_{jmax}$	$I_{D\text{ puls}}$	28	
Avalanche energy, single pulse $I_D = 5.5\text{ A}$ , $V_{DD} = 50\text{ V}$	$E_{AS}$	340	mJ
Avalanche energy, repetitive $t_{AR}$ limited by $T_{jmax}$ <sup>1)</sup> $I_D = 11\text{ A}$ , $V_{DD} = 50\text{ V}$	$E_{AR}$	0.6	
Avalanche current, repetitive $t_{AR}$ limited by $T_{jmax}$	$I_{AR}$	11	A
Reverse diode $dv/dt$ $I_S = 11\text{ A}$ , $V_{DS} = 480\text{ V}$ , $T_j = 125\text{ °C}$	$dv/dt$	40	V/ns
Gate source voltage	$V_{GS}$	$\pm 20$	V
Gate source voltage AC ( $f > 1\text{ Hz}$ )	$V_{GS}$	$\pm 30$	
Power dissipation, $T_C = 25\text{ °C}$	$P_{tot}$	125	W
Operating and storage temperature	$T_j, T_{stg}$	-55... +150	$\text{°C}$

**Maximum Ratings**

Parameter	Symbol	Value	Unit
Drain Source voltage slope $V_{DS} = 480\text{ V}$ , $I_D = 11\text{ A}$ , $T_j = 125\text{ °C}$	$dv/dt$	80	V/ns
Maximum diode commutation speed $V_{DS} = 480\text{ V}$ , $I_D = 11\text{ A}$ , $T_j = 125\text{ °C}$	$di/dt$	600	A/ $\mu$ s

**Thermal Characteristics**

Parameter	Symbol	Values			Unit
		min.	typ.	max.	
Thermal resistance, junction - case	$R_{thJC}$	-	-	1	K/W
Thermal resistance, junction - ambient, leaded	$R_{thJA}$	-	-	62	
Soldering temperature, wavesoldering 1.6 mm (0.063 in.) from case for 10s	$T_{sold}$	-	-	260	$^{\circ}\text{C}$

**Electrical Characteristics, at  $T_j=25^{\circ}\text{C}$  unless otherwise specified**

Parameter	Symbol	Conditions	Values			Unit
			min.	typ.	max.	
Drain-source breakdown voltage	$V_{(BR)DSS}$	$V_{GS}=0\text{V}$ , $I_D=0.25\text{mA}$	600	-	-	V
Drain-Source avalanche breakdown voltage	$V_{(BR)DS}$	$V_{GS}=0\text{V}$ , $I_D=11\text{A}$	-	700	-	
Gate threshold voltage	$V_{GS(th)}$	$I_D=500\mu\text{A}$ , $V_{GS}=V_{DS}$	3	4	5	
Zero gate voltage drain current	$I_{DSS}$	$V_{DS}=600\text{V}$ , $V_{GS}=0\text{V}$ , $T_j=25^{\circ}\text{C}$ , $T_j=150^{\circ}\text{C}$	-	1.1	-	$\mu\text{A}$
Gate-source leakage current	$I_{GSS}$	$V_{GS}=20\text{V}$ , $V_{DS}=0\text{V}$	-	-	100	nA
Drain-source on-state resistance	$R_{DS(on)}$	$V_{GS}=10\text{V}$ , $I_D=7\text{A}$ , $T_j=25^{\circ}\text{C}$ $T_j=150^{\circ}\text{C}$	-	0.38	0.44	$\Omega$
Gate input resistance	$R_G$	$f=1\text{MHz}$ , open Drain	-	0.86	-	

**Electrical Characteristics** , at  $T_j = 25\text{ }^\circ\text{C}$ , unless otherwise specified

Parameter	Symbol	Conditions	Values			Unit
			min.	typ.	max.	
Transconductance	$g_{fs}$	$V_{DS} \geq 2 \cdot I_D \cdot R_{DS(on)max}$ , $I_D = 7\text{A}$	-	8.3	-	S
Input capacitance	$C_{iss}$	$V_{GS} = 0\text{V}$ , $V_{DS} = 25\text{V}$ , $f = 1\text{MHz}$	-	1200	-	pF
Output capacitance	$C_{oss}$		-	390	-	
Reverse transfer capacitance	$C_{rss}$		-	30	-	
Effective output capacitance, <sup>2)</sup> energy related	$C_{o(er)}$	$V_{GS} = 0\text{V}$ , $V_{DS} = 0\text{V to } 480\text{V}$	-	45	-	pF
Effective output capacitance, <sup>3)</sup> time related	$C_{o(tr)}$		-	85	-	
Turn-on delay time	$t_{d(on)}$	$V_{DD} = 380\text{V}$ , $V_{GS} = 0/10\text{V}$ , $I_D = 11\text{A}$ , $R_G = 6.8\Omega$	-	34	-	ns
Rise time	$t_r$		-	18	-	
Turn-off delay time	$t_{d(off)}$		-	43	-	
Fall time	$t_f$		-	7	-	

**Gate Charge Characteristics**

Gate to source charge	$Q_{gs}$	$V_{DD} = 480\text{V}$ , $I_D = 11\text{A}$	-	9	-	nC
Gate to drain charge	$Q_{gd}$		-	23	-	
Gate charge total	$Q_g$	$V_{DD} = 480\text{V}$ , $I_D = 11\text{A}$ , $V_{GS} = 0\text{ to } 10\text{V}$	-	48	64	
Gate plateau voltage	$V_{(plateau)}$	$V_{DD} = 480\text{V}$ , $I_D = 11\text{A}$	-	7	-	V

<sup>0</sup>J-STD20 and JESD22

<sup>1</sup>Repetitive avalanche causes additional power losses that can be calculated as  $P_{AV} = E_{AR} \cdot f$ .

<sup>2</sup> $C_{o(er)}$  is a fixed capacitance that gives the same stored energy as  $C_{oss}$  while  $V_{DS}$  is rising from 0 to 80%  $V_{DSS}$ .

<sup>3</sup> $C_{o(tr)}$  is a fixed capacitance that gives the same charging time as  $C_{oss}$  while  $V_{DS}$  is rising from 0 to 80%  $V_{DSS}$ .

**Electrical Characteristics, at  $T_j = 25\text{ }^\circ\text{C}$ , unless otherwise specified**

Parameter	Symbol	Conditions	Values			Unit
			min.	typ.	max.	
Inverse diode continuous forward current	$I_S$	$T_C=25^\circ\text{C}$	-	-	11	A
	$I_{SM}$		-	-	28	
Inverse diode forward voltage	$V_{SD}$	$V_{GS}=0\text{V}, I_F=I_S$	-	1	1.2	V
Reverse recovery time	$t_{rr}$	$V_R=480\text{V}, I_F=I_S,$ $di_F/dt=100\text{A}/\mu\text{s}$	-	140	-	ns
Reverse recovery charge	$Q_{rr}$		-	0.7	-	$\mu\text{C}$
Peak reverse recovery current	$I_{rrm}$		-	11	-	A
Peak rate of fall of reverse recovery current	$di_{rr}/dt$		-	1200	-	$\text{A}/\mu\text{s}$

**Typical Transient Thermal Characteristics**

Symbol	Value	Unit	Symbol	Value	Unit
	typ.			typ.	
Thermal resistance			Thermal capacitance		
$R_{th1}$	0.015	K/W	$C_{th1}$	0.0001878	Ws/K
$R_{th2}$	0.03		$C_{th2}$	0.0007106	
$R_{th3}$	0.056		$C_{th3}$	0.000988	
$R_{th4}$	0.197		$C_{th4}$	0.002791	
$R_{th5}$	0.216		$C_{th5}$	0.007285	
$R_{th6}$	0.083		$C_{th6}$	0.063	

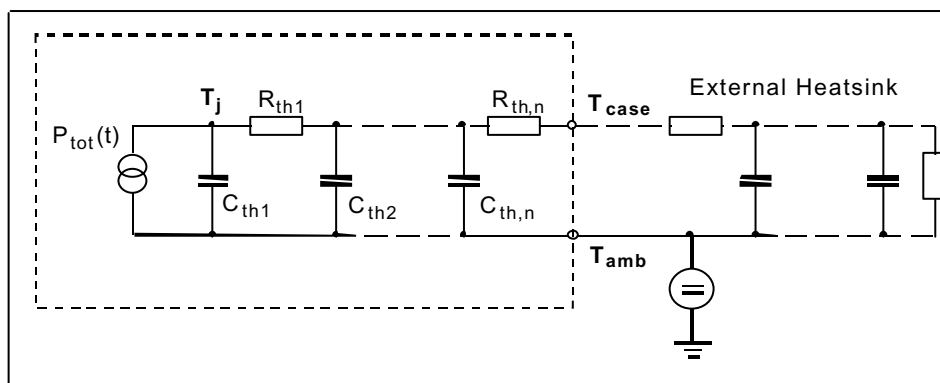

### 1 Power dissipation

$$P_{tot} = f(T_C)$$

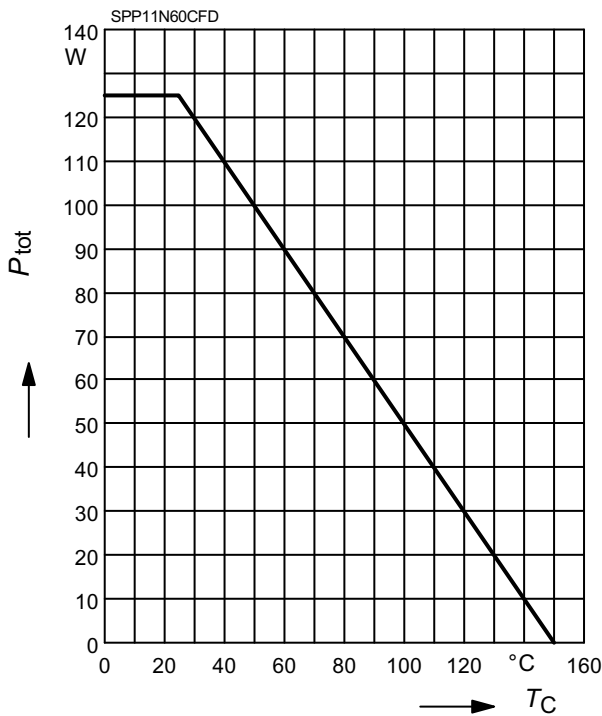

### 2 Safe operating area

$$I_D = f(V_{DS})$$

parameter :  $D = 0, T_C = 25^\circ\text{C}$

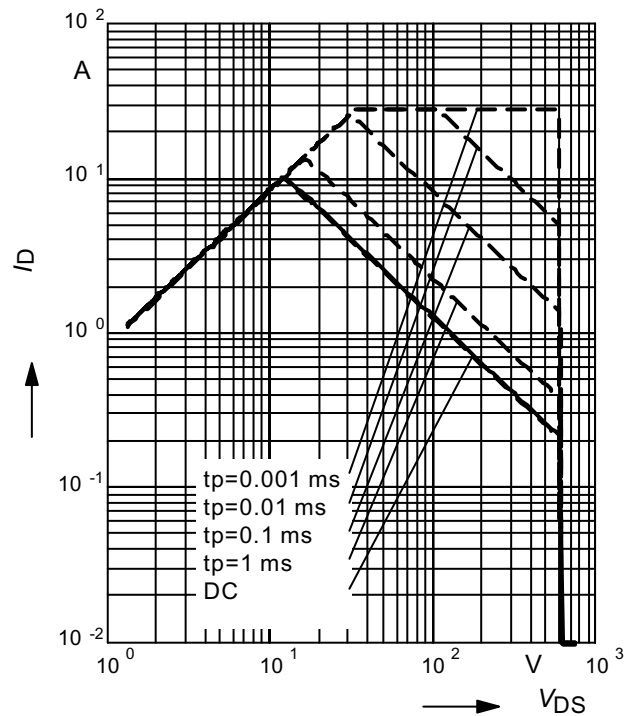

### 3 Transient thermal impedance

$$Z_{thJC} = f(t_p)$$

parameter:  $D = t_p/T$

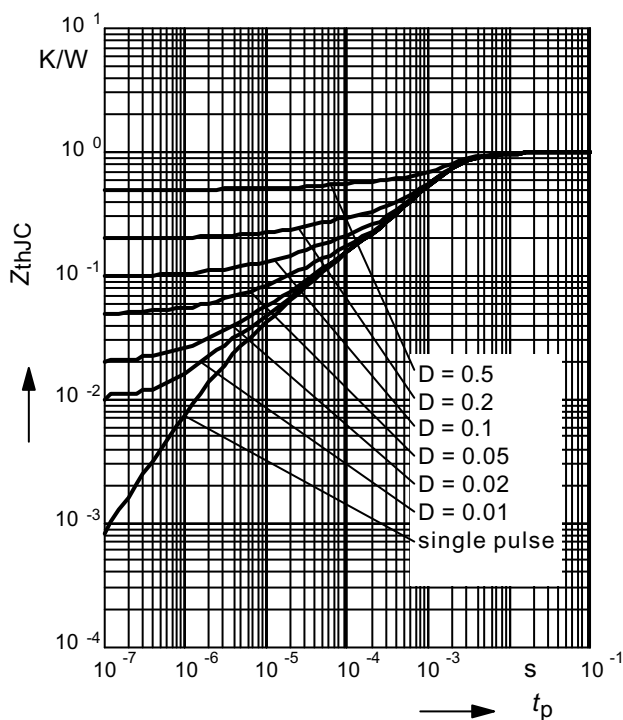

### 4 Typ. output characteristic

$$I_D = f(V_{DS}); T_j = 25^\circ\text{C}$$

parameter:  $t_p = 10 \mu\text{s}, V_{GS}$

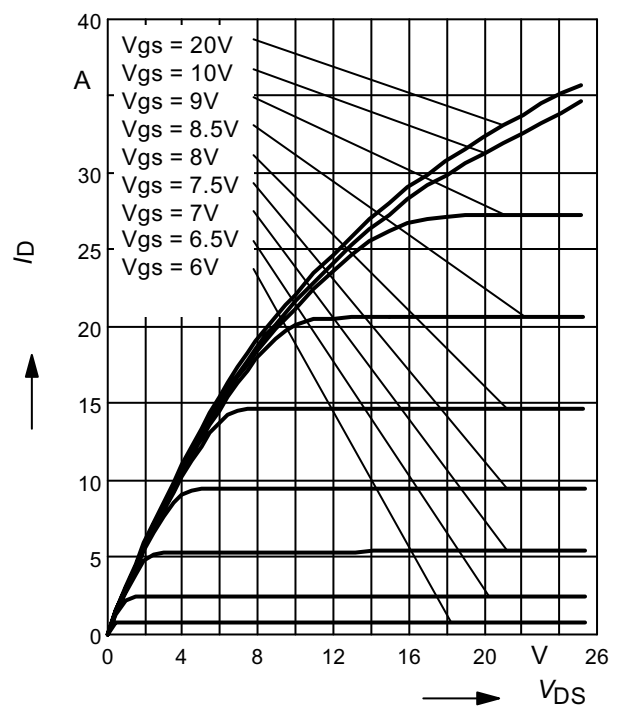

**5 Typ. output characteristic**

$I_D = f(V_{DS}); T_j = 150^\circ\text{C}$

parameter:  $t_p = 10 \mu\text{s}$ ,  $V_{GS}$

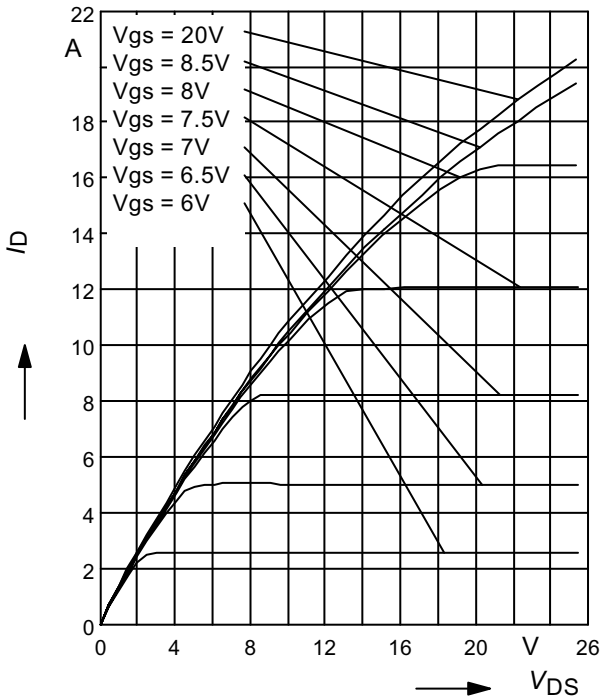

**6 Typ. drain-source on resistance**

$R_{DS(on)} = f(I_D)$

parameter:  $T_j = 150^\circ\text{C}$ ,  $V_{GS}$

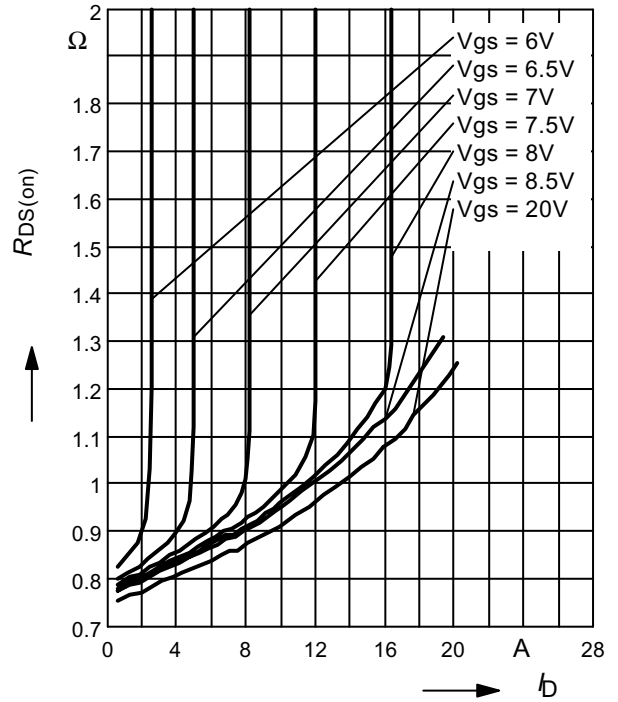

**7 Drain-source on-state resistance**

$R_{DS(on)} = f(T_j)$

parameter:  $I_D = 7 \text{ A}$ ,  $V_{GS} = 10 \text{ V}$

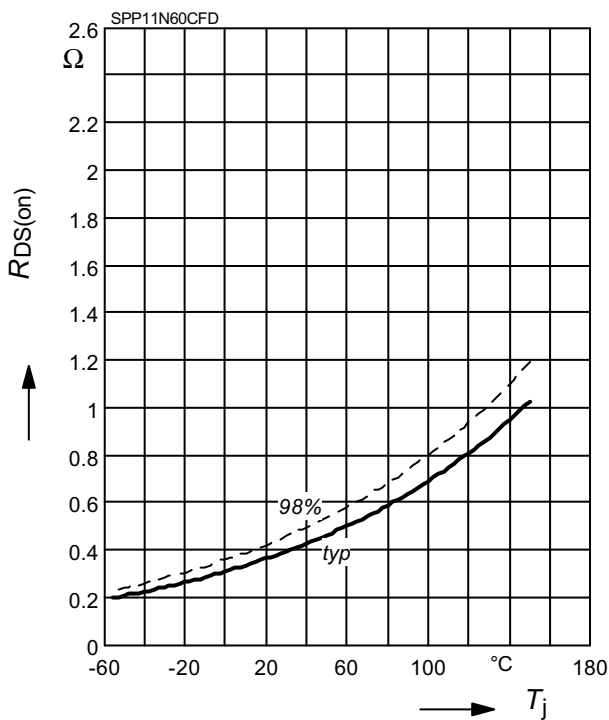

**8 Typ. transfer characteristics**

$I_D = f(V_{GS}); V_{DS} \geq 2 \times I_D \times R_{DS(on)max}$

parameter:  $t_p = 10 \mu\text{s}$

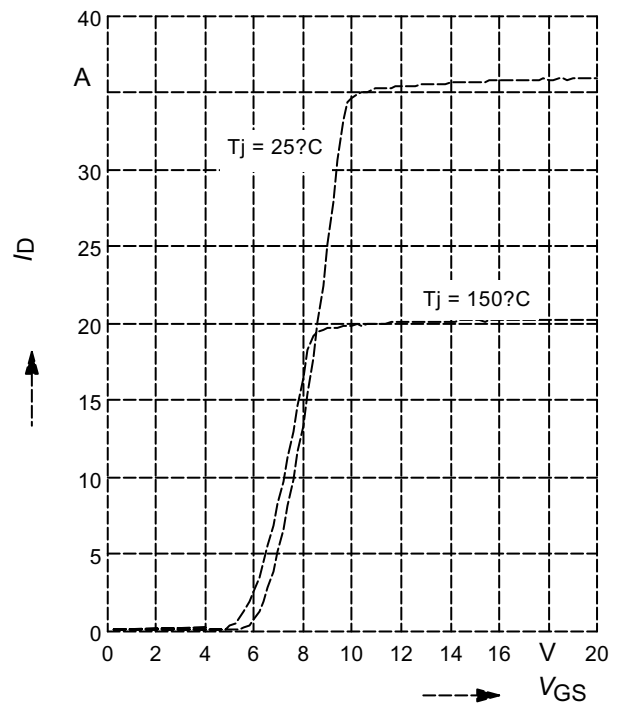

**9 Typ. gate charge**

$V_{GS} = f(Q_{Gate})$

parameter:  $I_D = 11\text{ A}$  pulsed

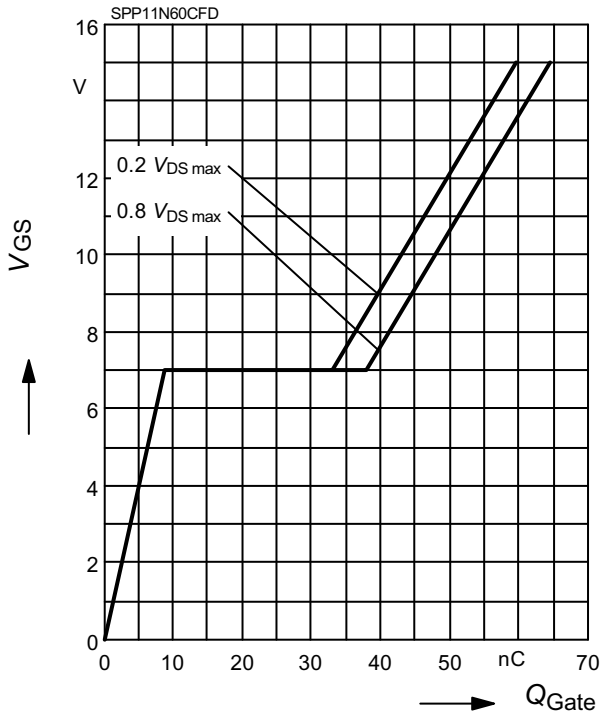

**10 Forward characteristics of body diode**

$I_F = f(V_{SD})$

parameter:  $T_j, t_p = 10\ \mu\text{s}$

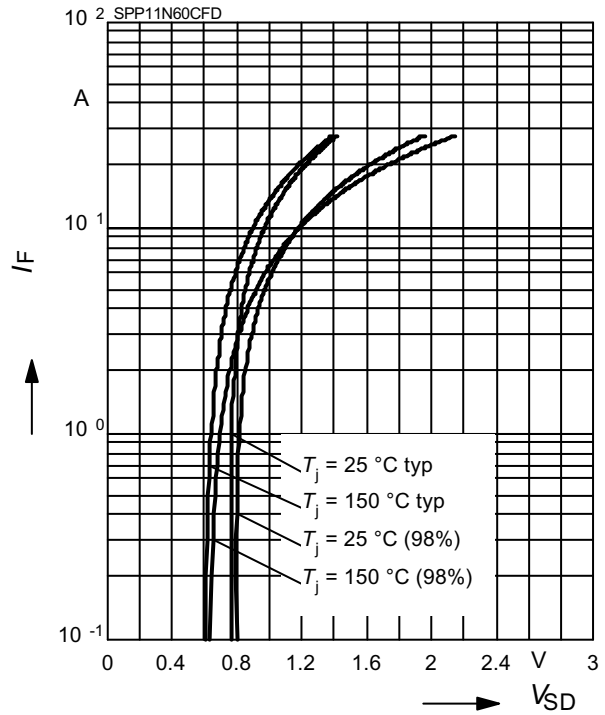

**11 Avalanche SOA**

$I_{AR} = f(t_{AR})$

par.:  $T_j \leq 150\ \text{°C}$

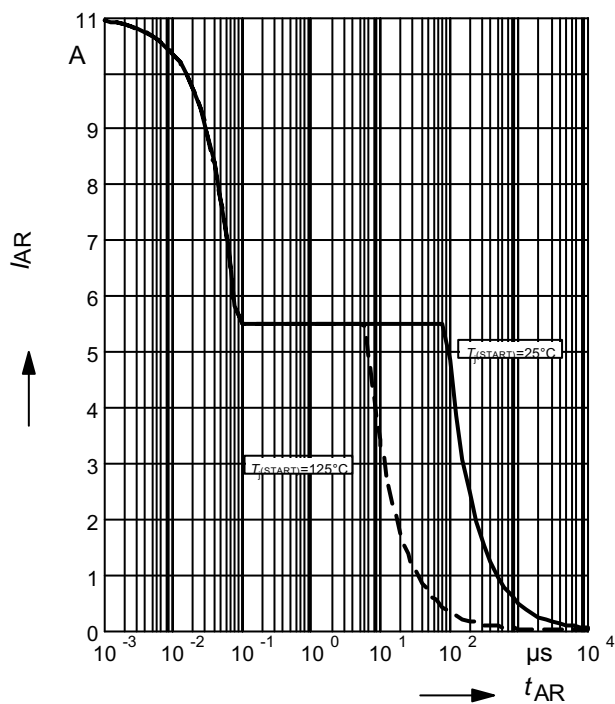

**12 Avalanche energy**

$E_{AS} = f(T_j)$

par.:  $I_D = 5.5\text{ A}, V_{DD} = 50\text{ V}$

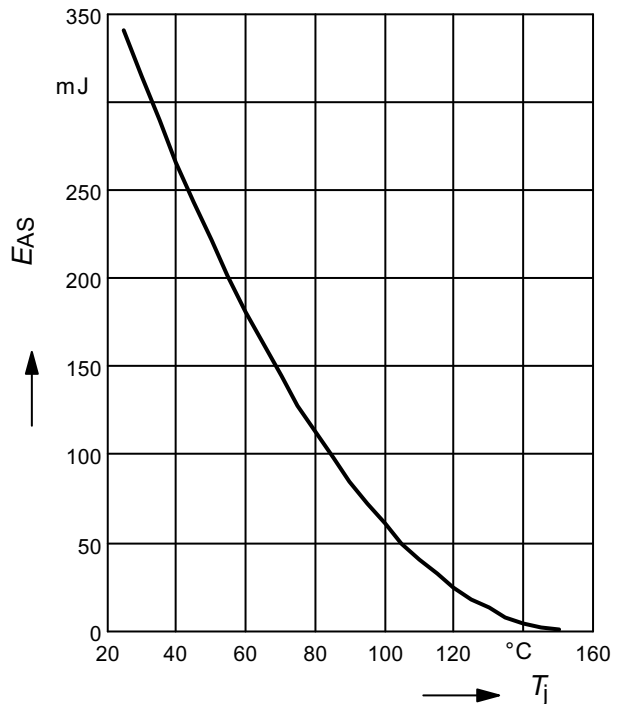

**13 Drain-source breakdown voltage**

$$V_{(BR)DSS} = f(T_j)$$

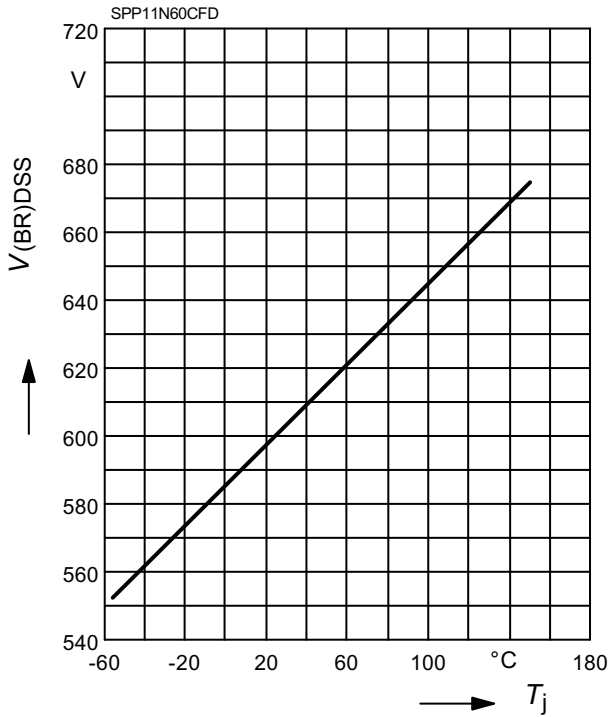

**14 Avalanche power losses**

$$P_{AR} = f(f)$$

parameter:  $E_{AR}=0.6mJ$

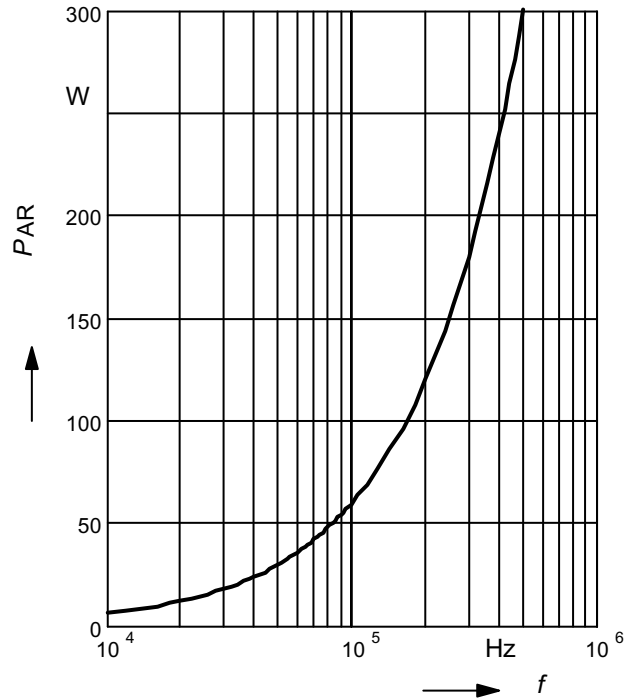

**15 Typ. capacitances**

$$C = f(V_{DS})$$

parameter:  $V_{GS}=0V, f=1\text{ MHz}$

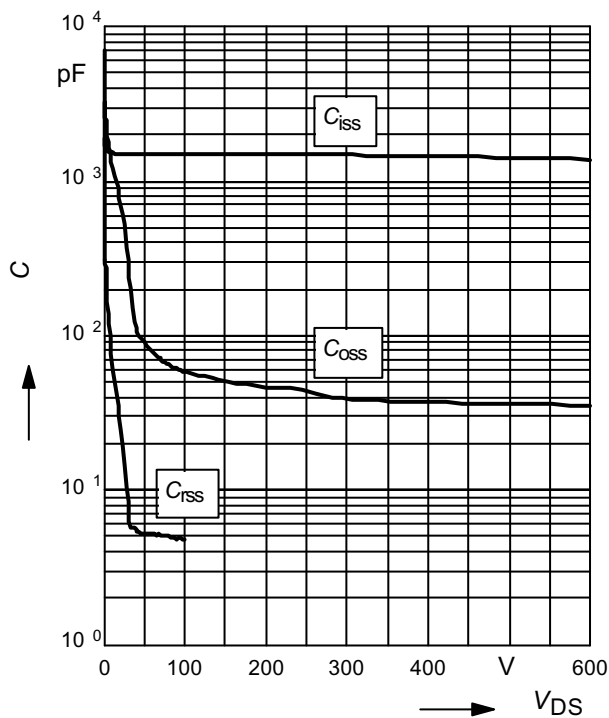

**16 Typ.  $C_{OSS}$  stored energy**

$$E_{OSS} = f(V_{DS})$$

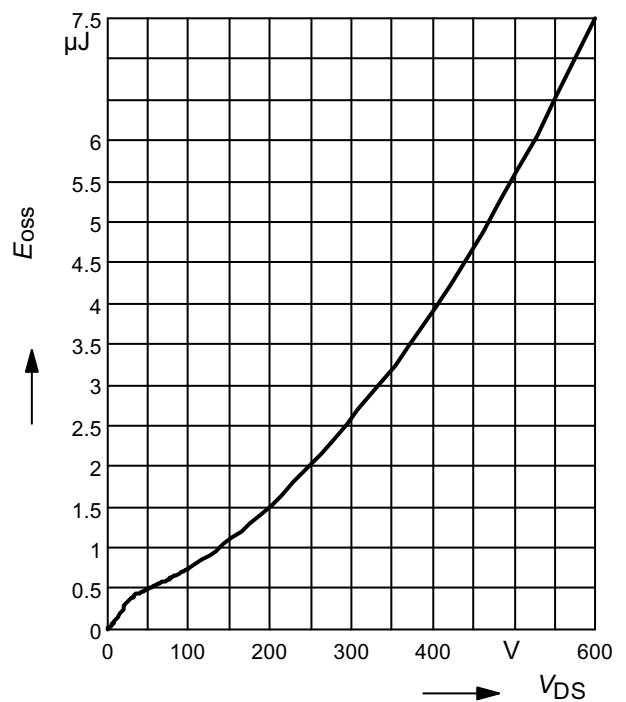



**17 Typ. reverse recovery charge**

$$Q_{rr} = f(T_j)$$

parameter:  $I_D = 11\text{ A}$

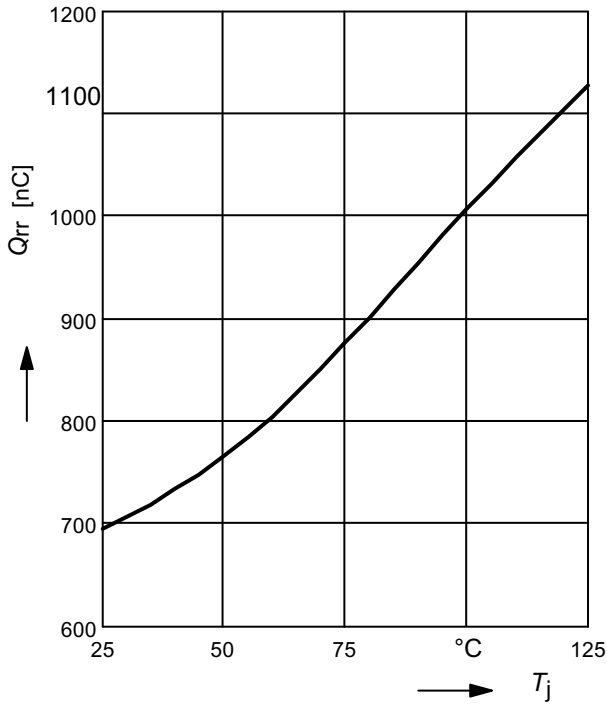

**18 Typ. reverse recovery charge**

$$Q_{rr} = f(I_D)$$

parameter:  $di/dt = 100\text{ A}/\mu\text{s}$

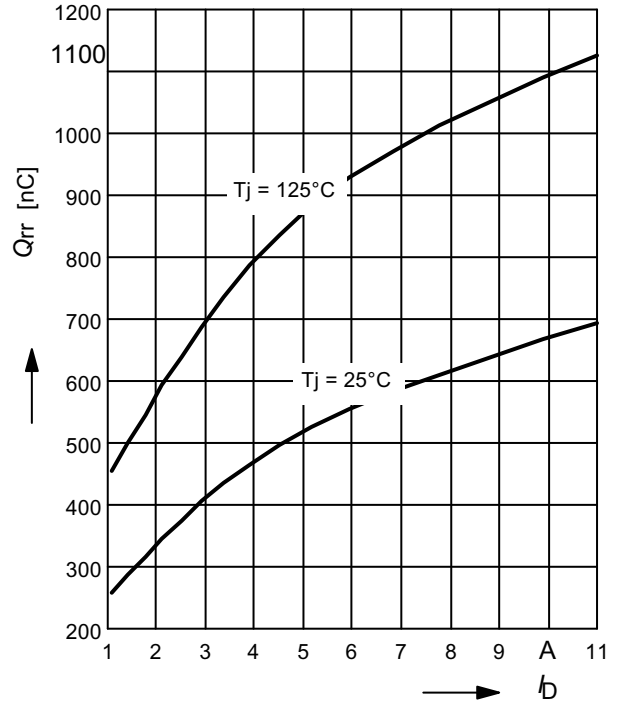

**19 Typ. reverse recovery charge**

$$Q_{rr} = f(di/dt)$$

parameter:  $I_D = 11\text{ A}$

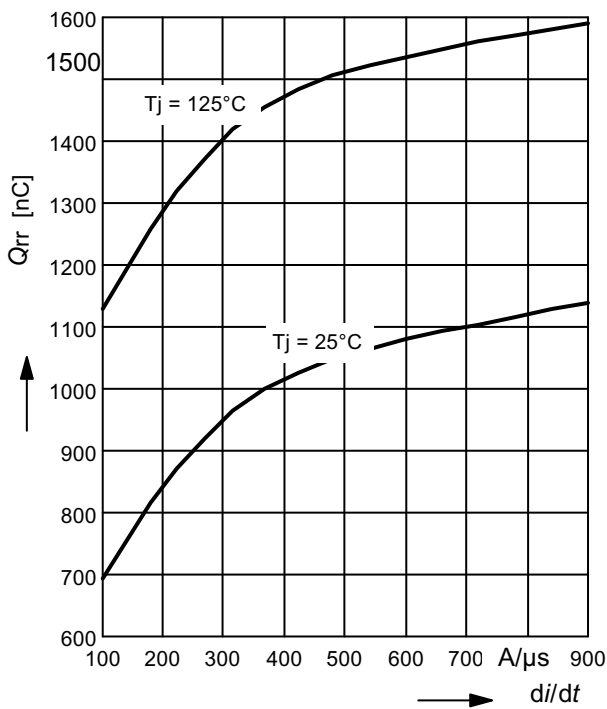

Definition of diodes switching characteristics

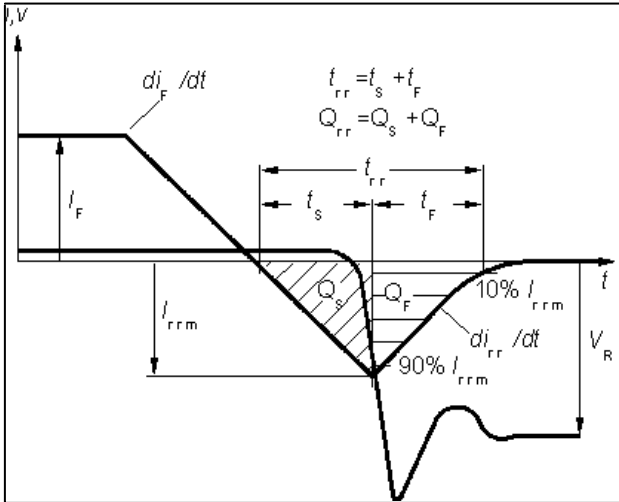

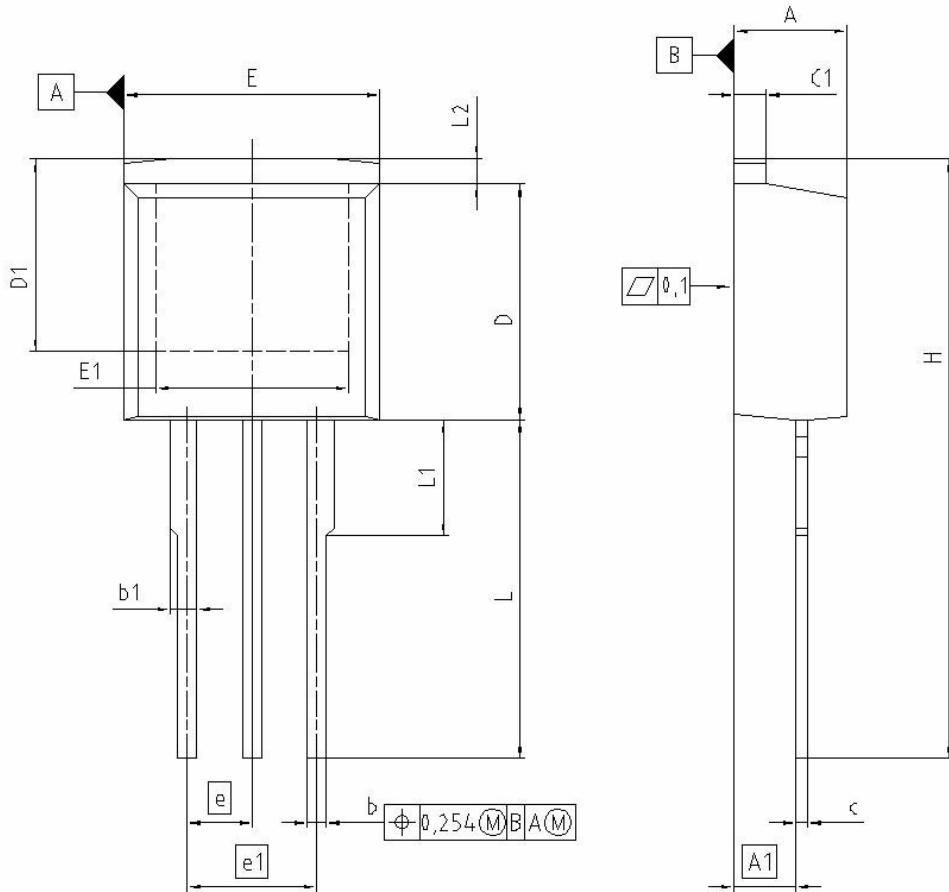

DIM	MILLIMETERS		INCHES	
	MIN	MAX	MIN	MAX
A	4.300	4.500	0.169	0.177
A1	2.150	2.650	0.085	0.104
b	0.650	0.850	0.026	0.033
b1	0.635	1.400	0.025	0.055
c	0.400	0.600	0.016	0.024
c1	1.170	1.370	0.046	0.054
D	9.050	9.450	0.356	0.372
D1	6.900	7.650	0.272	0.301
E	9.800	10.200	0.386	0.402
E1	7.250	8.600	0.285	0.339
e	2.540		0.100	
e1	5.080		0.200	
N	3		3	
L	13.000	14.000	0.512	0.551
L1	4.350	4.750	0.171	0.187
L2	0.700	1.300	0.028	0.051

**REFERENCE**  
JEDEC TO262

**SCALE**

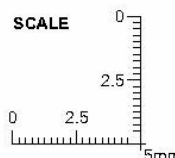

**EUROPEAN PROJECTION**

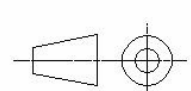

**ISSUE DATE**  
01-06-2005

**FILE**  
TO262\_1



**Published by**  
**Infineon Technologies AG,**  
**Bereichs Kommunikation**  
**St.-Martin-Strasse 53,**  
**D-81541 München**  
**© Infineon Technologies AG 1999**  
**All Rights Reserved.**

**Attention please!**

The information herein is given to describe certain components and shall not be considered as warranted characteristics.

Terms of delivery and rights to technical change reserved.

We hereby disclaim any and all warranties, including but not limited to warranties of non-infringement, regarding circuits, descriptions and charts stated herein.

Infineon Technologies is an approved CECC manufacturer.

**Information**

For further information on technology, delivery terms and conditions and prices please contact your nearest Infineon Technologies Office in Germany or our Infineon Technologies Representatives worldwide (see address list).

**Warnings**

Due to technical requirements components may contain dangerous substances.

For information on the types in question please contact your nearest Infineon Technologies Office.

Infineon Technologies Components may only be used in life-support devices or systems with the express written approval of Infineon Technologies, if a failure of such components can reasonably be expected to cause the failure of that life-support device or system, or to affect the safety or effectiveness of that device or system. Life support devices or systems are intended to be implanted in the human body, or to support and/or maintain and sustain and/or protect human life. If they fail, it is reasonable to assume that the health of the user or other persons may be endangered.