

General Description

The MIC39300 and MIC39301 are 3.0A low-dropout linear voltage regulators that provide a low voltage, high-current output with a minimum of external components. Utilizing Micrel's proprietary Super β PNP[®] pass element, the MIC39300/1 offers extremely low dropout (typically 400mV at 3.0A) and low ground current (typically 36mA at 3.0A).

The MIC39300/1 is ideal for PC add-in cards that need to convert from standard 3.3V to 2.5V or 2.5V to 1.8V. A guaranteed maximum dropout voltage of 500mV over all operating conditions allows the MIC39300/1 to provide 2.5V from a supply as low as 3V, and 1.8V from a supply as low as 2.5V. The MIC39300/1 also has fast transient response for heavy switching applications. The device requires only 47 μ F of output capacitance to maintain stability and achieve fast transient response.

The MIC39300/1 is fully protected with overcurrent limiting, thermal shutdown, reversed-battery protection, reversed-leakage protection, and reversed-lead insertion. The MIC39301 offers a TTL-logic compatible enable pin and an error flag that indicates under voltage and over current conditions. Offered in fixed voltages, the MIC39300/1 comes in the TO-220 and TO-263 packages and is an ideal upgrade to older, NPN-based linear voltage regulators.

For applications with input voltage 6V or below, see MIC3730x LDOs.

Features

- 3.0A minimum guaranteed output current
- 500mV maximum dropout voltage over temperature
 - **Ideal for 3.0V to 2.5V conversion**
 - **Ideal for 2.5V to 1.8V conversion**
- 1% initial accuracy
- Low ground current
- Current limiting and Thermal shutdown
- Reversed-battery protection
- Reversed-leakage protection
- Fast transient response
- TO-263 and TO-220 packaging
- TTL/CMOS compatible enable pin (MIC39301 only)
- Error flag output (MIC39301 only)

Applications

- LDO linear regulator for PC add-in cards
- High-efficiency linear power supplies
- SMPS post regulator
- Multimedia and PC processor supplies
- Low-voltage microcontrollers
- StrongARM[™] processor supply

Typical Application

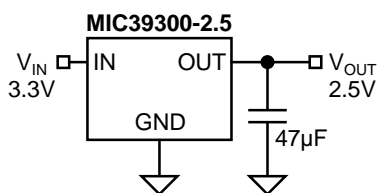

MIC39300

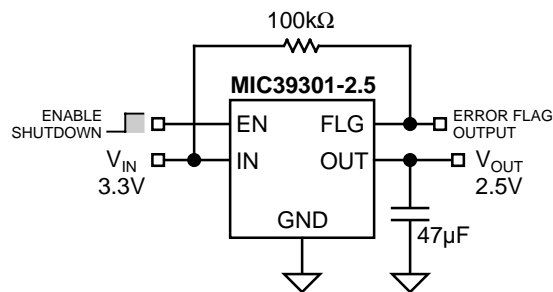

MIC39301

Super β PNP is a registered trademark of Micrel, Inc.
StrongARM is a trademark of Advanced RISC Machines, Ltd.

Ordering Information

Standard	Part Number RoHS Compliant*	Voltage	Junction Temp Range	Package
MIC39300-1.8BT	MIC39300-1.8WT*	1.8V	-40°C to +125°C	3-lead TO-220
MIC39300-1.8BU	MIC39300-1.8WU*	1.8V	-40°C to +125°C	3-lead TO-263
MIC39300-2.5BT	MIC39300-2.5WT*	2.5V	-40°C to +125°C	3-lead TO-220
MIC39300-2.5BU	MIC39300-2.5WU*	2.5V	-40°C to +125°C	3-lead TO-263
MIC39301-1.8BT	MIC39301-1.8WT*	1.8V	-40°C to +125°C	5-lead TO-220
MIC39301-1.8BU	MIC39301-1.8WU*	1.8V	-40°C to +125°C	5-lead TO-263
MIC39301-2.5BT	MIC39301-2.5WT*	2.5V	-40°C to +125°C	5-lead TO-220
MIC39301-2.5BU	MIC39301-2.5WU*	2.5V	-40°C to +125°C	5-lead TO-263

*ROHS compliant with high-melting solder exemption.

Pin Configuration

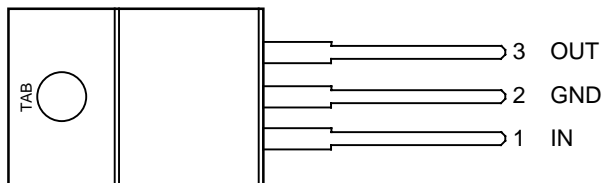

MIC39300-x.xBT
TO-220-3 (T)

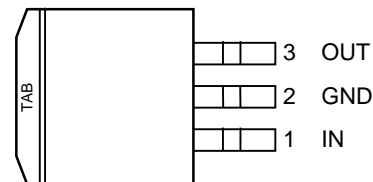

MIC39300-x.xBU
TO-263-3 (U)

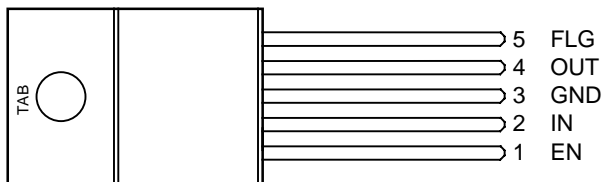

MIC39301-x.xBT
TO-220-5 (T)

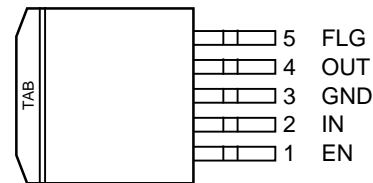

MIC39301-x.xBU
TO-263-5 (U)

Pin Description

Pin Number MIC39300	Pin Number MIC39301	Pin Name	Pin Function
	1	EN	Enable (Input): TTL/CMOS compatible input. Logic high = enable; logic low or open = shutdown.
1	2	IN	Unregulated Input: +16V maximum supply.
2, TAB	3, TAB	GND	Ground: Ground pin and TAB are internally connected.
3	4	OUT	Regulator Output
	5	FLG	Error Flag (Output): Open-collector indicates an output fault condition. Active low.

Absolute Maximum Ratings(1)

Supply Voltage (V_{IN})	-20V to +20V
Enable Voltage (V_{EN})	+20V
Storage Temperature (T_S)	-65°C to +150°C
Lead Temperature (soldering, 5 sec.)	260°C

ESD(3)

Operating Ratings(2)

Supply Voltage (V_{IN})	+2.5V to +16V
Enable Voltage (V_{EN})	+16V
Maximum Power Dissipation ($P_{D(max)}$)	Note 4
Junction Temperature (T_J)	-40°C to +125°C
Package Thermal Resistance	
TO-263 (θ_{JC})	2°C/W
TO-220 (θ_{JC})	2°C/W

Electrical Characteristics

$T_J = 25^\circ\text{C}$, **bold** values indicate $-40^\circ\text{C} \leq T_J \leq +125^\circ\text{C}$, unless noted.

Symbol	Parameter	Condition	Min	Typ	Max	Units
V_{OUT}	Output Voltage	10mA	-1		1	%
		$10\text{mA} \leq I_{OUT} \leq 3\text{A}$, $V_{OUT} + 1\text{V} \leq V_{IN} \leq 8\text{V}$	-2		2	%
	Line Regulation	$I_{OUT} = 10\text{mA}$, $V_{OUT} + 1\text{V} \leq V_{IN} \leq 8\text{V}$		0.06	0.5	%
	Load Regulation	$V_{IN} = V_{OUT} + 1\text{V}$, $10\text{mA} \leq I_{OUT} \leq 3\text{A}$		0.2	1	%
$\Delta V_{OUT}/\Delta T$	Output Voltage Temp. Coefficient(5)			20	100	ppm/°C
V_{DO}	Dropout Voltage(6),(9)	$I_{OUT} = 100\text{mA}$, $\Delta V_{OUT} = -1\%$		65	200	mV
		$I_{OUT} = 750\text{mA}$, $\Delta V_{OUT} = -1\%$		185		mV
		$I_{OUT} = 1.5\text{A}$, $\Delta V_{OUT} = -1\%$		250		mV
		$I_{OUT} = 3\text{A}$, $\Delta V_{OUT} = -1\%$		385	550	mV
I_{GND}	Ground Current(7)	$I_{OUT} = 750\text{mA}$, $V_{IN} = V_{OUT} + 1\text{V}$		10	20	mA
		$I_{OUT} = 1.5\text{A}$, $V_{IN} = V_{OUT} + 1\text{V}$		17		mA
		$I_{OUT} = 3\text{A}$, $V_{IN} = V_{OUT} + 1\text{V}$		45		mA
$I_{GND(do)}$	Dropout Ground Pin Current	$V_{IN} \leq V_{OUT(nominal)} - 0.5\text{V}$, $I_{OUT} = 10\text{mA}$		6		mA
$I_{OUT(lim)}$	Current Limit	$V_{OUT} = 0\text{V}$, $V_{IN} = V_{OUT} + 1\text{V}$		4.5		A

Enable Input (MIC39301)

V_{EN}	Enable Input Voltage	logic low (off)			0.8	V
		logic high (on)	2.5			V
I_{IN}	Enable Input Current	$V_{EN} = 2.5\text{V}$		15	30	μA
		$V_{EN} = 0.8\text{V}$			2	μA
					4	μA
$I_{OUT(shdn)}$	Shutdown Output Current	Note 8		10	20	μA

Flag Output (MIC39301)

$I_{FLG(leak)}$	Output Leakage Current	$V_{OH} = 16\text{V}$		0.01	1	μA
					2	μA
$V_{FLG(do)}$	Output Low Voltage	$V_{IN} = 2.5\text{V}$, $I_{OL} = 250\mu\text{A}$, Note 9		220	300	mV
					400	mV
V_{FLG}	Low Threshold	% of V_{OUT}	93			%
	High Threshold	% of V_{OUT}			99.2	%
	Hysteresis			1		%

Notes:

- Exceeding the absolute maximum ratings may damage the device.
- The device is not guaranteed to function outside its operating rating.
- Devices are ESD sensitive. Handling precautions recommended.
- $P_{D(max)} = (T_J(max) - T_A) \div \theta_{JA}$, where θ_{JA} depends upon the printed circuit layout. See "Applications Information."
- Output voltage temperature coefficient is $\Delta V_{OUT(worst\ case)} \div (T_J(max) - T_J(min))$ where $T_J(max)$ is +125°C and $T_J(min)$ is -40°C.

6. $V_{DO} = V_{IN} - V_{OUT}$ when V_{OUT} decreases to 99% of its nominal output voltage with $V_{IN} = V_{OUT} + 1V$. For output voltages below 2.5V, dropout voltage is the input-to-output voltage differential with the minimum input voltage being 2.5V. Minimum input operating voltage is 2.5V.
7. I_{GND} is the quiescent current. $I_{IN} = I_{GND} + I_{OUT}$.
8. $V_{EN} \leq 0.8V$, $V_{IN} \leq 8V$, and $V_{OUT} = 0V$
9. For a 1.8V device, $V_{IN} = 2.5V$.

Typical Characteristics

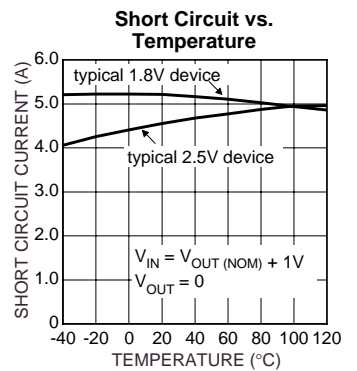
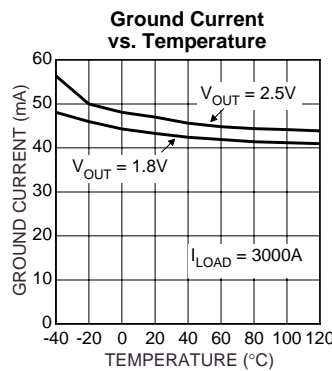
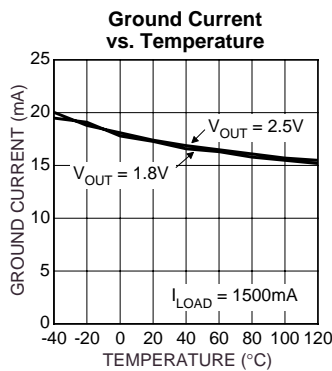
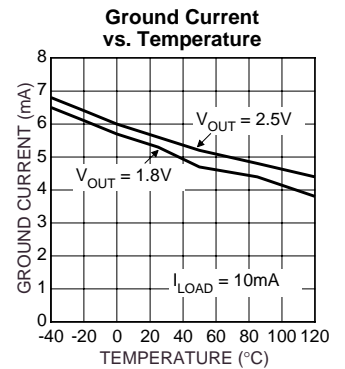
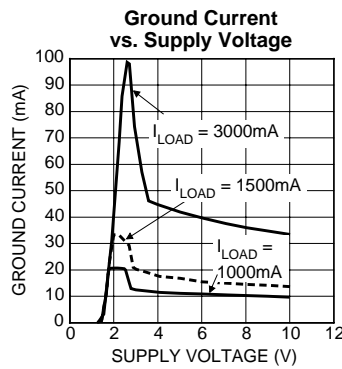
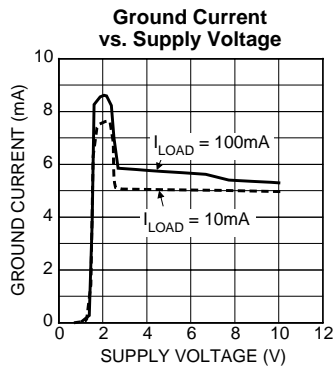
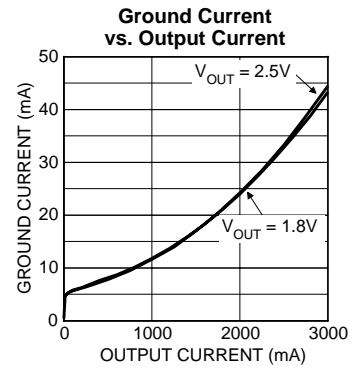
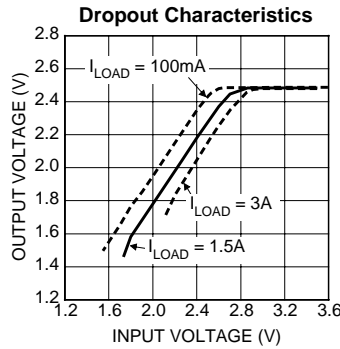
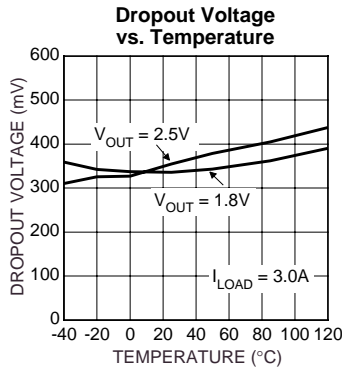
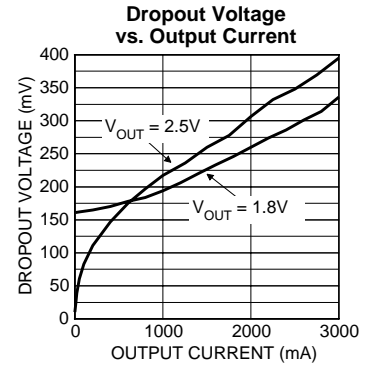
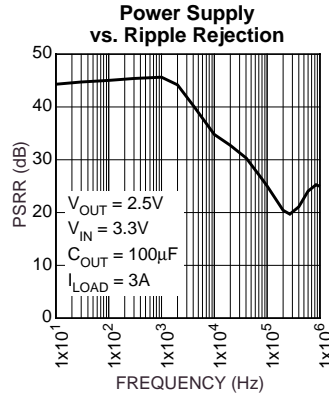
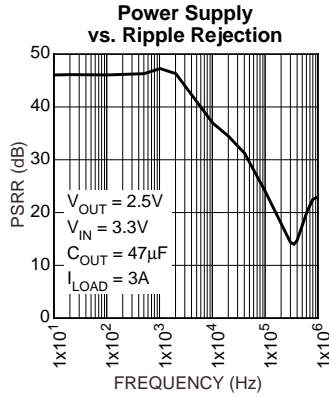

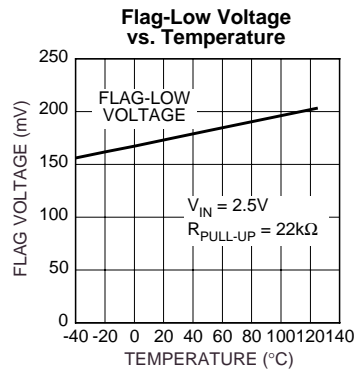
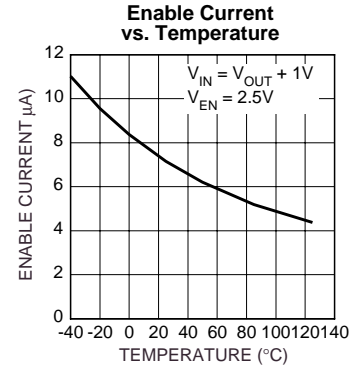
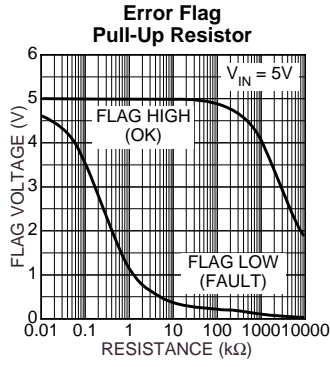
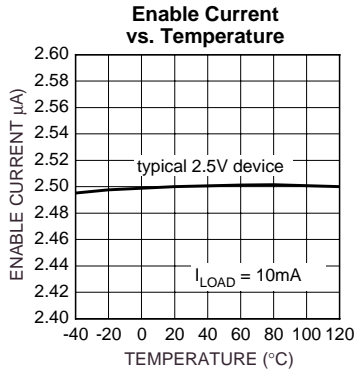

Functional Characteristics

Line Transient Response

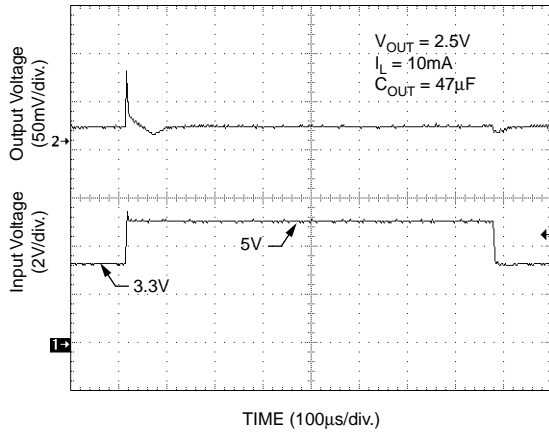

Load Transient Response

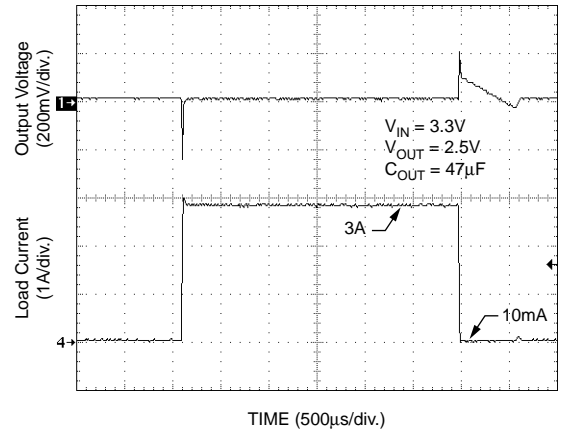

Load Transient Response

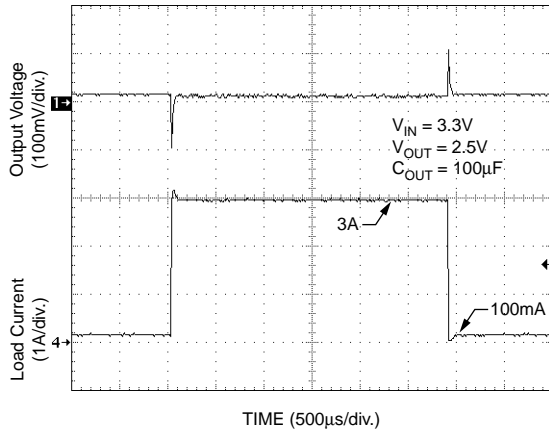

Functional Diagram

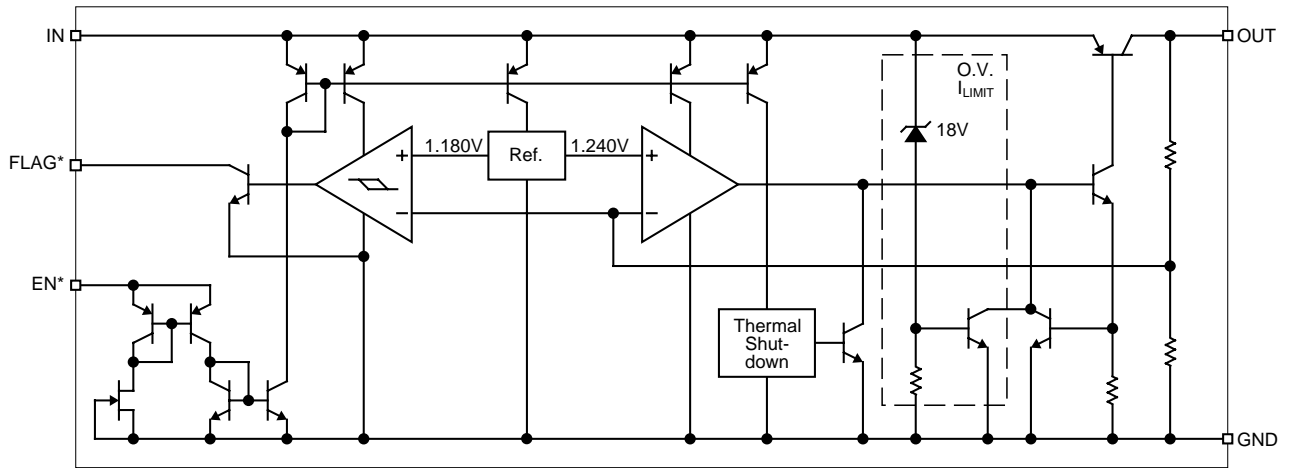

Applications Information

The MIC39300/1 is a high-performance low-dropout voltage regulator suitable for moderate to high-current voltage regulator applications. Its 500mV dropout voltage at full load makes it especially valuable in battery-powered systems and as a high-efficiency noise filter in post-regulator applications. Unlike older NPN-pass transistor designs, where the minimum dropout voltage is limited by the base-to-emitter voltage drop and collector-to-emitter saturation voltage, dropout performance of the PNP output of these devices is limited only by the low V_{CE} saturation voltage.

A trade-off for the low dropout voltage is a varying base drive requirement. Micrel's Super β PNP™ process reduces this drive requirement to only 2% to 5% of the load current.

The MIC39300/1 regulator is fully protected from damage due to fault conditions. Current limiting is provided. This limiting is linear; output current during overload conditions is constant. Thermal shutdown disables the device when the die temperature exceeds the maximum safe operating temperature. Transient protection allows device (and load) survival even when the input voltage spikes above and below nominal. The output structure of these regulators allows voltages in excess of the desired output voltage to be applied without reverse current flow.

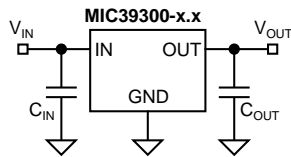

Figure 1. Capacitor Requirements

Thermal Design

Linear regulators are simple to use. The most complicated design parameters to consider are thermal characteristics. Thermal design requires four application-specific parameters:

- Maximum ambient temperature (T_A)
- Output Current (I_{OUT})
- Output Voltage (V_{OUT})
- Input Voltage (V_{IN})
- Ground Current (I_{GND})

Calculate the power dissipation of the regulator from these numbers and the device parameters from this datasheet, where the ground current is taken from the data sheet.

$$P_D = (V_{IN} - V_{OUT}) I_{OUT} + V_{IN} \times I_{GND}$$

The heat sink thermal resistance is determined by:

$$\theta_{SA} = \frac{T_{J(max)} - T_A}{P_D} - (\theta_{JC} + \theta_{CS})$$

where $T_{J(max)} \leq 125^\circ\text{C}$ and θ_{CS} is between 0° and 2°C/W .

The heat sink may be significantly reduced in applications where the minimum input voltage is known and is large compared with the dropout voltage. Use a series input

resistor to drop excessive voltage and distribute the heat between this resistor and the regulator. The low dropout properties of Micrel Super β PNP regulators allow significant reductions in regulator power dissipation and the associated heat sink without compromising performance. When this technique is employed, a capacitor of at least $1.0\mu\text{F}$ is needed directly between the input and regulator ground.

Refer to "Application Note 9" for further details and examples on thermal design and heat sink specification.

Output Capacitor

The MIC39300/1 requires an output capacitor to maintain stability and improve transient response. Proper capacitor selection is important to ensure proper operation. The MIC39300/1 output capacitor selection is dependent upon the ESR (equivalent series resistance) of the output capacitor to maintain stability. When the output capacitor is $47\mu\text{F}$ or greater, the output capacitor should have less than 1Ω of ESR. This will improve transient response as well as promote stability. Ultralow ESR capacitors, such as ceramic chip capacitors may promote instability. These very low ESR levels may cause an oscillation and/or underdamped transient response. A low-ESR solid tantalum capacitor works extremely well and provides good transient response and stability over temperature. Aluminum electrolytics can also be used, as long as the ESR of the capacitor is $\leq 1\Omega$.

The value of the output capacitor can be increased without limit. Higher capacitance values help to improve transient response and ripple rejection and reduce output noise.

Input Capacitor

An input capacitor of $1\mu\text{F}$ or greater is recommended when the device is more than 4 inches away from the bulk ac supply capacitance, or when the supply is a battery. Small, surface-mount, ceramic chip capacitors can be used for the bypassing. Larger values will help to improve ripple rejection by bypassing the input to the regulator, further improving the integrity of the output voltage.

Transient Response and 3.3V to 2.5V and 2.5V to 1.8V Conversions

The MIC39300/1 has excellent transient response to variations in input voltage and load current. The device has been designed to respond quickly to load current variations and input voltage variations. Large output capacitors are not required to obtain this performance. A standard $47\mu\text{F}$ output capacitor, preferably tantalum, is all that is required. Larger values help to improve performance even further.

By virtue of its low-dropout voltage, this device does not saturate into dropout as readily as similar NPN-based designs. When converting from 3.3V to 2.5V or 2.5V to 1.8V, the NPN-based regulators are already operating in dropout, with typical dropout requirements of 1.2V or greater. To convert down to 2.5V without operating in dropout, NPN-based regulators require an input voltage of 3.7V at the very least. The MIC39300/1 regulator will provide excellent performance with an input as low as 3.0V or 2.5V. This gives the PNP-based regulators a distinct advantage over older, NPN-based linear regulators.

Minimum Load Current

The MIC39300/1 regulator is specified between finite loads. If the output current is too small, leakage currents dominate and the output voltage rises. A 10mA minimum load current is necessary for proper regulation.

Error Flag

The MIC39301 version features an error flag circuit which monitors the output voltage and signals an error condition when the voltage drops 5% below the nominal output voltage. The error flag is an open-collector output that can sink 10mA during a fault condition.

Low output voltage can be caused by a number of problems, including an overcurrent fault (device in current limit) or low input voltage. The flag is inoperative during overtemperature shutdown.

When the error flag is not used, it is best to leave it open. The flag pin can be tied directly to pin 4, the output pin.

Enable Input

The MIC39301 version features an enable input for on/off control of the device. Its shutdown state draws “zero” current (only microamperes of leakage). The enable input is TTL/CMOS compatible for simple logic interface, but can be connected to up to 20V. When enabled, it draws approximately 15 μ A.

Package Information

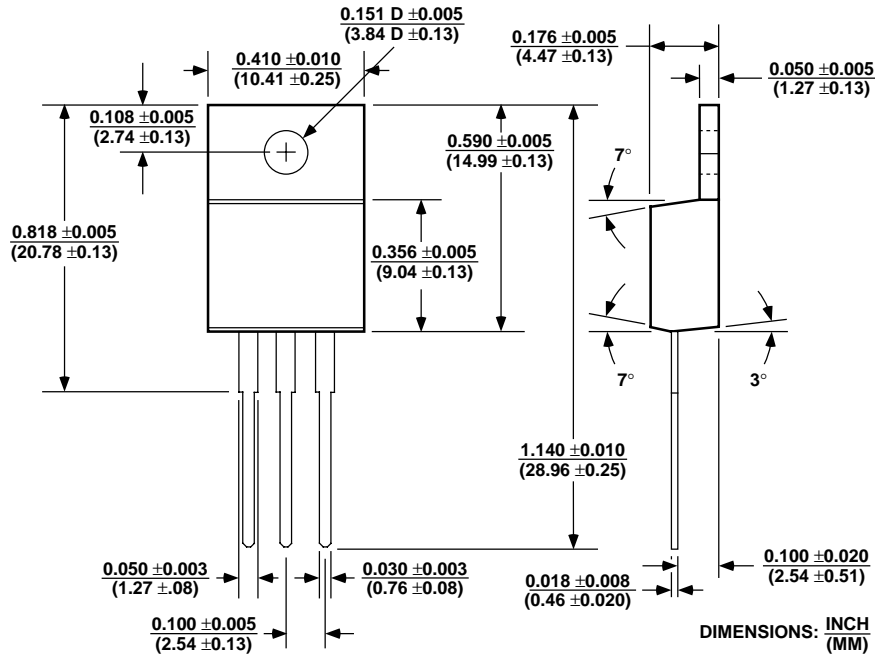

3-Lead TO-220 (T)

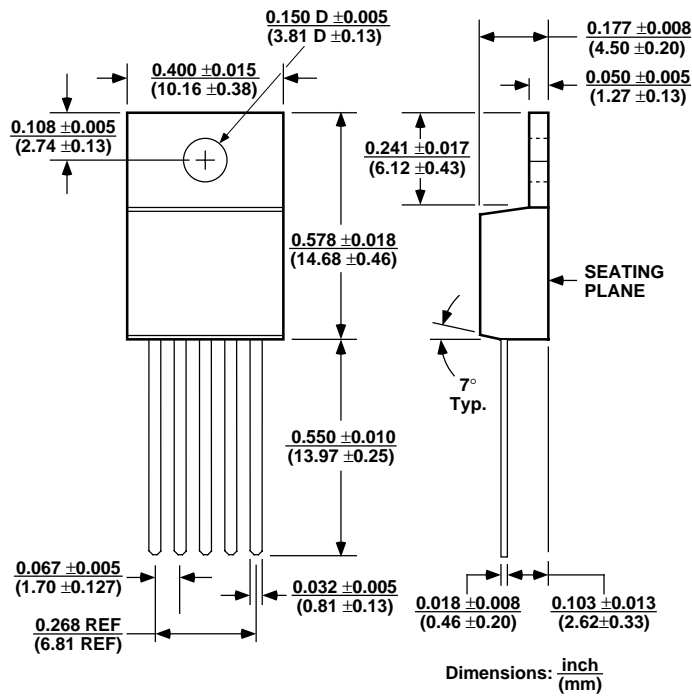

5-Lead TO-220-5 (T)

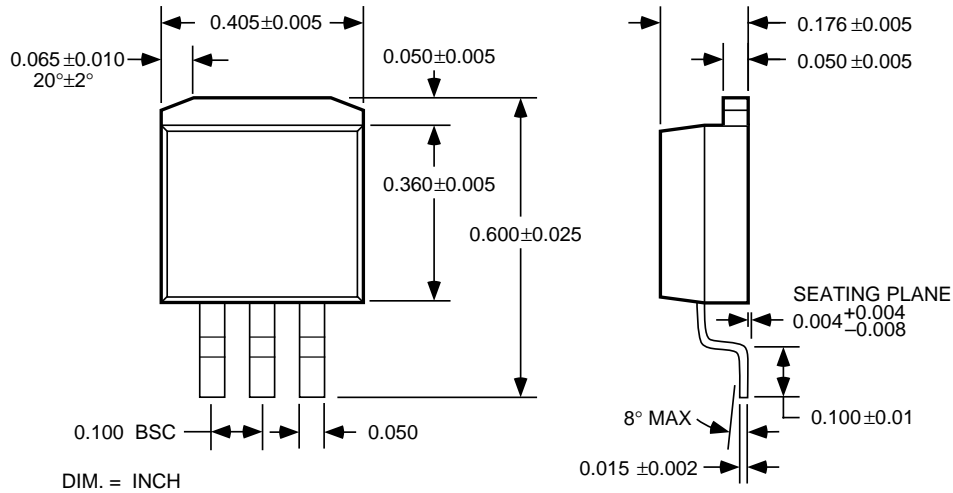

3-Lead TO-263 (U)

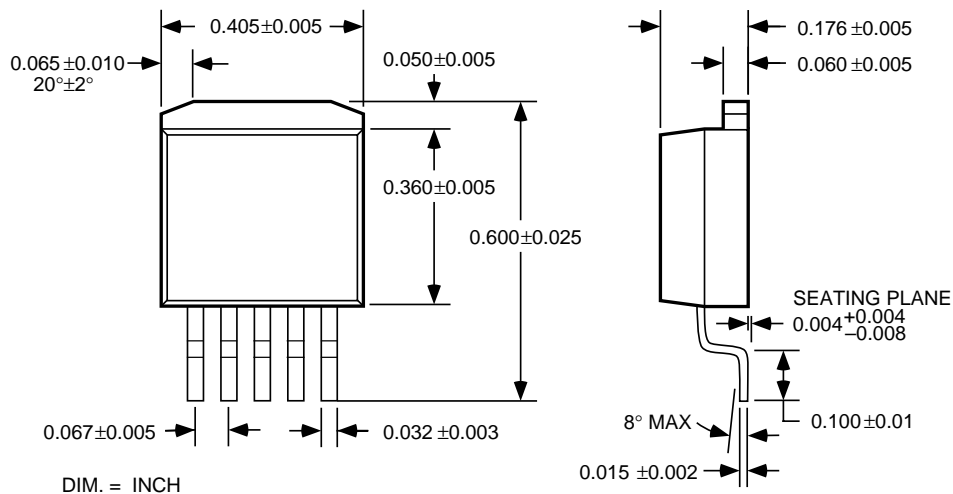

5-Lead TO-263-5 (U)

MICREL INC. 2180 FORTUNE DRIVE SAN JOSE, CA 95131 USA

TEL + 1 (408) 944-0800 FAX + 1 (408) 474-1000 WEB <http://www.micrel.com>

This information furnished by Micrel in this data sheet is believed to be accurate and reliable. However no responsibility is assumed by Micrel for its use. Micrel reserves the right to change circuitry and specifications at any time without notification to the customer.

Micrel Products are not designed or authorized for use as components in life support appliances, devices or systems where malfunction of a product can reasonably be expected to result in personal injury. Life support devices or systems are devices or systems that (a) are intended for surgical implant into the body or (b) support or sustain life, and whose failure to perform can be reasonably expected to result in a significant injury to the user. A Purchaser's use or sale of Micrel Products for use in life support appliances, devices or systems is a Purchaser's own risk and Purchaser agrees to fully indemnify Micrel for any damages resulting from such use or sale.

© 2005 Micrel, Incorporated.