

## Slim and Space-saving Power Plug-in Relay

- Lockable test button models now available.
- Built-in mechanical operation indicator.
- Provided with nameplate.
- AC type is equipped with a coil-disconnection self-diagnostic function (LED type).
- High switching power (1-pole: 10 A).
- Environment-friendly (Cd, Pb free).
- Wide range of Sockets also available.

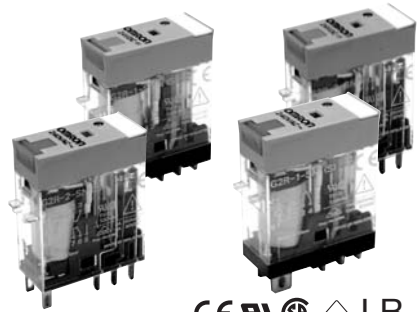

## Model Number Structure

### Model Number Legend

G2R   -       -       -  

1      2      3      4      5      6      7

#### 1. Relay Function

Blank: General purpose

#### 2. Number of Poles

- 1: 1 pole
- 2: 2 pole

#### 3. Contact Form

Blank: SPDT

#### 4. Contact Type

Blank: Single

#### 5. Terminals

S: Plug-in

#### 6. Classification

- Blank: General-purpose
- N: LED indicator
- D: Diode
- ND: LED indicator and diode
- NI: LED indicator with test button
- NDI: LED indicator and diode with test button

#### 7. Rated Coil Voltage

## Ordering Information

### List of Models

Classification		Enclosure rating	Coil ratings	Contact form	
				SPDT	DPDT
Plug-in terminal	General-purpose	Unsealed	AC/DC	G2R-1-S	G2R-2-S
	LED indicator			G2R-1-SN	G2R-2-SN
	LED indicator with test button			G2R-1-SNI	G2R-2-SNI
	Diode		DC	G2R-1-SD	G2R-2-SD
	LED indicator and diode			G2R-1-SND	G2R-2-SND
	LED indicator and diode with test button			G2R-1-SNDI	G2R-2-SNDI

**Note:** When ordering, add the rated coil voltage and "(S)" to the model number. Rated coil voltages are given in the coil ratings table.

Example: G2R-1-S 12 VDC (S) ——— New model  
\_\_\_\_\_ Rated coil voltage

■ Accessories (Order Separately)  
Connecting Sockets

Applicable Relay model	Track/surface-mounting Socket		Back-mounting Socket	
	Screwless clamp terminal	Screw terminal	Terminals	Model
1 pole G2R-1-S(N)(D)(ND)(NI)(NDI)	• P2RF-05S (See note.) + (P2CM-S (option))	• P2RF-05-E • P2RF-05	PCB terminals Solder terminals	P2R-05P, P2R-057P P2R-05A
2 poles G2R-2-S(N)(D)(ND)(NI)(NDI)	• P2RF-08S (See note.) + (P2CM-S (option))	• P2RF-08-E • P2RF-08	PCB terminals Solder terminals	P2R-08P, P2R-087P P2R-08A

Note: Use of the P2CM Clip & Release Lever is recommended to ensure stable mounting.

Accessories for Screwless Clamp Terminal Socket (Option)

Name	Model
Clip & Release Lever	P2CM-S
Nameplate	R99-11 Nameplate for MY
Socket Bridge	P2RM-SR (for AC), P2RM-SB (for DC)

Mounting Tracks

Applicable Socket	Description	Model
Track-connecting Socket	Mounting track	50 cm (ℓ) x 7.3 mm (t); PFP-50N 1 m (ℓ) x 7.3 mm (t); PFP-100N 1 m (ℓ) x 16 mm (t); PFP-100N2
	End plate	PFP-M
	Spacer	PFP-S
Back-connecting Socket	Mounting plate	P2R-P*

\*Used to mount several P2R-05A and P2R-08A Connecting Sockets side by side.

Specifications

■ Coil Ratings

Rated voltage		Rated current*		Coil resistance*	Coil inductance (H) (ref. value)		Must operate voltage	Must release voltage	Max. voltage	Power consumption (approx.)
					Armature OFF	Armature ON				
AC	24 V	43.5 mA	37.4 mA	253 Ω	0.81	1.55	80% max.	30% max.	110%	0.9 VA at 60 Hz
	110 V	9.5 mA	8.2 mA	5,566 Ω	13.33	28.83				
	120 V	8.6 mA	7.5 mA	7,286 Ω	16.13	32.46				
	230 V	4.4 mA	3.8 mA	27,172 Ω	72.68	143.90				
	240 V	3.7 mA	3.2 mA	30,360 Ω	90.58	182.34				

Rated voltage		Rated current*		Coil resistance*	Coil inductance (H) (ref. value)		Must operate voltage	Must release voltage	Max. voltage	Power consumption (approx.)
					Armature OFF	Armature ON				
DC	6 V	87.0 mA		69 Ω	0.25	0.48	70% max.	15% min.	110%	0.53 W
	12 V	43.2 mA		278 Ω	0.98	2.35				
	24 V	21.6 mA		1,113 Ω	3.60	8.25				
	48 V	11.4 mA		4,220 Ω	15.2	29.82				

\* The rated current and coil resistance are measured at a coil temperature of 23°C with tolerances of ±10%.

■ Contact Ratings

<b>Number of poles</b>	1 pole		2 poles	
<b>Load</b>	Resistive load ( $\cos\phi = 1$ )	Inductive load ( $\cos\phi = 0.4$ ; L/R = 7 ms)	Resistive load ( $\cos\phi = 1$ )	Inductive load ( $\cos\phi = 0.4$ ; L/R = 7 ms)
<b>Rated load</b>	10 A at 250 VAC; 10 A at 30 VDC	7.5 A at 250 VAC; 5 A at 30 VDC	5 A at 250 VAC; 5 A at 30 VDC	2 A at 250 VAC; 3 A at 30 VDC
<b>Rated carry current</b>	10 A		5 A	
<b>Max. switching voltage</b>	440 VAC, 125 VDC		380 VAC, 125 VDC	
<b>Max. switching current</b>	10 A		5 A	
<b>Max. switching power</b>	2,500 VA, 300 W	1,875 VA, 150 W	1,250 VA, 150 W	500 VA, 90 W
<b>Failure rate (reference value)</b>	100 mA at 5 VDC		10 mA at 5 VDC	

Note:  $\lambda_1$ : P level:  $\lambda_{G0} = 0.1 \times 10^{-6}$ /operation

■ Characteristics

Item	1 pole	2 poles
<b>Contact resistance</b>	100 mΩ max.	
<b>Operate (set) time</b>	15 ms max.	
<b>Release (reset) time</b>	AC: 10 ms max.; DC: 5 ms max. (w/built-in diode: 20 ms max.)	AC: 15 ms max.; DC: 10 ms max. (w/built-in diode: 20 ms max.)
<b>Max. operating frequency</b>	Mechanical: 18,000 operations/hr Electrical: 1,800 operations/hr (under rated load)	
<b>Insulation resistance</b>	1,000 MΩ min. (at 500 VDC)	
<b>Dielectric strength</b>	5,000 VAC, 50/60 Hz for 1 min between coil and contacts*; 1,000 VAC, 50/60 Hz for 1 min between contacts of same polarity	5,000 VAC, 50/60 Hz for 1 min between coil and contacts*; 3,000 VAC, 50/60 Hz for 1 min between contacts of different polarity 1,000 VAC, 50/60 Hz for 1 min between contacts of same polarity
<b>Vibration resistance</b>	Destruction: 10 to 55 to 10 Hz, 0.75 mm single amplitude (1.5 mm double amplitude) Malfunction: 10 to 55 to 10 Hz, 0.75 mm single amplitude (1.5 mm double amplitude)	
<b>Shock resistance</b>	Destruction: 1,000 m/s <sup>2</sup> Malfunction: 200 m/s <sup>2</sup> when energized; 100 m/s <sup>2</sup> when not energized	
<b>Endurance</b>	Mechanical: AC coil: 10,000,000 operations min.; DC coil: 20,000,000 operations min. (at 18,000 operations/hr) Electrical: 100,000 operations min. (at 1,800 operations/hr under rated load) (DC coil type)	
<b>Ambient temperature</b>	Operating: -40°C to 70°C (with no icing or condensation)	
<b>Ambient humidity</b>	Operating: 5% to 85%	
<b>Weight</b>	Approx. 21 g	

Note: Values given above are initial values

\*4,000 VAC, 50/60 Hz for 1 minute when the P2R-05A or P2R-08A Socket is mounted.

■ Approved Standards

UL 508 (File No. E41643)

Model	Contact form	Coil ratings	Contact ratings	Operations
G2R-1-S	SPDT	5 to 110 VDC 5 to 240 VAC	10 A, 30 VDC (resistive) 10 A, 250 VAC (general use) TV-3 (NO contact only)	6 x 10 <sup>3</sup>
G2R-2-S	DPDT		5 A, 30 VDC (resistive) 5 A, 250 VAC (general use) TV-3 (NO contact only)	6 x 10 <sup>3</sup>

IEC.VDE (EN61810)

Contact form	Coil ratings	Contact ratings	Operations
1 pole	6, 12, 24, 48 VDC 24, 110, 120, 230, 240 VAC	5 A, 440 VAC ( $\cos\phi = 1.0$ ) 10 A, 250 VAC ( $\cos\phi = 1.0$ ) 10 A, 30 VDC (0 ms)	100 x 10 <sup>3</sup>
2 poles	6, 12, 24, 48 VDC 24, 110, 120, 230, 240 VAC	5 A, 250 VAC ( $\cos\phi = 1.0$ ) 5 A, 30 VDC (0 ms)	100 x 10 <sup>3</sup>

CSA 22.2 No.0, No.14

(File No. LR31928)

Model	Contact form	Coil ratings	Contact ratings	Operations
G2R-1-S	SPDT	5 to 110 VDC 5 to 240 VAC	10 A, 30 VDC (resistive) 10 A, 250 VAC (general use) TV-3 (NO contact only)	6 x 10 <sup>3</sup>
G2R-2-S	DPDT		5 A, 30 VDC (resistive) 5 A, 250 VAC (general use) TV-3 (NO contact only)	6 x 10 <sup>3</sup>

LR

Number of poles	Coil ratings	Contact ratings	Operations
1 pole	5 to 110 VDC 5 to 240 VDC	10 A, 250 VAC (general use) 7.5 A, 250 VAC (PF0.4) 10 A, 30 VDC (resistive) 5A, 30VDC (L/R=7ms)	100 x 10 <sup>3</sup>
2 poles	5 to 110 VDC 5 to 240 VDC	5 A, 250 VAC (general use) 2 A, 250 VAC (PF0.4) 5 A, 30 VDC (resistive) 3A, 30VDC (L/R=7ms)	100 x 10 <sup>3</sup>

## Engineering Data

### Maximum Switching Power

Plug-in Relays

G2R-1-S

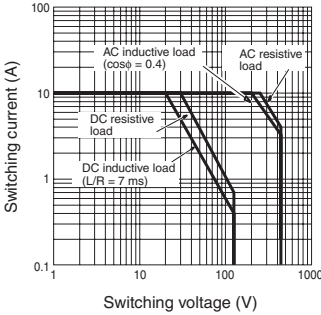

G2R-2-S

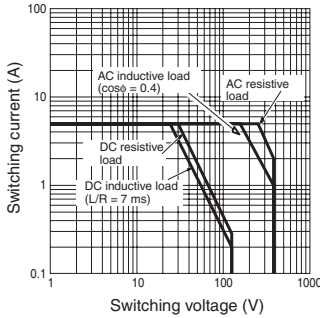

### Endurance

Plug-in Relays

G2R-1-S

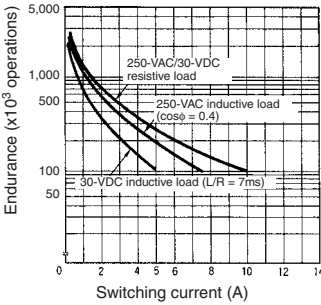

G2R-2-S

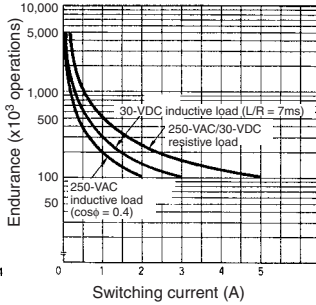

### Ambient Temperature vs Maximum Coil Voltage

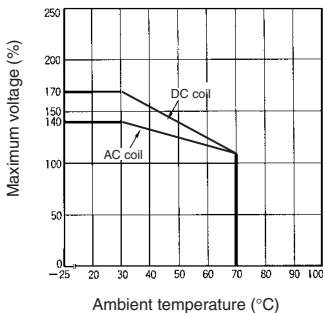

**Note:** The maximum voltage refers to the maximum value in a varying range of operating power voltage, not a continuous voltage.

## Relays with Plug-in Terminals

Note: All units are in millimetres unless otherwise indicated.

### SPDT Relays

G2R-1-S, G2R-1-SN, G2R-1-SNI  
G2R-1-SD, G2R-1-SND, G2R-1-SNDI

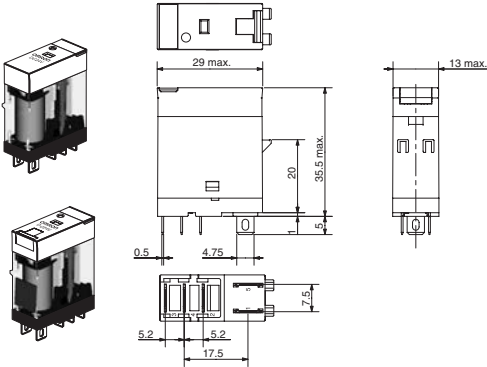

#### Terminal Arrangement/Internal Connections (Bottom View)

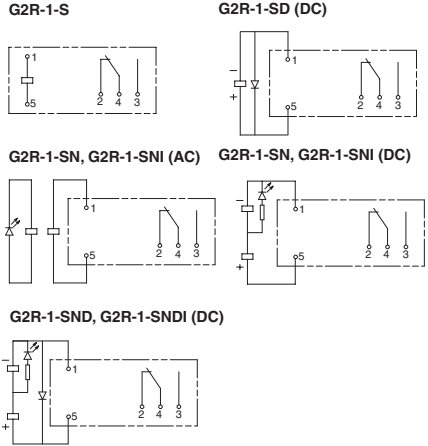

### DPDT Relays

G2R-2-S, G2R-2-SN, G2R-2-SNI  
G2R-2-SD, G2R-2-SND, G2R-2-SNDI

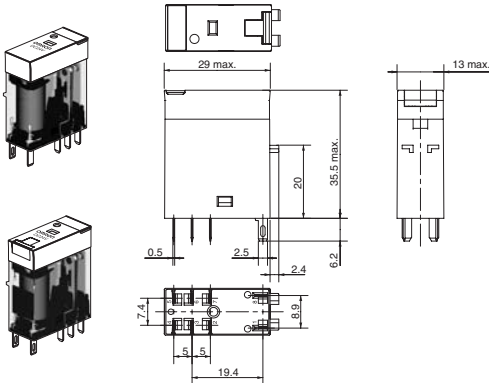

#### Terminal Arrangement/Internal Connections (Bottom View)

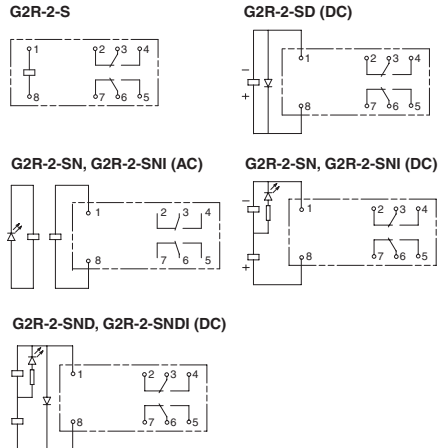

Track/Surface Mounting Sockets

P2RF-05-S

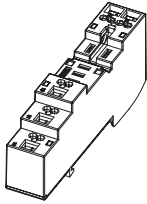

Standard model

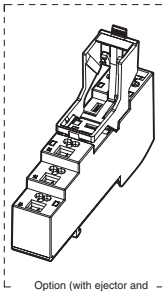

Option (with ejector and label attached)

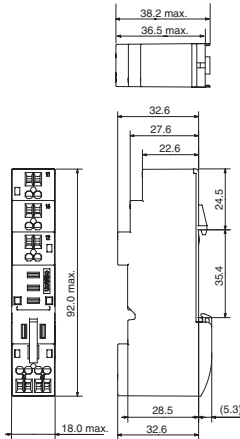

Terminal Arrangement (Top View)

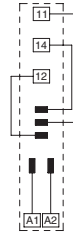

P2RF-08-S

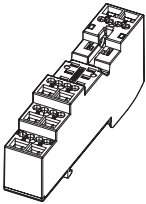

Standard model

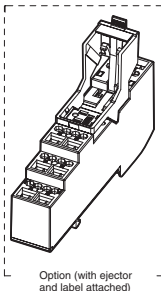

Option (with ejector and label attached)

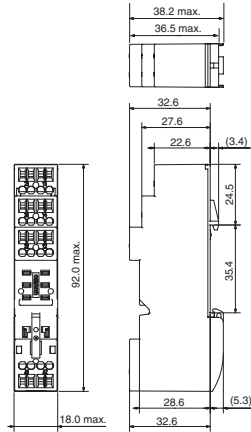

Terminal Arrangement (Top View)

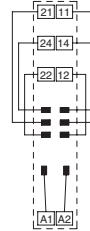

Accessories for P2RF-□-S

Socket Bridge

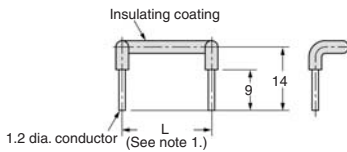

Clip and Reverse Lever

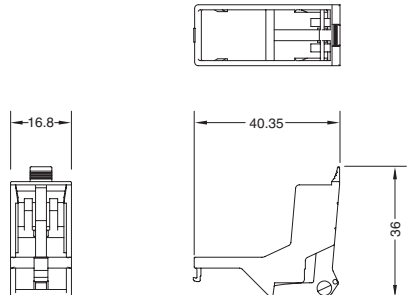

**P2RF-05-E**

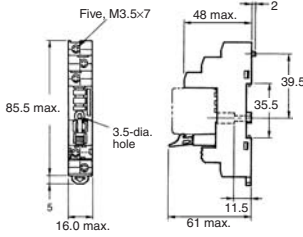
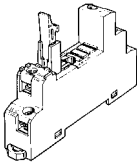

**Terminal Arrangement (Top View)**

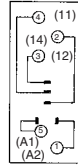

**Mounting Holes (for Surface Mounting)**

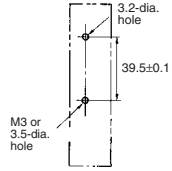

**Note:** Pin numbers in parentheses apply to DIN standard.

**P2RF-08-E**

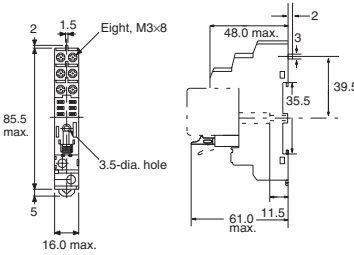
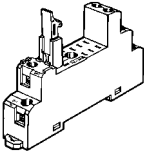

**Terminal Arrangement (Top View)**

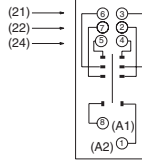

**Mounting Holes (for Surface Mounting)**

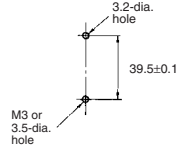

**P2RF-05**

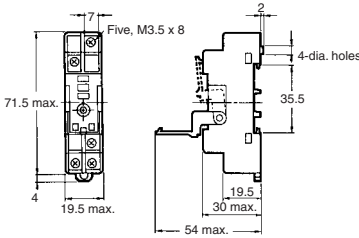
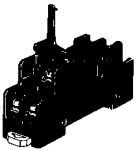

**Terminal Arrangement (Top View)**

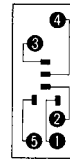

**Mounting Holes (for Surface Mounting)**

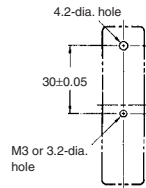

**P2RF-08**

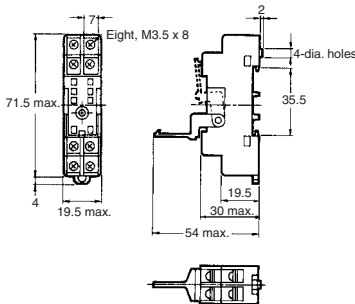
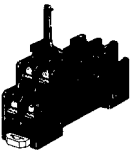

**Terminal Arrangement (Top View)**

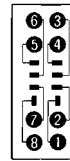

**Mounting Holes (for Surface Mounting)**

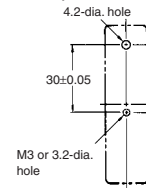

### Mounting Height of Relay with Track/Surface Mounting Sockets

P2RF-□

P2RF-□-E

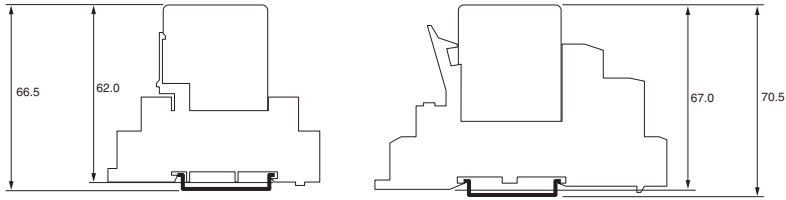

P2RF-□-S

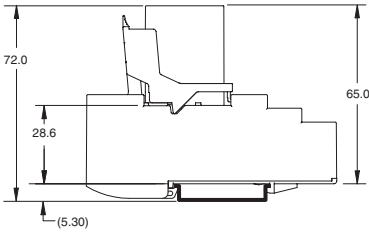

### Back-connecting sockets

P2R-05P (1-pole)

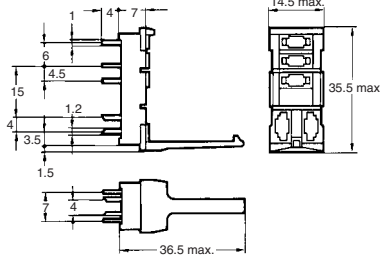
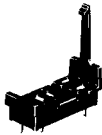

Terminal Arrangement (Bottom View)

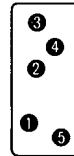

Mounting Holes

Tolerance: ±0.1

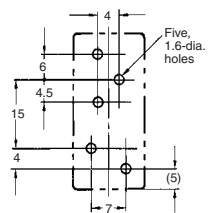

P2R-08P (2-pole)

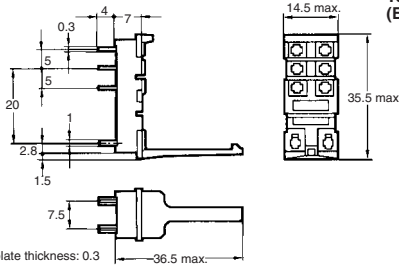
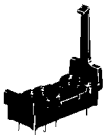

Terminal Arrangement (Bottom View)

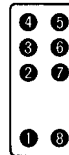

Mounting Holes

Eight, 1.3-dia. holes

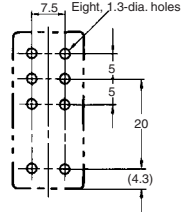



**P2R-05A (1-pole)**

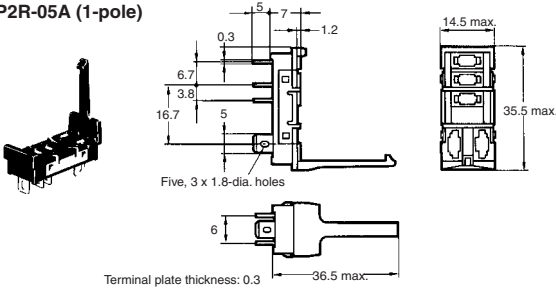

**Terminal Arrangement (Bottom View)**

**Panel Cutout**

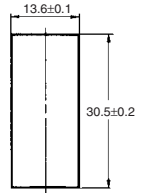

Recommended thickness of the panel is 1.6 to 2.0 mm

**P2R-08A (2-pole)**

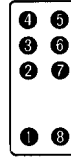
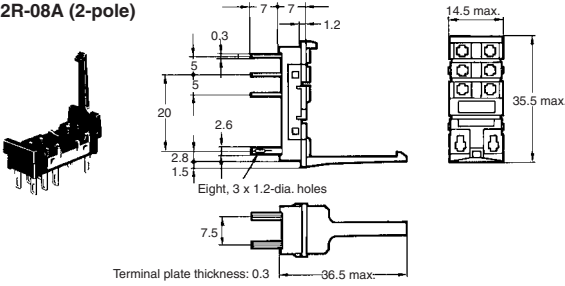

**P2R-057P**

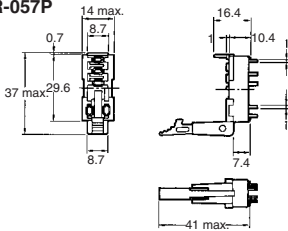

**Terminal Arrangement (Bottom View)**

**Mounting Holes**

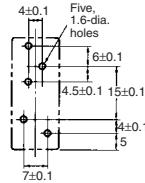

**P2R-087P**

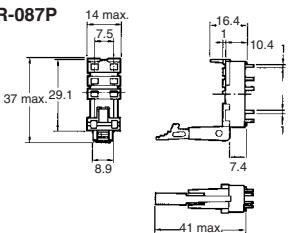

**Terminal Arrangement (Bottom View)**

**Mounting Holes**

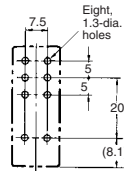

**Mounting Height of Relay with Back-connecting Sockets**

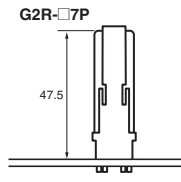
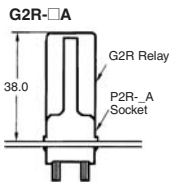
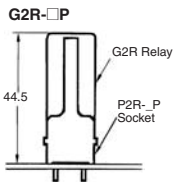

## Mounting Tracks

PFP-100N, PFP-50N

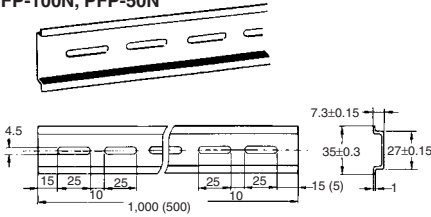

PFP-100N2

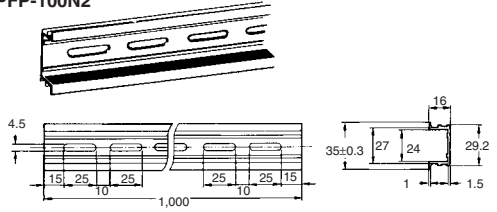

It is recommended to use a panel 1.6 to 2.0 mm thick.

## End Plate

PFP-M

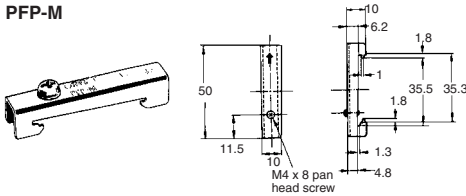

PFP-S

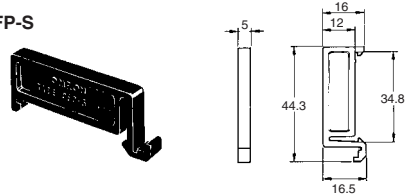

## Precautions

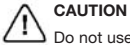

**CAUTION**

Do not use the test button for any purpose other than testing. Be sure not to touch the test button accidentally as this will turn the contacts ON. Before using the test button, confirm that circuits, the load, and any other connected item will operate safely.

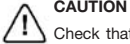

**CAUTION**

Check that the test button is released before turning ON relay circuits.

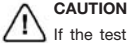

**CAUTION**

If the test button is pulled out too forcefully, it may bypass the momentary testing position and go straight into the locked position.



**CAUTION**

Use an insulated tool when you operate the test button.

### PRECAUTIONS FOR P2RF-□-S CONNECTION

- Do not move the screwdriver up, down, or from side to side while it is inserted in the hole. Doing so may cause damage to internal components (e.g., deformation of the clamp spring or cracks in the housing) or cause deterioration of insulation.
- Do not insert the screwdriver at an angle. Doing so may break the side of the socket and result in a short-circuit.