





A Miniature Power Relay

- Equipped with arc barrier.
- Dielectric strength: 2,000 V.
- Built-in diode models added to the LY Series.
- Single-pole and double-pole models are applicable to operating coils with ratings of 100/110 VAC, 110/120 VAC, 200/220 VAC, 220/240 VAC, or 100/110 VDC).
- Three-pole and four-pole models are applicable to operating coils with ratings of 100/110 VAC, 200/220 VAC, or 100/110 VDC).



Ordering Information

■ Open Relays

Type	Contact form	Plug-in/solder terminals 	Plug-in/solder terminals with LED indicator 	PCB terminals 	Upper-mounting plug-in/solder terminals 
Standard	SPDT	LY1	LY1N	LY1-0	LY1F
	DPDT	LY2	LY2N	LY2-0	LY2F
	DPDT (bifurcated)	LY2Z	LY2ZN	LY2Z-0	LY2ZF
	3PDT	LY3	LY3N	LY3-0	LY3F
	4PDT	LY4	LY4N	LY4-0	LY4F
With built-in diode (DC only)	SPDT	LY1-D	LY1N-D2	–	–
	DPDT	LY2-D	LY2N-D2	–	–
	DPDT (bifurcated)	LY2Z-D	LY2ZN-D2	–	–
	3PDT	LY3-D	–	–	–
	4PDT	LY4-D	LY4N-D2	–	–
With built-in CR (AC only)	SPDT	–	–	–	–
	DPDT	LY2-CR	LY2N-CR	–	–
	DPDT (bifurcated)	LY2Z-CR	LY2ZN-CR	–	–

Note: 1. When ordering, add the rated coil voltage to the model number. Rated coil voltages are given in the coil ratings table.

Example: LY2, 6 VAC

_____ Rated coil voltage

2. Relays with #187 quick connect terminals are also available with SPDT and DPDT contact. Ask your OMRON representative for details.
3. SEV models are standard Relays excluding DPDT (bifurcated) models.
4. VDE- or LR- qualifying Relays must be specified when ordering.

■ Accessories (Order Separately)

Sockets

Poles	Front-connecting Socket	Back-connecting Socket		
	DIN track/screw terminals	Plug-in/solder terminals	Wrapping terminals	PCB terminals
1 or 2	PTF08A-E, PTF08A	PT08	PT08QN	PT08-0
3	PTF11A	PT11	PT11QN	PT11-0
4	PTF14A-E, PTF14A	PT14	PT14QN	PT14-0

Note: 1. For PTF08-E and PTF14A-E, see "Track Mounted Socket."

2. PTF□A (-E) Sockets have met UL and CSA standards: UL 508/CSA C22.2.

Mounting Plates for Sockets

Socket model	For 1 Socket	For 10 Sockets	For 12 Sockets	For 18 Sockets
PT08 PT08QN	PYP-1	-	-	PYP-18
PT11 PT11QN	PTP-1-3	-	PTP-12	-
PT14 PT14QN	PTP-1	PTP-10	-	-

Socket-Hold-down Clip Pairings

Relay type	Poles	Front-connecting Sockets		Back-connecting Sockets	
		Socket model	Clip model	Socket model	Clip model
Standard, bifurcated contacts operation indicator, built-in diode	1, 2	PTF08A-E, PTF08A	PYC-A1	PT08(QN), PT08-0	PYC-P
	3	PTF11A		PT11(QN), PT11-0	
	4	PTF14A-E, PTF14A		PT14(QN), PT14-0	
CR Circuit	2	PTF08A-E, PTF08A	Y92H-3	PT08(QN), PT08-0	PYC-1

Specifications

■ Coil Rating

Single- and Double-pole Relays

	Rated voltage	Rated current		Coil Resistance	Coil Induction (reference value)		Must operate voltage	Must release voltage	Max. voltage	Power consumption (approx.)
		50 Hz	60 Hz		Arm. OFF	Arm. ON				
AC	6 V	214.1 mA	183 mA	12.2 Ω	0.04 H	0.08 H	80% max.	30% min.	110%	1.0 to 1.2 VA (60 Hz)
	12 V	106.5 mA	91 mA	46 Ω	0.17 H	0.33 H				
	24 V	53.8 mA	46 mA	180Ω	0.69 H	1.30 H				
	50 V	25.7 mA	22 mA	788ΩW	3.22 H	5.66 H				
	100/110 V	11.7/12.9mA	10/11 mA	3,750 Ω	14.54 H	24.6 H				
	110/120 V	9.9/10.8 mA	8.4/9.2 mA	4,430 Ω	19.20 H	32.1 H				
	200/220 V	6.2/6.8 mA	5.3/5.8 mA	12,950 Ω	54.75 H	94.07 H				
220/240 V	4.8/5.3 mA	4.2/4.6 mA	18,790 Ω	83.50 H	136.40 H	0.9 to 1 VA (60 Hz)				
DC	6 V	150 mA		40 Ω	0.16 H	0.33 H	10% min.			0.9 W
	12 V	75 mA		160 Ω	0.73 H	1.37 H				
	24 V	36.9 mA		650 Ω	3.20 H	5.72 H				
	48 V	18.5 mA		2,600 Ω	10.6 H	21.0 H				
	100/110 V	9.1/10 mA		11,000 Ω	45.6 H	86.2 H				

Note: See notes on the bottom of next page.

Three-pole Relays

	Rated voltage	Rated current		Coil Resistance	Coil Induction (reference value)		Must operate voltage	Must release voltage	Max. voltage	Power consumption (approx.)
		50 Hz	60 Hz		Arm. OFF	Arm. ON				
AC	6 V	310 mA	270 mA	6.7 Ω	0.03 H	0.05 H	80% max.	30% min.	110%	1.6 to 2.0 VA (60 Hz)
	12 V	159 mA	134 mA	24 Ω	0.12 H	0.21 H				
	24 V	80 mA	67 mA	100 Ω	0.44 H	0.79 H				
	50 V	38 mA	33 mA	410 Ω	2.24 H	3.87 H				
	100/110 V	14.1/16 mA	12.4/13.7 mA	2,300 Ω	10.5 H	18.5 H				
	200/220 V	9.0/10.0 mA	7.7/8.5 mA	8,650 Ω	34.8 H	59.5 H				
DC	6 V	234 mA		25.7 Ω	0.11 H	0.21 H	80% max.	10% min.	110%	1.4 W
	12 V	112 mA		107 Ω	0.45 H	0.98 H				
	24 V	58.6 mA		410 Ω	1.89 H	3.87 H				
	48 V	28.2 mA		1,700 Ω	8.53 H	13.9 H				
	100/110 V	12.7/13 mA		8,500 Ω	29.6 H	54.3 H				

Note: See notes under next table.

Four-pole Relays

	Rated voltage	Rated current		Coil Resistance	Coil Induction (reference value)		Must operate voltage	Must release voltage	Max. voltage	Power consumption (approx.)
		50 Hz	60 Hz		Arm. OFF	Arm. ON				
AC	6 V	386 mA	330 mA	5 Ω	0.02 H	0.04 H	80% max.	30% min.	110%	1.95 to 2.5 VA (60 Hz)
	12 V	199 mA	170 mA	20 Ω	0.10 H	0.17 H				
	24 V	93.6 mA	80 mA	78 Ω	0.38 H	0.67 H				
	50 V	46.8 mA	40 mA	350 Ω	1.74 H	2.88 H				
	100/110 V	22.5/25.5 mA	19/21.8 mA	1,600 Ω	10.5 H	17.3 H				
	200/220 V	11.5/13.1 mA	9.8/11.2 mA	6,700 Ω	33.1 H	57.9 H				
DC	6 V	240 mA		25 Ω	0.09 H	0.21 H	80% max.	10% min.	110%	1.5 W
	12 V	120 mA		100 Ω	0.39 H	0.84 H				
	24 V	69 mA		350 Ω	1.41 H	2.91 H				
	48 V	30 mA		1,600 Ω	6.39 H	13.6 H				
	100/110 V	15/15.9 mA		6,900 Ω	32 H	63.7 H				

Note: 1. The rated current and coil resistance are measured at a coil temperature of 23°C with tolerances of +15%/–20% for rated currents and ±15% for DC coil resistance.

2. Performance characteristic data are measured at a coil temperature of 23°C.

3. AC coil resistance and impedance are provided as reference values (at 60 Hz).

4. Power consumption drop was measured for the above data. When driving transistors, check leakage current and connect a bleeder resistor if required.

■ Contact Rating

Relay	Single Contact				Bifurcated contacts	
	1-pole		2-, 3- or 4-pole		2-pole	
Load	Resistive load ($\cos\phi = 1$)	Inductive load ($\cos\phi = 0.4$, L/R = 7 ms)	Resistive load ($\cos\phi = 1$)	Inductive load ($\cos\phi = 0.4$, L/R = 7 ms)	Resistive load ($\cos\phi = 1$)	Inductive load ($\cos\phi = 0.4$, L/R = 7 ms)
Rated Load	110 VAC 15 A 24 VDC 15 A	110 VAC 10 A 24 VDC 7 A	110 VAC 10 A 24 VDC 10 A	110 VAC 7.5 A 24 VDC 5 A	110 VAC 5A 24 VDC 5 A	110 VAC 4 A 24 VDC 4A
Rated Carry Current	15 A		10 A		7 A	
Max. switching voltage	250 VAC 125 VDC		250 VAC 125 VDC		250 VAC 125 VDC	
Max. switching current	15 A		10 A		7 A	
Max. switching power	1,700 VA 360 W	1,100 VA 170 W	1,100 VA 240 W	825 VA 120 W	550 VA 120 W	440 VA 100 W
Failure rate (reference value)*	100 mA, 5 VDC		100 mA, 5 VDC		100 mA, 5 VDC	

*Note: P level: $\lambda_{60} = 0.1 \times 10^{-6}/\text{operation}$

■ Characteristics

Item	All except Relays with bifurcated contacts	Relays with bifurcated contacts
Contact resistance	50 mΩ max.	
Operate time	25 ms max.	
Release time	25 ms max.	
Max. operating frequency	Mechanical: 18,000 operations/hr Electrical: 1,800 operations/hr (under rated load)	
Insulation resistance	100 MΩ min. (at 500 VDC)	
Dielectric strength	1,000 VAC, 50/60 Hz for 1 min between contacts of same polarity 2,000 VAC, 50/60 Hz for 1 min between contacts of different polarity	
Vibration resistance	Destruction: 10 to 55 to 10 Hz, 0.5 mm single amplitude (1.0 mm double amplitude) Malfunction: 10 to 55 to 10 Hz, 0.5 mm single amplitude (1.0 mm double amplitude)	
Shock resistance	Destruction: 1,000 m/s ² Malfunction: 200 m/s ²	
Endurance	Mechanical: AC: 50,000,000 operations min. (at 18,000 operations/hr) DC: 1,00,000,000 operations min. (at 18,000 operations/hr) Electrical: Single-, three-, and four-pole: 200,000 operations min. (at 1,800 operations/hr under rated load) Double-pole: 500,000 operations min. (at 1,800 operations/hr under rated load)	
Ambient temperature*	Operating: Single- and double-pole standard, bifurcated-contact Relays: -25°C to 55°C (with no icing) (-25°C to 70°C if carry current is 4 A or less) All other Relays: -25°C to 40°C (with no icing) (-25°C to 55°C if carry current is 4 A or less)	
Ambient humidity	Operating: 5% to 85%	
Weight	Single- and double-pole: approx. 40 g, three-pole: approx. 50 g, four-pole: approx. 70 g	

Note: 1. The values given above are initial values

2. The upper limit of 40°C for some Relays is because of the relationship between diode junction temperature and the element used.

■ Endurance Under Real Loads (reference only)

LY1

Rated voltage	Load type	Conditions	Operating frequency	Electrical life
100 VAC	AC motor	400 W, 100 VAC single-phase with 35-A inrush current, 7-A current flow	ON for 10 s, OFF for 50 s	50,000 operations
		300 W, 100 VAC with 51-A inrush current, 3-A current flow		100,000 operations
	AC lamp	500 W, 100 VAC with 78-A inrush current, 5-A current flow	ON for 5 s, OFF for 55 s	25,000 operations
		24 VDC with 50-A inrush current, 1-A current flow		100,000 operations
	Capacitor (2,000 μF)	24 VDC with 50-A inrush current, 1-A current flow	ON for 1 s, OFF for 6 s	100,000 operations
	AC solenoid	50 VA with 2.5-A inrush current, 0.25-A current flow	ON for 1 s, OFF for 2 s	1,500,000 operations
100 VA with 5-A inrush current, 0.5-A current flow		800,000 operations		

LY2

Rated voltage	Load type	Conditions	Operating frequency	Electrical life
100 VAC	AC motor	200 W, 100 VAC single-phase with 25-A inrush current, 5-A current flow	ON for 10 s, OFF for 50 s	200,000 operations
		300 W, 100 VAC with 51-A inrush current, 3-A current flow		80,000 operations
	Capacitor (2,000 μF)	24 VDC with 50-A inrush current, 1-A current flow	ON for 1 s, OFF for 15 s	10,000 operations
		24 VDC with 20-A inrush current, 1-A current flow		150,000 operations
	AC solenoid	50 VA with 2.5-A inrush current, 0.25-A current flow	ON for 1 s, OFF for 2 s	1,000,000 operations
		100 VA with 5-A inrush current, 0.5-A current flow		500,000 operations

LY4

Rated voltage	Load type	Conditions	Operating frequency	Electrical life
100 VAC	AC motor	200 W, 200 VAC triple-phase with 5-A inrush current, 1-A current flow	ON for 10 s, OFF for 50 s	500,000 operations
		750 W, 200 VAC triple-phase with 18-A inrush current, 3.5 A current flow		70,000 operations
	AC lamp	300 W, 100 VAC with 51-A inrush current, 3-A current flow	ON for 5 s, OFF for 55 s	50,000 operations
	Capacitor (2,000 μF)	24 VDC with 50-A inrush current, 1-A current flow	ON for 1 s, OFF for 15 s	5,000 operations
		24 VDC with 20-A inrush current, 1-A current flow	ON for 1 s, OFF for 2 s	200,000 operations
	AC solenoid	50 VA with 2.5-A inrush current, 0.25-A current flow	ON for 1 s, OFF for 2 s	1,000,000 operations
100 VA with 5-A inrush current, 0.5-A current flow		500,000 operations		

■ Approved Standards

UL 508 Recognitions (File No. 41643)

No. of poles	Coil ratings	Contact ratings	Operations
1	6 to 240 VAC 6 to 125 VDC	15 A, 30 VDC (Resistive)	6 x 10 ³
		15 A, 240 VAC (General use) TV-5, 120 VAC 1/2 HP, 120 VAC	25 x 10 ³
2		15 A, 28 VDC (Resistive)	6 x 10 ³
		15 A, 120 VAC (Resistive) 12 A, 240 VAC (General use) 1/2 HP, 120 VAC TV-3, 120 VAC	25 x 10 ³
3 and 4		10 A, 30 VDC (Resistive) 10 A, 240 VAC (General use) 1/3 HP, 240 VAC	6 x 10 ³

CSA 22.2 No. 14 Listings (File No. LR31928)

No. of poles	Coil ratings	Contact ratings	Operations
1	6 to 240 VAC 6 to 125 VDC	15 A, 30 VDC (Resistive)	6 x 10 ³
		15 A, 120 VAC (General use) 1/2 HP, 120 VAC TV-5, 120 VAC	25 x 10 ³
2		15 A, 30 VDC (Resistive)	6 x 10 ³
		15 A, 120 VAC (Resistive) 1/2 HP, 120 VAC TV-3, 120 VAC	
3 and 4		10 A, 30 VDC (Resistive) 10 A, 240 VAC (General use)	

SEV Listings (File No. D3,31/137)

No. of poles	Coil ratings	Contact ratings	Operations
1	6 to 240 VAC 6 to 125 VDC	15 A, 24 VDC 15 A, 220 VAC	6 x 10 ³
2 to 4		10 A, 24 VDC 10 A, 220 VAC	

TÜV (File No. R9251226) (IEC255)

No. of poles	Coil ratings	Contact ratings	Operations
1 to 4	6 to 125 VDC 6 to 240 VAC	LY1, LY1-FD 15 A, 110 VAC (cosφ = 1) 10 A, 110 VAC (cosφ = 0.4) LY2, LY2-FD, LY3, LY3-FD, LY4, LY4-FD 10 A, 110 VAC (cosφ = 1) 7.5 A, 110 VAC (cosφ = 0.4)	100 x 10 ³

VDE Recognitions (No. 9903UG and 9947UG)

No. of poles	Coil ratings	Contact ratings	Operations
1	6, 12, 24, 50, 110, 220 VAC 6, 12, 24, 48, 110 VDC	10 A, 220 VAC (cosφ = 1) 7 A, 220 VAC (cosφ = 0.4) 10 A, 28 VDC (L/R = 0 ms) 7 A, 28 VDC (L/R = 7 ms)	200 x 10 ³
2		7 A, 220 VAC (cosφ = 1) 4 A, 220 VAC (cosφ = 0.4) 7 A, 28 VDC (L/R = 0 ms) 4 A, 28 VDC (L/R = 7 ms)	

■ Approved Standards (cont.)
 LR Recognitions (No. 563KOB-204523)

No. of poles	Coil ratings	Contact ratings
2, 4	6 to 240 VAC 6 to 110 VDC	7.5 A, 230 VAC (PF0.4) 5 A, 24 VDC (L/R=7 ms)

Engineering Data

LY1
 Maximum Switching Power

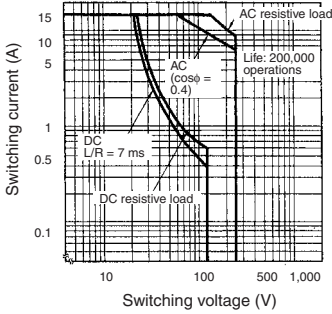

Endurance

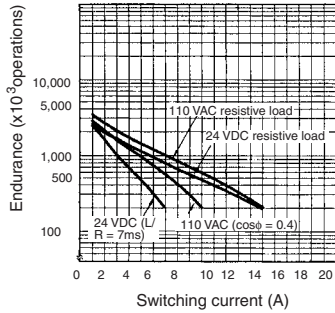

LY2
 Maximum Switching Power

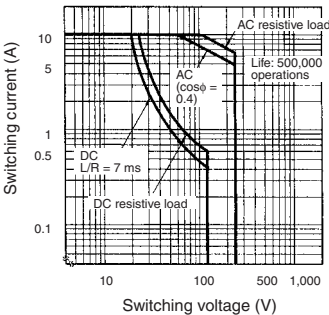

Endurance

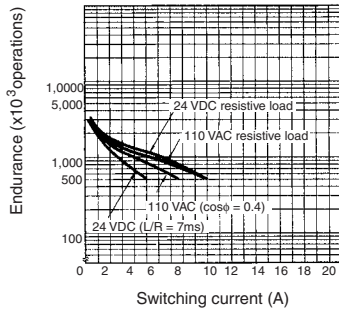

LY3 and LY4
 Maximum Switching Power

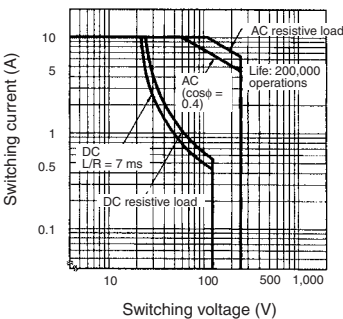

Endurance

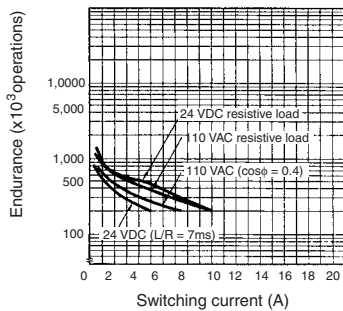

LY2Z
Maximum Switching Power

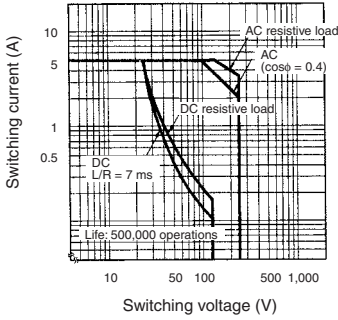

LY2Z
Endurance

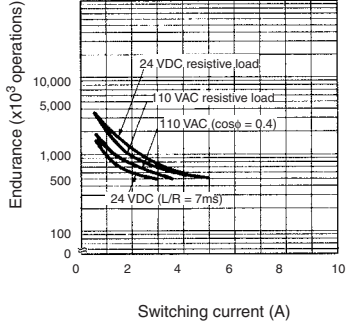

Dimensions

Note: All units are in millimetres unless otherwise indicated.

■ Relays with Solder/Plug-in Terminals

LY1
LY1N (-D2)
LY1-D

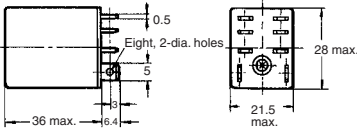
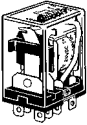

Terminal Arrangement/Internal Connections (Bottom View)

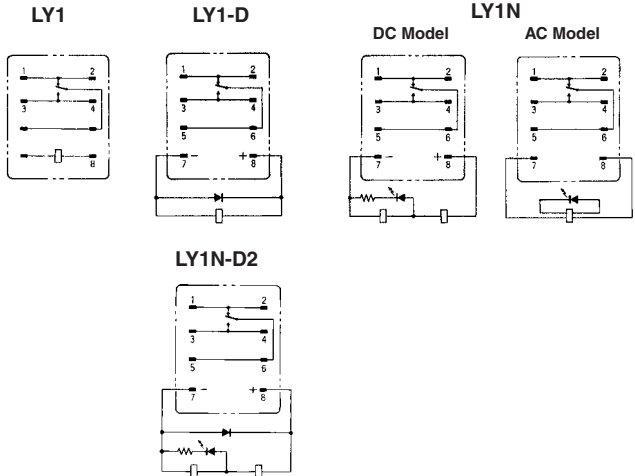

Note: The DC models have polarity.

LY2 LY2Z
 LY2-D LY2Z-D
 LY2N LY2ZN
 LY2N-D2 LY2ZN-D2

Terminal Arrangement/Internal Connections (Bottom View)

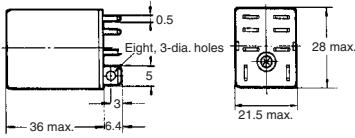
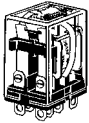

LY2(Z)

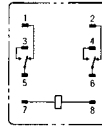

LY2(Z)-D

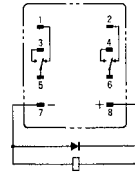

DC Model LY2(Z)N

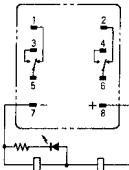

AC Model

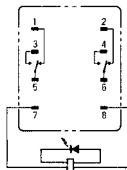

LY2(Z)N-D2

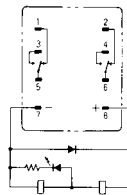

Note: The DC models have polarity.

LY3
 LY3N
 LY3-D

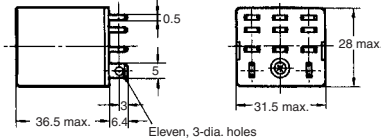
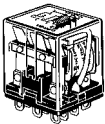

Terminal Arrangement/Internal Connections (Bottom View)

LY3

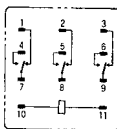

LY3-D

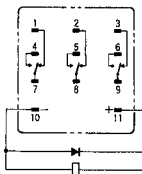

DC Model

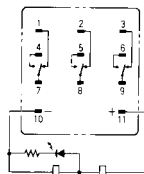

LY3N

AC Model

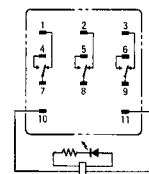

Note: The DC models have polarity.

■ Upper Mounting relays

LY1F
LY2F

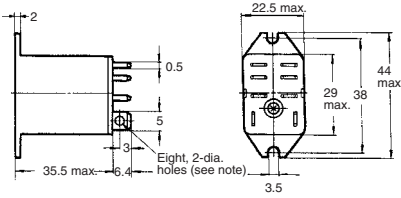
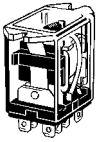

Mounting Holes

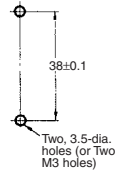

Note: 1. Eight 3-dia. holes should apply to the LY2F model.

LY3F

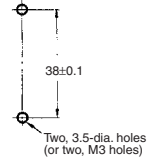
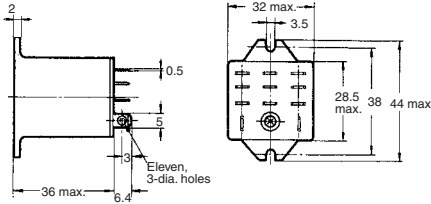
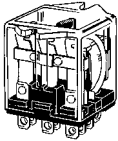

LY4F

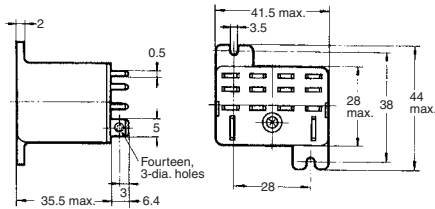
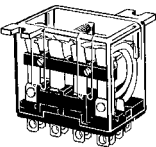

Mounting holes

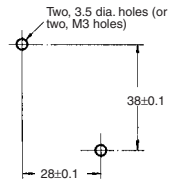

■ Mounting Height with Socket

The following Socket heights should be maintained.

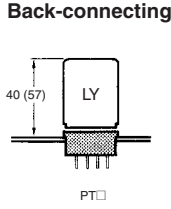
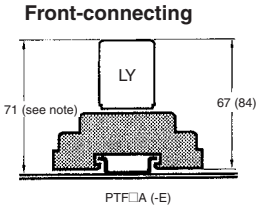

Note: 1. The PTF□A (-E) can be track-mounted or screw-mounted.
2. For the LY□-CR (CR circuit built-in type) model, this figure should be 88.

■ Sockets

PTF08A-E

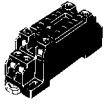

PTF11A

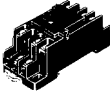

PTF14A-E

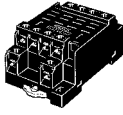

PT08



PT11



PT14

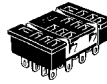

PT08QN



PT11QN



PT14QN



PT08-0



PT11-0



PT14-0



Mounting Plates for Back-connecting

PYP-1

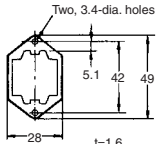

PTP-1-3

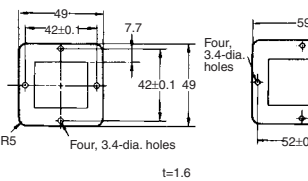

PTP-1

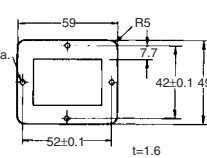

PYP-18

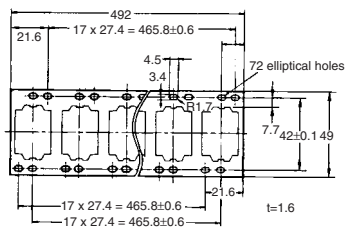

PTP-10

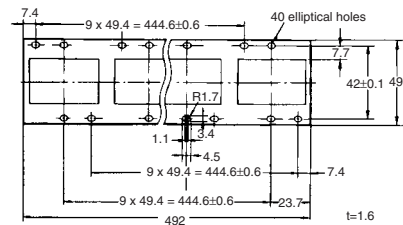



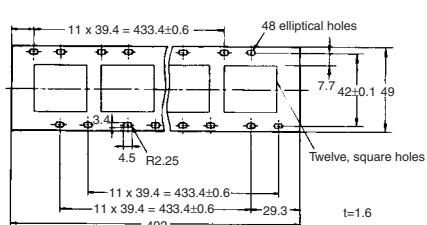

PTP-12

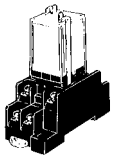

■ Hold-down Clips

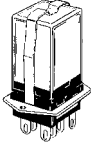
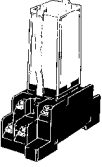
Hold-down clips are used to hold Relays to Sockets and prevent them from coming loose due to vibration or shock.

Used with Socket		Used with Socket mounting plate	For CR circuit built-in Relay	
<p>PYC-A1</p> 	<p>PYC-P</p> 	<p>PYC-S</p> 	<p>Y92H-3</p> 	<p>PYC-1</p> 

Precautions

■ Connections

Do not reverse polarity when connecting DC-operated Relays with built-in diodes or indicators.

ALL DIMENSIONS SHOWN ARE IN MILLIMETRES.

To convert millimetres into inches, multiply by 0.03937. To convert grams into ounces, multiply by 0.03527.