

13 12 11 10 9 8 7 6 5 4 3 2 1

J  
I  
H  
G  
F  
E  
D  
C  
B  
A

J  
I  
H  
G  
F  
E  
D  
C  
B  
A

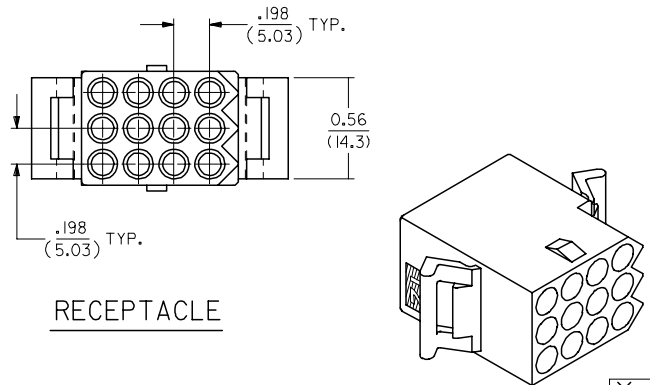
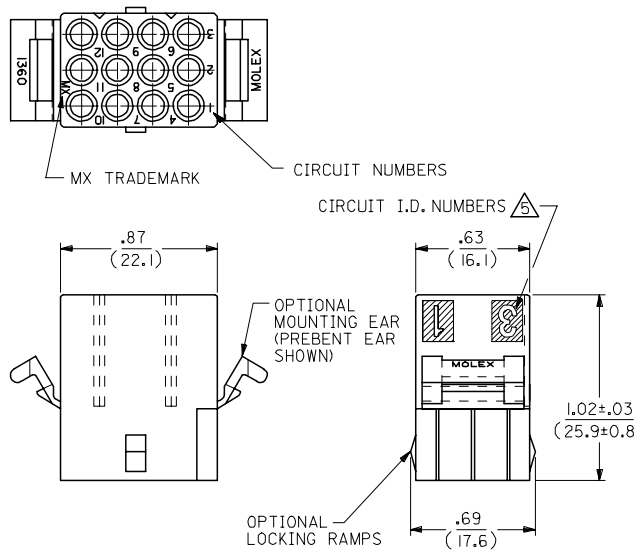

RECEPTACLE

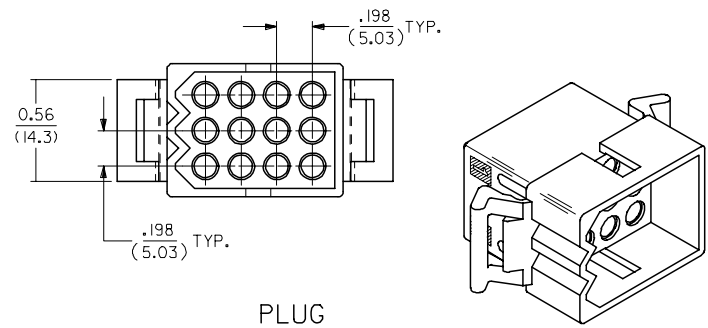
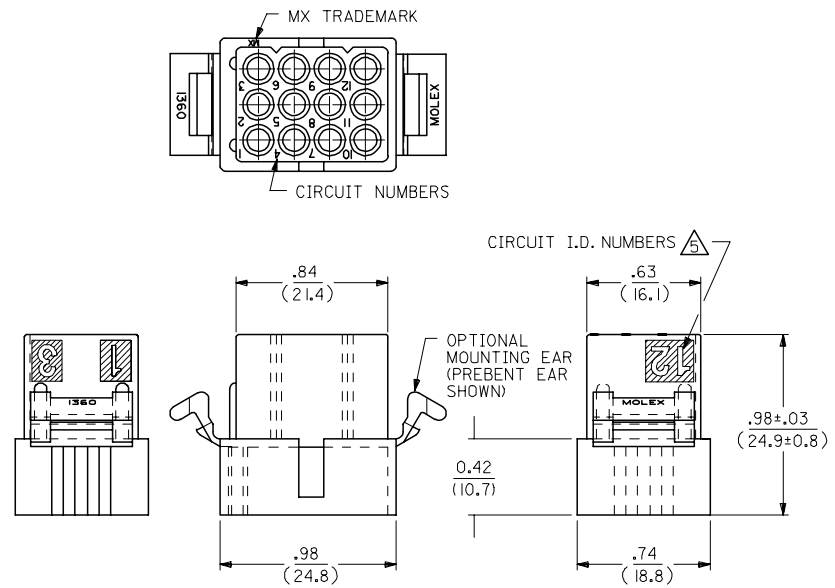

PLUG

UPDATE TITLE BLOCK EC. NO. UCP2006-0080 DRAWN: JLOME CHKD: 2005/07/20 APPR: FSM TH 2005/07/21 REV. DESCRIPTION	QUALITY SYMBOLS	GENERAL TOLERANCES (UNLESS SPECIFIED)	DIMENSION STYLE	SCALE	DESIGN UNITS	THIRD ANGLE PROJECTION
	$\nabla=0$ $\nabla=0$	mm INCH 4 PLACES ± --- ± --- 3 PLACES ± --- ± .010 2 PLACES ± 0.25 ± .014 1 PLACE ± 0.35 ± --- ANGULAR ± 2 °	IN/MM DRAWN BY DATE KBW 3/1/89 CHECKED BY DATE RW 3/1/89 APPROVED BY DATE RAS 3/1/89 MATERIAL NO. DOCUMENT NO.	2:1	INCH	
	DRAFT WHERE APPLICABLE MUST REMAIN WITHIN DIMENSIONS	SEE CHART SIZE C	.093/(2.36) HOUSINGS PLUG AND RECEPTACLE 12 CKT, .198/(5.03)CTR. MOLEX INCORPORATED	SHEET NO. 1 OF 2		
	AE1					

2	AE1
1	AE1
SHT/REV	

12 11 10 9 8 7 6 5 4 3 2 1

PLUG		
ORDER NO	ENG NO	
03-09-2121	I360-P	
03-09-2122 $\triangle$	I360-P1	
03-09-7121	I360-PBK	
03-09-7122 $\triangle$	I360-P1BK	OBSOLETE

RECEPTACLE	
ORDER NO	ENG NO
03-09-1121	I360-R
03-09-1122	I360-R1
03-09-1125	I360-R2
03-09-1126	I360-R3
03-09-6121	I360-RBK
03-09-6122	I360-R1BK
03-09-6125	I360-R2BK
03-09-6126	I360-R3BK
03-09-6123	I360-R1RD
03-09-6124	I360-R1YW

**LEGEND: PLUG**

I360-P\*\*\*

P = PLUG

BLANK = WITHOUT EARS

I = WITH MOUNTING EARS

COLOR:

BLANK = NATURAL COLOR

AM = AMBER BK = BLACK BU = BLUE

BN = BROWN GY = GRAY GN = GREEN

OR = ORANGE RD = RED YW = YELLOW

**LEGEND: RECEPTACLE**

I360-R\*\*\*

R = RECEPTACLE

BLANK = WITH PREBENT EARS ONLY

1 = WITHOUT EARS/WITHOUT LOCKING RAMP

2 = WITH PREBENT EARS & LOCKING RAMP

3 = WITH LOCKING RAMP ONLY

COLOR:

BLANK = NATURAL COLOR

AM = AMBER BK = BLACK BU = BLUE

BN = BROWN GY = GRAY GN = GREEN

OR = ORANGE RD = RED YW = YELLOW

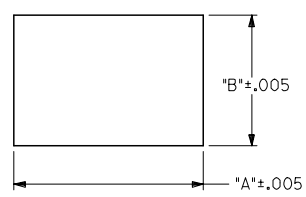
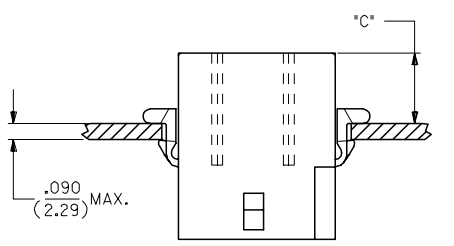

RECOMMENDED PANEL OPENING

HOUSING	DIM. 'A'	DIM. 'B'	'C' PREBENT EAR	'C' STANDARD EAR
PLUG	1.155/(29.34)	.760/(19.30)	.40/(10.2)	.36/(9.1)
RECEPT.	1.050/(26.67)	.725/(18.42)	.41/(10.4)	.37/(9.4)

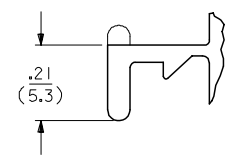

**DETAIL A**  
.093/(2.36) STANDARD MOUNTING EAR  
(SCALE 4:1)

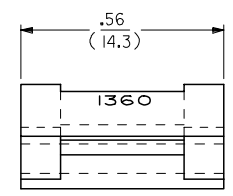

**DETAIL B**  
.093/(2.36)PREBENT MOUNTING EAR  
(SCALE 4:1)

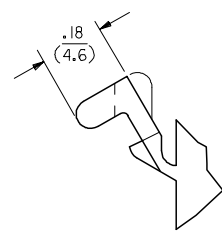

NOTES:

1. MATERIAL: NYLON TYPE 6/6, UL94V-2
  2. FINISH: N/A
  3. PRODUCT SPECIFICATION: PS-02-09, PS-43660-9999
  4. PACKAGING SPECIFICATION: PK-1360-001
- $\triangle$  CIRCUIT I.D. NUMBERS ON SIDE OF HOUSING APPEAR ON PARTS FROM TOOLS BUILT AFTER 10/22/91
- $\triangle$  WHERE DENOTED IN CHART, TOOLS ARE BUILT WITH PREBENT MOUNTING EARS PER DETAIL B AND SUPERSEDE ALL TOOLS PREVIOUSLY BUILT WITH THE STANDARD EARS.

UPDATE TITLE BLOCK EC NO: UCP2006-0080 DRAWN: JLOME CHKD: 2005/07/20 APPR: FSM TH 2005/07/21	QUALITY SYMBOLS ▽=0 ▽=0	GENERAL TOLERANCES (UNLESS SPECIFIED)		DIMENSION STYLE		SCALE	DESIGN UNITS	THIRD ANGLE PROJECTION	
				IN/MM		2:1	INCH		
		4 PLACES ± .010	± .010	DRAWN BY	DATE	TITLE			
		3 PLACES ± .014	± .014	KBW	3/1/89	.093/(2.36) HOUSINGS PLUG AND RECEPTACLE 12 CKT, .198/(5.03)CTR.			
2 PLACES ± 0.25	± .014	RW	3/1/89	CHECKED BY		DATE			
1 PLACE ± 0.35	± .014	RAS	3/1/89	APPROVED BY		DATE			
ANGULAR ± 2 °		MATERIAL NO.		DOCUMENT NO.		SHEET NO.			
DRAFT WHERE APPLICABLE MUST REMAIN WITHIN DIMENSIONS		SEE CHART		SD-1360-*		2 OF 2			
THIS DRAWING CONTAINS INFORMATION THAT IS PROPRIETARY TO MOLEX INCORPORATED AND SHOULD NOT BE USED WITHOUT WRITTEN PERMISSION									