

# Miniature Push-Pull Circular Connectors

## HR25A Series

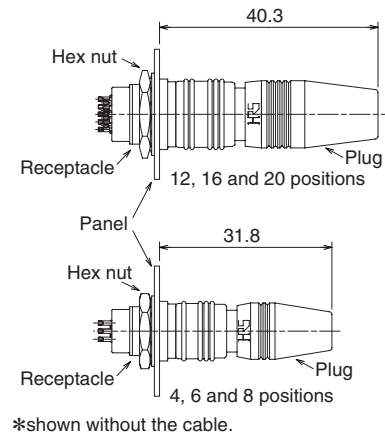

### Mated dimensions



### Connecting combinations

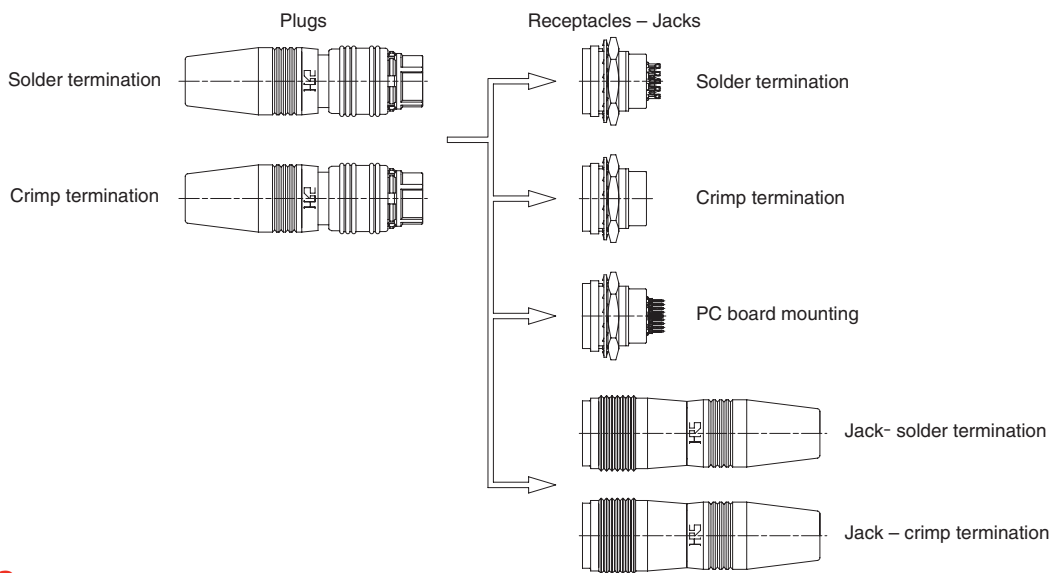

### Features

#### 1. Small size – high density

Outside diameters - plugs (max): 11 mm : 4,6 and 8 positions  
 13 mm : 12,16 and 20 positions

#### 2. Simple push-in/ pull-out mating / un-mating

Polarized for correct insertion by a straight push-in movement.  
 Built-in lock release mechanism securely locks mated connectors while allowing quick disconnection by simply pulling on the plug release collar.

#### 3. Several mounting number of positions, styles and terminations

Number of positions : 4, 6, 8, 12, 16 and 20  
 Connectors : Plugs, jacks, receptacles  
 Terminations : Solder, crimp or PC board through-hole (receptacles only)  
 Choice of socket or pin contacts for plugs and receptacles.

#### 4. Metal shells

Secure lock between the metal shells provides excellent ground connection required in applications requiring EMI protection.

### Applications

CCD cameras, measuring instruments, entertainment centers, medical equipment and other applications requiring use of reliable small circular connectors.

**HR25A Series • Miniature Push-Pull Circular Connectors**

**Specifications**

Ratings	Current rating	1 A	Operating temperature range	-25°C to +85°C
	Voltage rating	30 V AC, 42 V DC	Storage temperature range	-25°C to +85°C (Note 1)

Item	Specification	Conditions
1. Insulation resistance	1,000 MΩ min.	100 V DC
2. Withstanding voltage	No flashover or insulation breakdown	100 V AC / one minute (test voltage)
3. Contact resistance	30 mΩ max.	1 A DC
4. Durability	Contact resistance: 50 mΩ max.	No damage, cracks or parts dislocation 1,000 cycles
5. Vibration	No electrical discontinuity of 10 μs or longer No damage, cracks or parts dislocation.	Frequency: 10 to 55 Hz, single amplitude of 0.75 mm 5 minute cycle, 10 cycles in each of the 3 axis
6. Humidity	Insulation resistance: 5 MΩ min. (at high humidity) Insulation resistance: 50 MΩ min. (when dry) No damage, cracks or parts dislocation.	96 hours at 40°C, and humidity of 90 to 95%
7. Temperature cycle	Insulation resistance: 1,000 MΩ min.	Temperature :-55°C → +15°C to +35°C → +85°C → +15°C to +35°C Time :30min. →2to 3 min. →30min. →2to 3 min. 5 cycles

Note: The term “storage” refers to connectors stored for long period of time prior to termination or mounting.

**Material**

Item	Material	Finish	Remarks
Plugs Jacks	Outer shell	Zinc alloy	Nickel plated
	Insulator	PPS	UL94V-0
	Gasket, boots	Ethylene propylene rubber	
	Contacts	Phosphor bronze	Gold plated
Receptacles	Outer shell	Zinc alloy	Nickel plated
	Insulator	PPS	UL94V-0
	Contacts	Phosphor bronze	Gold plated

**Ordering information**

**HR 25 A - 7 P - 6 S C (※※)**

①
②
③
④
⑤
⑥
⑦

① Series name: HR25A Series	⑤ Contact type: S : Female contacts P : Male contacts
② Shell size: Outside diameter of plug mating portion	⑥ Termination type: Blank : Solder C : Crimp D : DIP
③ Connector type: P : Plug R : Receptacle J : Jack	⑦ Other specifications: 2 numerical digits will be added when there is a specifications change other than shown in positions ① to ⑥.
④ Number of contacts: 4, 6, 8, 12, 16, 20	

## ■ Plugs

### ● Solder termination (contacts inserted)

Shell size: 7

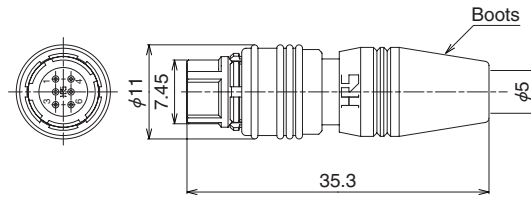

Shell size: 9

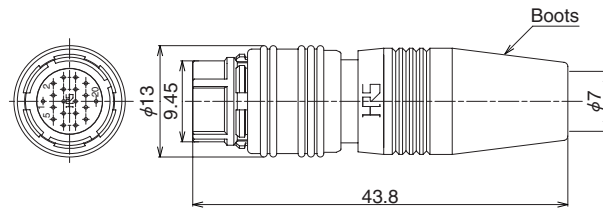

All dimensions: mm

Shell size	Number of contacts	Male contact		Female contact		RoHS
		Part Number	CL No.	Part Number	CL No.	
7	4	HR25A-7P-4P	125-0612-1	HR25A-7P-4S	125-0613-4	YES
	6	HR25A-7P-6P	125-0602-8	HR25A-7P-6S	125-0611-9	
	8	HR25A-7P-8P	125-0609-7	HR25A-7P-8S	125-0610-6	
9	12	HR25A-9P-12P	125-0607-1	HR25A-9P-12S	125-0608-4	
	16	HR25A-9P-16P	125-0605-6	HR25A-9P-16S	125-0606-9	
	20	HR25A-9P-20P	125-0600-2	HR25A-9P-20S	125-0604-3	

### ● Crimp termination (separate contacts required)

Shell size	Number of contacts	Male contact		Female contact		RoHS
		Part Number	CL No.	Part Number	CL No.	
9	12	HR25A-9P-12PC	125-0652-6	HR25A-9P-12SC	125-0653-9	YES
	16	HR25A-9P-16PC	125-0650-0	HR25A-9P-16SC	125-0651-3	
	20	HR25A-9P-20PC	125-0648-9	HR25A-9P-20SC	125-0649-1	

**HR25A Series Miniature Push-Pull Circular Connectors**

**Receptacles**

**Solder termination (contacts inserted)**

Shell size: 7

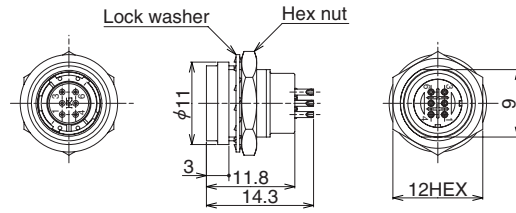

Shell size: 9

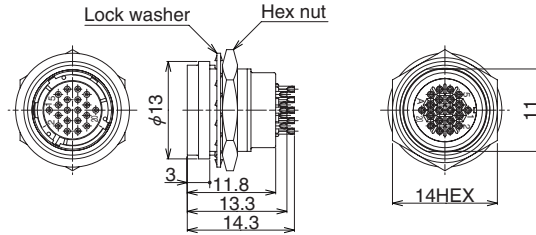

All dimensions: mm

Shell size	Number of contacts	Male contact		Female contact		RoHS
		Part Number	CL No.	Part Number	CL No.	
7	4	HR25A-7R-4P	125-0623-8	HR25A-7R-4S	125-0622-5	YES
	6	HR25A-7R-6P	125-0621-2	HR25A-7R-6S	125-0603-0	
	8	HR25A-7R-8P	125-0620-0	HR25A-7R-8S	125-0619-0	
9	12	HR25A-9R-12P	125-0618-8	HR25A-9R-12S	125-0617-5	
	16	HR25A-9R-16P	125-0616-2	HR25A-9R-16S	125-0615-0	
	20	HR25A-9R-20P	125-0614-7	HR25A-9R-20S	125-0601-5	

**Crimp termination (separate contacts required)**

HR25A-9R-20SC

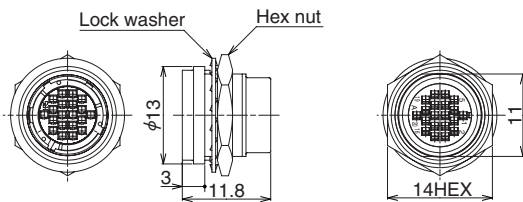

All dimensions: mm

Shell size	Number of contacts	Pin contact		Female contact		RoHS
		Part Number	CL No.	Part Number	CL No.	
9	12	HR25A-9R-12PC	125-0659-5	HR25A-9R-12SC	125-0658-2	YES
	16	HR25A-9R-16PC	125-0657-0	HR25A-9R-16SC	125-0656-7	
	20	HR25A-9R-20PC	125-0654-1	HR25A-9R-20SC	125-0655-4	

## Receptacles

### Through hole (for PC board mounting)

Shell size: 7  
HR25A-7R-6SA

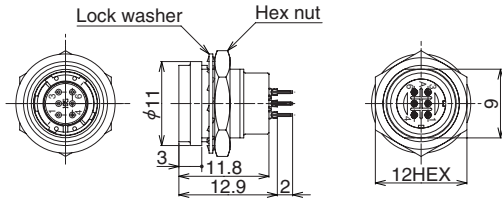

Shell size: 9  
HR25A-9R-20SA

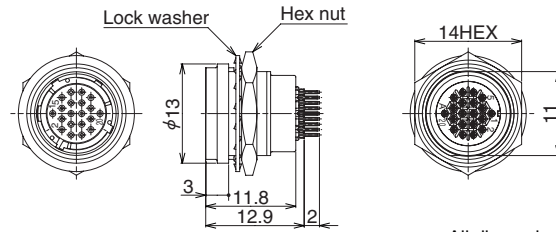

All dimensions: mm

Shell size	Number of contacts	Male contact		Female contact		RoHS
		Part Number	CL No.	Part Number	CL No.	
7	4	HR25A-7R-4PA	125-0647-6	HR25A-7R-4SA	125-0646-3	YES
	6	HR25A-7R-6PA	125-0645-0	HR25A-7R-6SA	125-0644-8	
	8	HR25A-7R-8PA	125-0643-5	HR25A-7R-8SA	125-0642-2	
9	12	HR25A-9R-12PA	125-0641-0	HR25A-9R-12SA	125-0640-7	
	16	HR25A-9R-16PA	125-0639-8	HR25A-9R-16SA	125-0638-5	
	20	HR25A-9R-20PA	125-0637-2	HR25A-9R-20SA	125-0636-0	

## Jacks

### Solder termination (contact inserted)

Shell size: 7  
HR25A-7J-6S

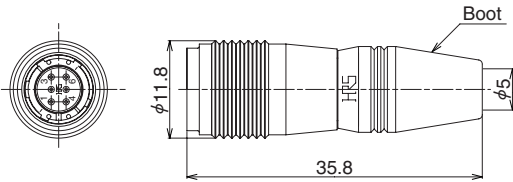

Shell size: 9  
HR25A-9J-20S

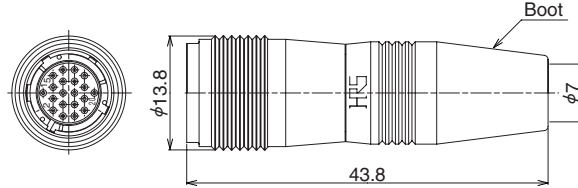

All dimensions: mm

Shell size	Number of contacts	Male contact		Female contact		RoHS
		Part Number	CL No.	Part Number	CL No.	
7	4	HR25A-7J-4P	125-0635-7	HR25A-7J-4S	125-0634-4	YES
	6	HR25A-7J-6P	125-0633-1	HR25A-7J-6S	125-0632-9	
	8	HR25A-7J-8P	125-0631-6	HR25A-7J-8S	125-0630-3	
9	12	HR25A-9J-12P	125-0629-4	HR25A-9J-12S	125-0628-1	
	16	HR25A-9J-16P	125-0627-9	HR25A-9J-16S	125-0626-6	
	20	HR25A-9J-20P	125-0625-3	HR25A-9J-20S	125-0624-0	

### Crimp termination (separate contacts required)

All dimensions: mm

Shell size	Number of contacts	Male contact		Female contact		RoHS
		Part Number	CL No.	Part Number	CL No.	
9	12	HR25A-9J-12PC	125-0665-8	HR25A-9J-12SC	125-0664-5	YES
	16	HR25A-9J-16PC	125-0663-2	HR25A-9J-16SC	125-0662-0	
	20	HR25A-9J-20PC	125-0661-7	HR25A-9J-20SC	125-0660-4	

**HR25A Series • Miniature Push-Pull Circular Connectors**

**■ Crimp contacts**

**Male contact**

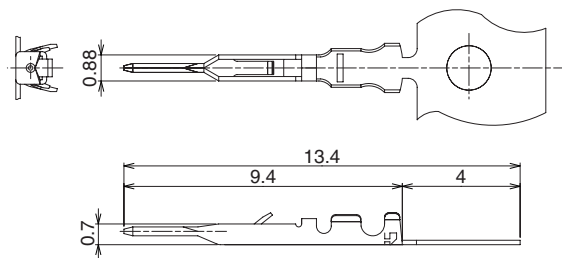

**Female contact**

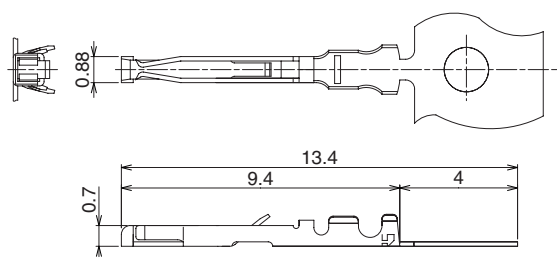

All dimensions: mm

Part Number	CL No.	Packaging	Conductor size / construction	RoHS
HR25-PC-111	125-0419-1	100 pcs. per bag	AWG#30	YES
HR25-PC-211	125-0420-0	10,000 pcs. per reel		

Part Number	CL No.	Packaging	Conductor size / construction	RoHS
HR25-SC-111	125-0421-3	100 pcs. per bag	AWG#30	YES
HR25-SC-211	125-0422-6	10,000 pcs. per reel		

Note: Wire jacket outer diameter 0.71 mm max.

**◆ Applicable tools**

Type	Part Number	CL No.	Used on	
Manual contact crimping tool	HR25-TA3032HC	150-0207-3	HR25-PC-111 or HR25-SC-111	
Automatic crimping machine	CM-105	901-0005-4	—	
Applicator	AP105-HR25-1	901-2040-6	HR25-PC-211 or HR25-SC-211	
Cable clamp crimp tool	HR10A-TC-02	150-0041-2		
Solder termination fixture	HR25A-7P-T02	150-0243-7	HR25A-7P	For tightening
	HR25A-7P-T03	150-0248-0	HR25A-7P	For wiring
Plug shell tightening fixture	HR25A-9P-T02	150-0242-4	HR25A-9P	For tightening
	HR25A-9P-T03	150-0247-8	HR25A-9P	For wiring
Contact extraction tool	HR25-TP	150-0091-0	HR25-PC-111 or HR25-SC-111	
Hex set screw driver	PB205/1.27	150-0066-3		

## ◆ Panel cutouts

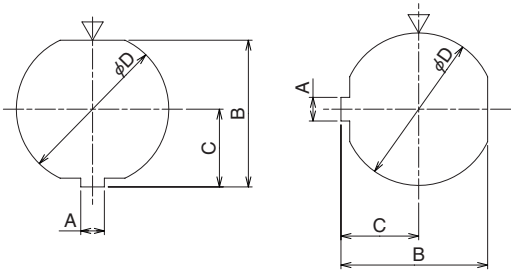

All dimensions: mm

Dimensions	HR25A-7R	HR25A-9R
A	1.55 +0.05/ -0	
B	9.05 +0.03/ -0.02	11.05 +0.03/ -0.02
C	5.1 +0.1/ -0	6.1 +0.1/ -0
D	10 +0.05/ -0	12 +0.05/ -0
Applicable panel thickness	0.7 to 2	

Notes 1: The receptacle panel cutout is a view from the mating side.

## ◆ PCB mounting pattern (for through-hole PC board mounting)

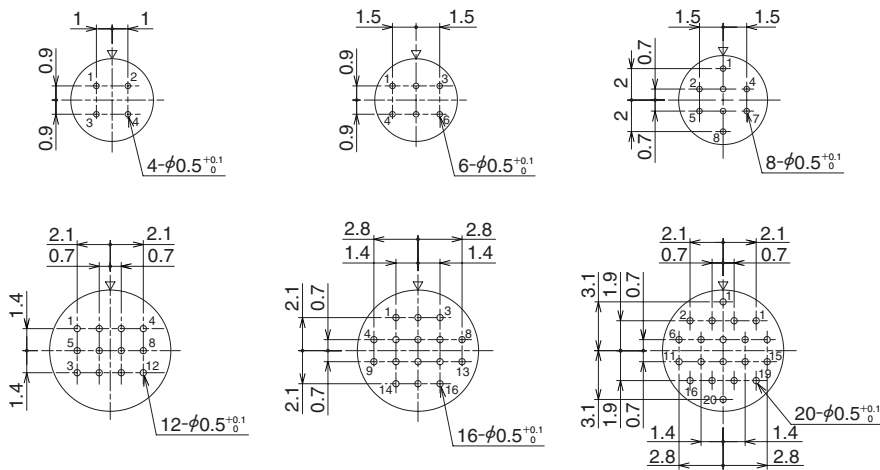

Note 1: The contact configuration is a view from the mating side.

Note 2: Plated through hole location and diameter tolerance:  $\pm 0.05$ .

**HR25A Series Miniature Push-Pull Circular Connectors**

**◆ Contact Position Arrangement**

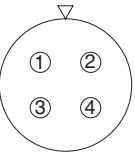
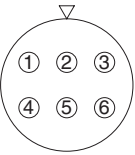
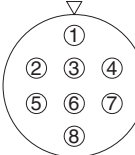
Shell size	7		
Contact configuration			
Number of contacts	4	6	8
Solderpot inner diameter	0.5mm		

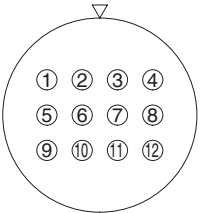
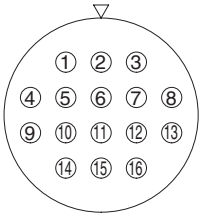
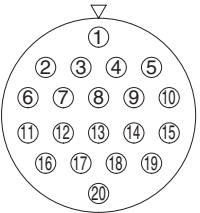
Shell size	9		
Contact configuration			
Number of contacts	12	16	20
Solderpot inner diameter	0.5mm		

Note 1: The contact configuration as viewed from the mating side.

Note 2: The ▽ symbol in the above illustrations indicates the mating side guide position of the receptacle.

**■ Precautions**

1. Make sure that turn off the power to the circuit before mating / un-mating the connector.
2. Make sure that use the connector of female contacts on the power side to the circuit.
3. Make sure that use the connector with the screw lock activated (thoroughly tightened).



**HIROSE ELECTRIC CO.,LTD.**

5-23,OSAKI 5-CHOME,SHINAGAWA-KU,TOKYO 141-8587,JAPAN  
 PHONE: 81-3-3491-9741, FAX: 81-3-3493-2933  
<http://www.hirose.com>  
<http://www.hirose-connectors.com>