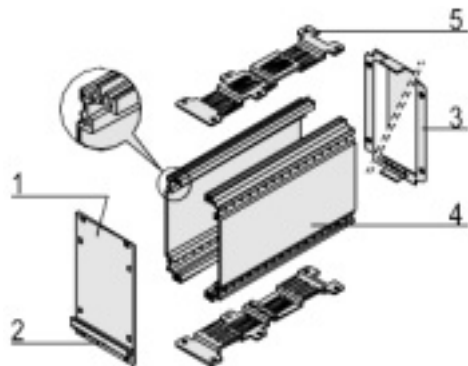

Frame-type 5 plug-in unit 3/6 U in kit form, unshielded
[Print page](#)

Article number: 24811-500

- Right and left extruded side panels with grooves for sliding in printed board (standard card position only on the left)
- Assembly of further boards via assembly of guide rails in the perforated covers
- Front panel unshielded, cover plates with perforation

Delivery comprises: kit

Item	Qty	Description
1	1	Front panel, Al, 2.5 mm, front anodised, rear colourless chromated
2	1	Handle, grey, PPE, UL 94 V-1
3a	1	Rear panel, Al, 1.5 mm, with cut-out for one connector
3b	1	Rear panel, Al, 1.5 mm, with cut-out for several connectors
4	2	Side panel, Al extrusion, with groove for one printed board
5	2	Cover, perforated, Al, 1 mm
6	1	Assembly kit

Technical data:

Height	Width	Description	Description
3 U	28 HP	T = 227 mm, front panel unshielded	Rear panel with cut-out for several connectors

Further Information:

	User manual
---	-------------

