



Right Angle "Flat" Toggle Switches for .100" Grid PC Layout - Refer to Page C18 for Other Options

TT Series

SEE PAGE C9 FOR PRODUCT SPECIFICATIONS

1 & 2 POLE FLAT

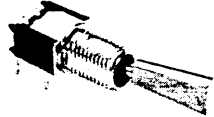
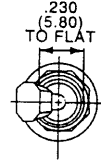
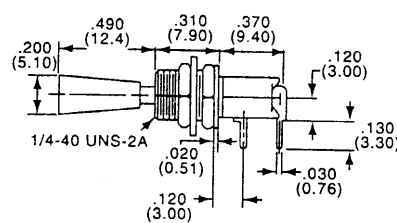
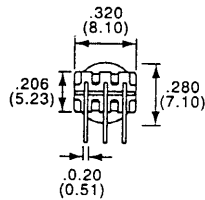
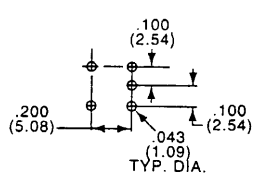

TT11DGRA7T1/4
Horizontal Actuation

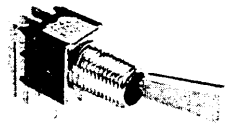
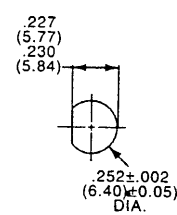
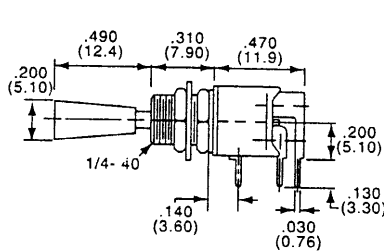
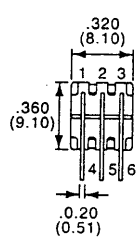
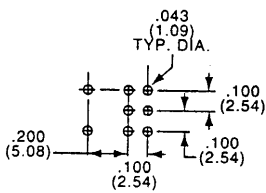

TT21NGRA7T1/4
Horizontal Actuation

Model	Type	Act. Code	P. M8			
TT11DGRA7T1/4	SPDT	D	On None On			
TT11EGRA7T1/4	SPDT	E	On Off On			
TT11FGRA7T1/4	SPDT	F	On None (On)			
TT21NGRA7T1/4	DPDT	N	On None On			
TT21PGRA7T1/4	DPDT	P	On Off On			
TT21PAGRA7T1/4	SP3T	PA	On On On			

(On) indicates momentary position

Pinned for Anti-Rotation

4 POLE FLAT

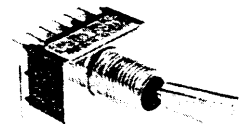
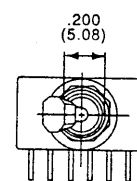
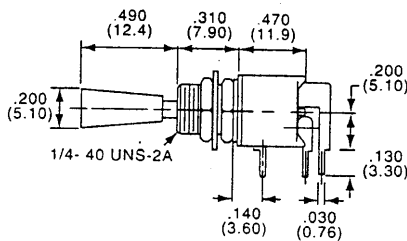
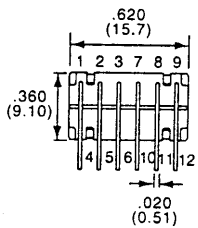
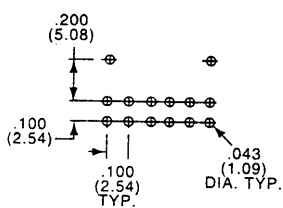

TT41NGRA7T14
Horizontal Actuation

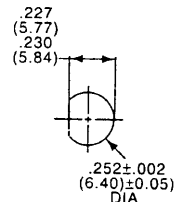

Model	Type	Act. Code	P. M8			
TT41NGRA7T1/4	4PDT	N	On None On			

Pinned for Anti-Rotation

Need more technical information?
Consult your local Augat sales office
listed on the back cover

TT Series "Wire Wrap" Termination Toggle Switches for .100" Grid PC Layout



SEE PAGE C9 FOR PRODUCT SPECIFICATIONS

For terminal connections refer to Code Chart on page M8-9

1 POLE

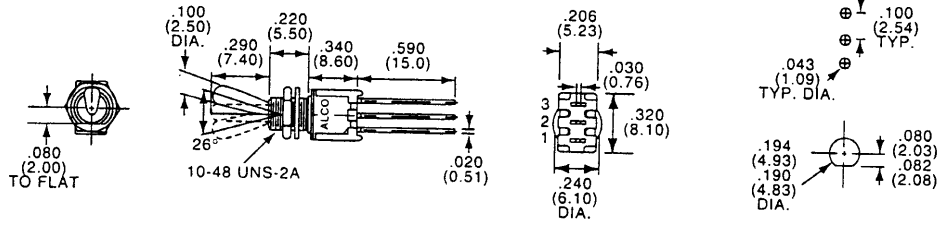
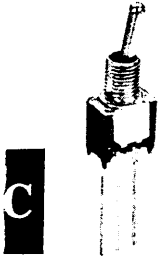

TT11DGWW2T

Model	Type	Act. Code	P. M8	↘	↓	↙
TT11DGWW2T	SPDT	D		On	None	On
TT11EGWW2T	SPDT	E		On	Off	On

2 POLE

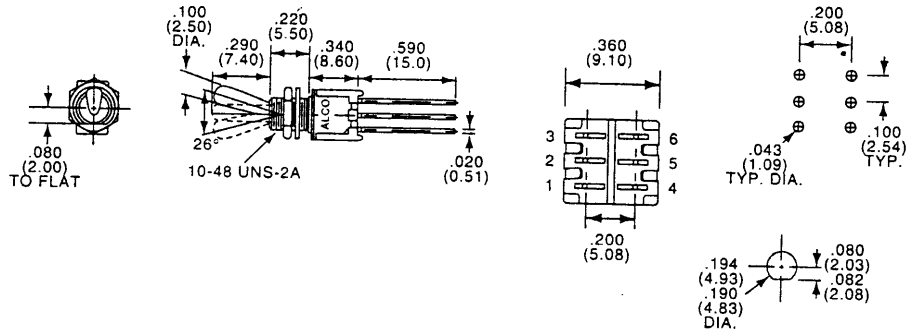

TT21NGWW2T

Model	Type	Act. Code	P. M8	↘	↓	↙
TT21NGWW2T	DPDT	N		On	None	On
TT21PGWW2T	DPDT	P		On	Off	On

4 POLE

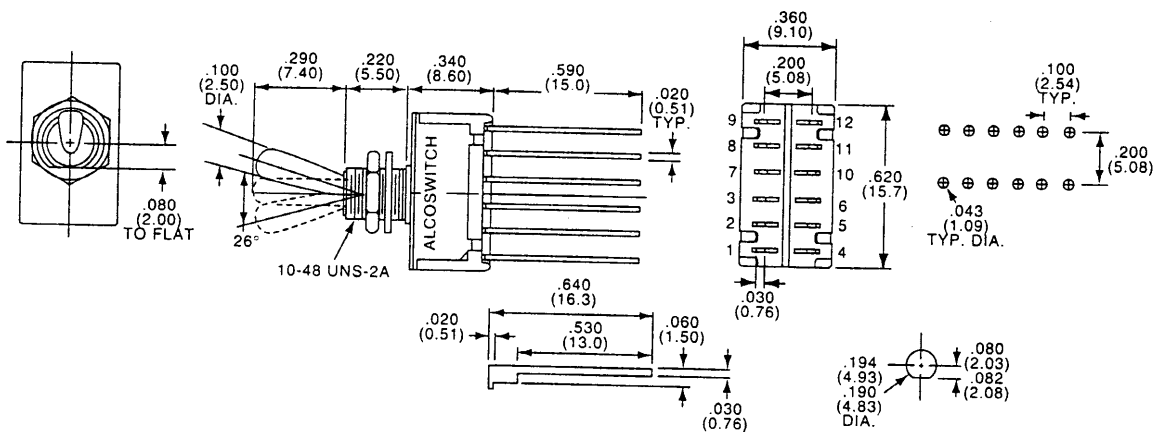
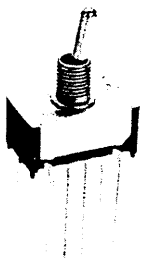

TT41NGWW2T

Model	Type	Act. Code	P. M8	↘	↓	↙
TT41NGWW2T	4PDT	N		On	None	On

AUGAT® Alcoswitch®
Quality and Innovation

C12

AUGAT Inc.
452 John L. Dietsch Blvd.
Attleboro Falls, MA 02763 USA
(508) 699-9800 FAX (800) 533-2526



"Wire Lug" Termination Toggle Switches TT Series

Round and Flat Actuators

SEE PAGE C9 FOR PRODUCT SPECIFICATION.
For terminal connections refer to Code Chart on page M8-

NOTICE: Wire lug terminals accept two No. 20 AWG wires.

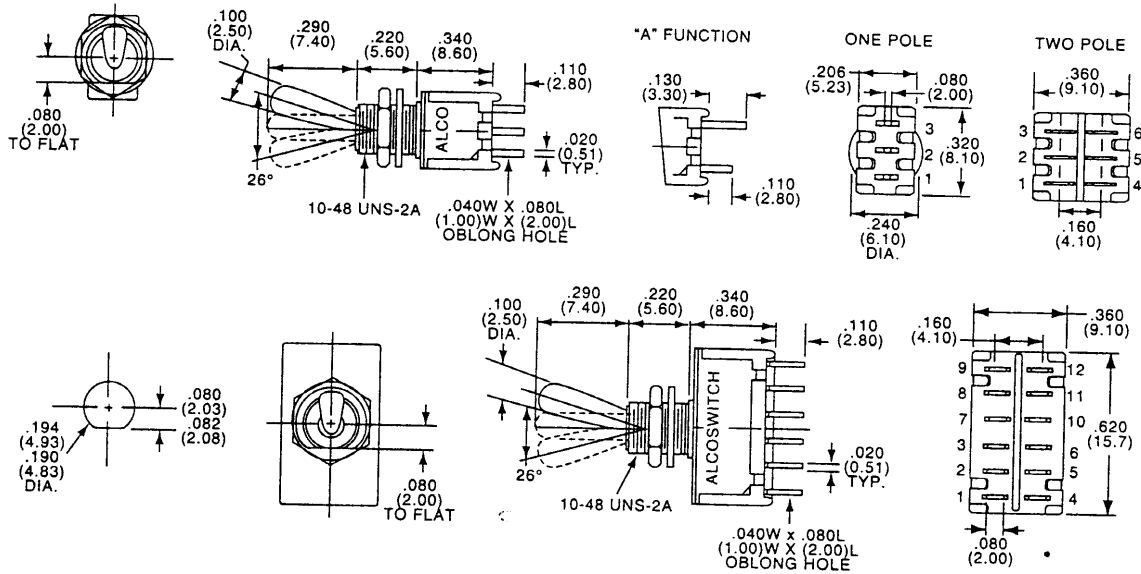

Model	Type	Act. Code	P. M8	↖	↕	↗	Model	Type	Act. Code	P. M8	↖	↕	↗
TT13A2T	SPST	A		On	None	Off	TT23N2T	DPDT	N		On	None	On
TT13D2T	SPDT	D		On	None	On	TT23P2T	DPDT	P		On	Off	On
TT13E2T	SPDT	E		On	Off	On	TT43N2T	4PDT	N		On	None	On
TT23K2T	DPST	K		On	None	Off					On	None	On

Note: No center terminal "A" or "K" action switches.

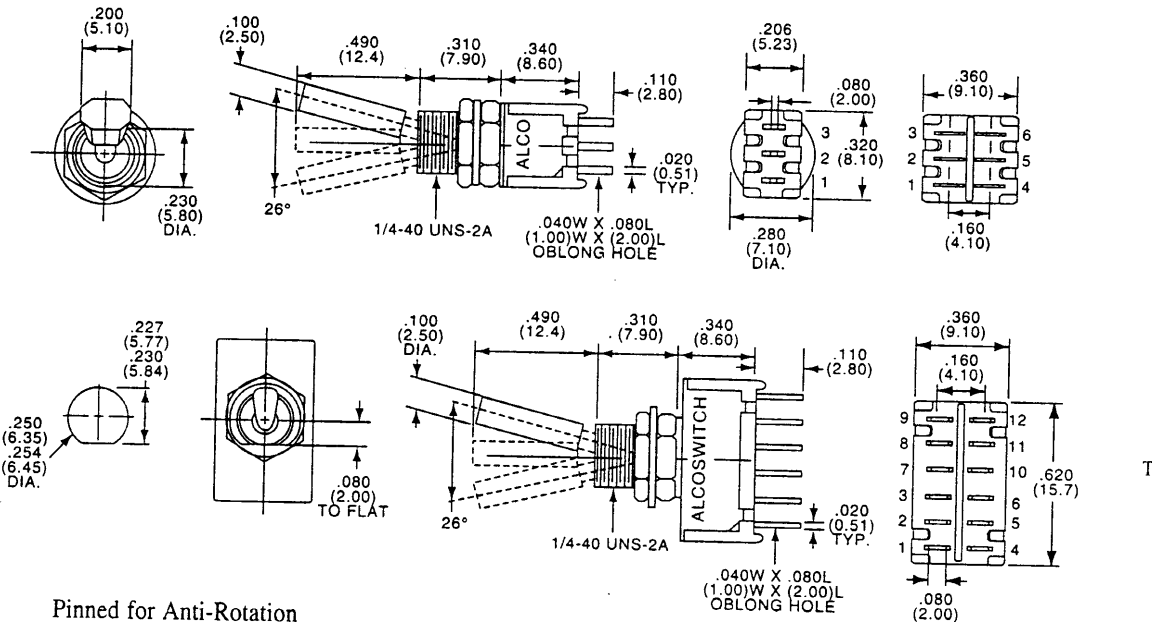

Model	Type	Act. Code	P. M8	↖	↕	↗	Model	Type	Act. Code	P. M8	↖	↕	↗
TT13D7T1/4	DPST	N		On	None	On	TT23P7T1/4	DPDT	P		On	Off	On
TT13E7T1/4	DPDT	P		On	Off	On	TT43N7T1/4	4PDT	N		On	None	On
TT23N7T1/4	DPST	N		On	None	On	TT43P7T1/4	4PDT	P		On	Off	On

Need more technical information?
Consult your local Augat sales office
listed on the back cover

TT Series Toggle Switches, Wire Lug Terminations "Long Actuators"



SEE PAGE C9 FOR PRODUCT SPECIFICATIONS For terminal connections refer to Code Chart on page M8-9

1 & 2 POLE



TT13D3T



TT23N3T

4 POLE

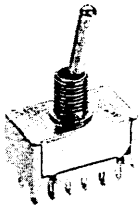

TT43N3T

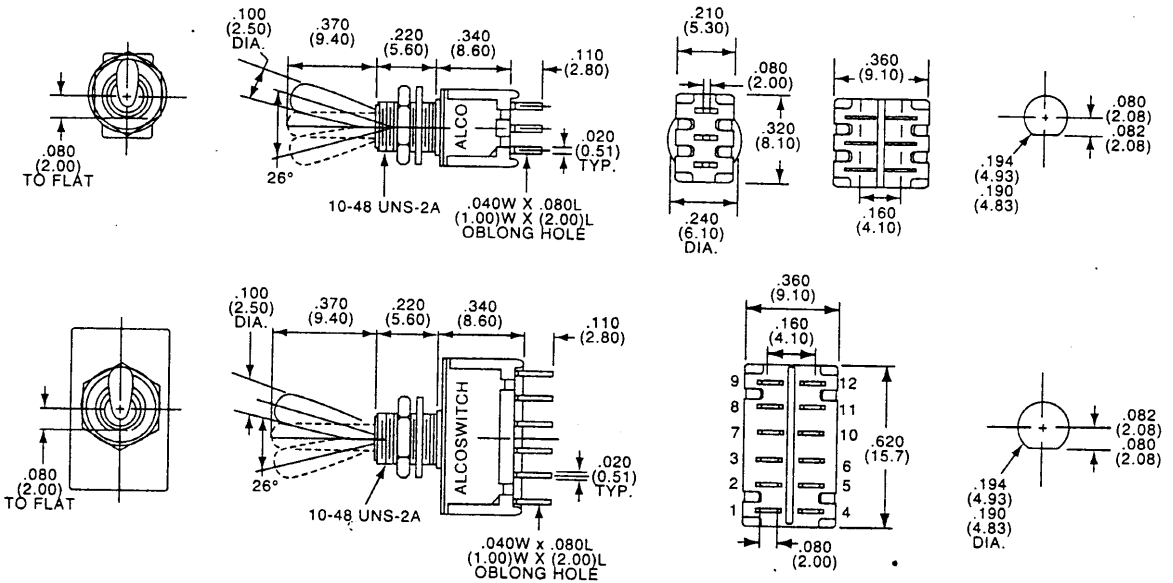

Model	Type	Act. Code	P. M8	↘	↓	↙	Model	Type	Act. Code	P. M8	↘	↓	↙
TT13A3T	SPST	A		On	None	Off	TT23P3T	DPDT	P		On	Off	On
TT13D3T	SPDT	D		On	None	On	TT23PA3T	SP3T	PA		On	On	On
TT13E3T	SPDT	E		On	Off	On	TT43N3T	4PDT	N		On	None	On
TT23K3T	DPST	K		On	None	Off	TT43P3T	4PDT	P		On	Off	On
TT23N3T	DPDT	N		On	None	On							

Note: No center terminal on "A" or "K" action switches.

1 & 2 POLE



TT13A9T1/4



TT23N9T1/4

4 POLE

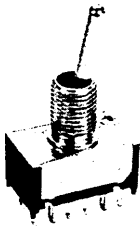

TT43N9T1/4

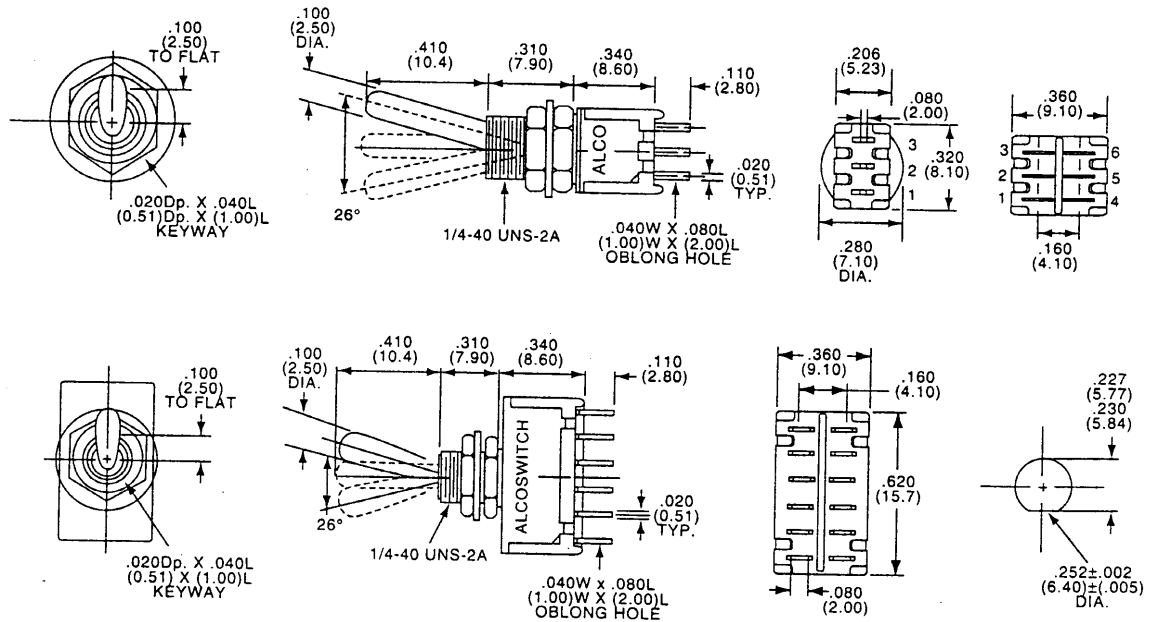

Model	Type	Act. Code	P. M8	↘	↓	↙	Model	Type	Act. Code	P. M8	↘	↓	↙
TT13A9T1/4	SPST	A		On	None	Off	TT23P9T1/4	DPDT	P		On	Off	On
TT13D9T1/4	SPDT	D		On	None	On	TT23PA9T1/4	SP3T	PA		On	On	On
TT13E9T1/4	SPDT	E		On	Off	On	TT43N9T1/4	4PDT	N		On	None	On
TT23K9T1/4	DPST	K		On	None	Off	TT43P9T1/4	4PDT	P		On	Off	On
TT23N9T1/4	DPDT	N		On	None	On							

Note: No center terminal on "A" or "K" action switches.