

THIS DRAWING IS UNPUBLISHED.

RELEASED FOR PUBLICATION

ALL RIGHTS RESERVED.

© COPYRIGHT - By Tyco Electronics Japan G.K.

LOC	DIST	REVISIONS			DATE	DWN	APVD
P	LTR	DESCRIPTION					
	F	REVISED		27SEP2013	H.U	N.Y	

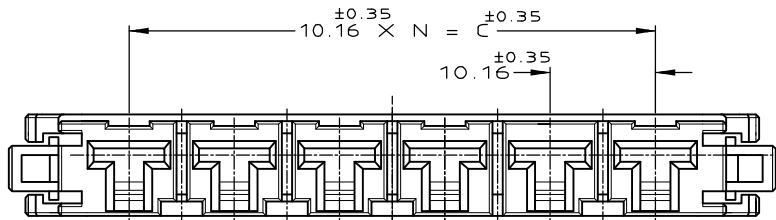
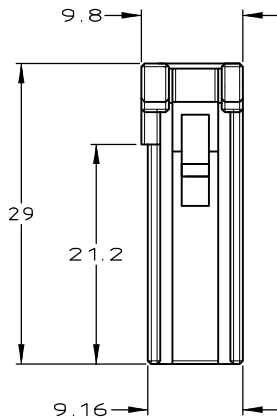
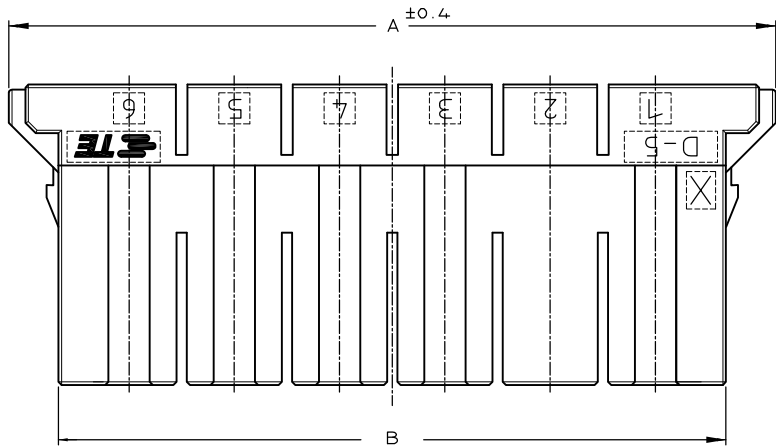
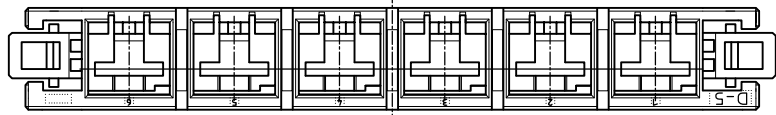

1-179958-6  
(KEYING CODE:X)

AS SHOWN

1-179958-6  
(KEYING CODE:X)

1-179958-4  
(KEYING CODE:X)

2-179958-6  
(KEYING CODE:Y)

2-179958-4  
(KEYING CODE:Y)

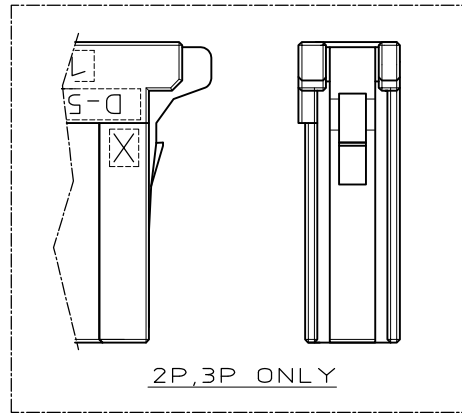

注記

- ① 材料: ハウジング: ガラス入り熱可塑性  
ポリエステル樹脂(94V-0),色: 黒
- ② ハウジング全面にテフロン塗装のこと
- ③ 製品規格 :108-5453

NOTES

- ① MATERIAL: HOUSING: GLASS FILLED THERMO PLASTIC  
POLYESTER(94V-0), COLOR: BLACK
- ② TO COAT ALL SURFACE OF HOUSING WITH TEFLON
- ③ PRODUCT SPEC :108-5453

FINISH	C	B	A	N	POS	COLOR	P/N
						BLACK	2-179958-6
	50.8	64.4	74	5	6	BLACK	1-179958-6
OBSOLETE						BLACK	<del>5-179958-4</del>
						BLACK	2-179958-4
OBSOLETE						BLACK	<del>1-179958-4</del>
						NATURAL	9-179958-3
						BLACK	2-179958-3
	20.32	33.92	45.92	2	3	BLACK	1-179958-3
						BLACK	2-179958-2
	10.16	23.76	35.76	1	2	BLACK	1-179958-2

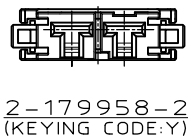
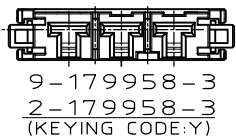
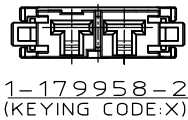
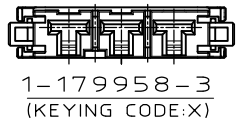

THIS DRAWING IS A CONTROLLED DOCUMENT.

DWN Y.ISHIKAWA 22MAR1995  
CHK S.MANABE 23MAR1995  
APVD S.MANABE 23MAR1995

DIMENSIONS: mm

TOLERANCES UNLESS OTHERWISE SPECIFIED:

0 PLC ± 0.2  
1 PLC ± 0.25  
2 PLC ± 0.3  
3 PLC ± 0.3  
4 PLC ± 0.3  
ANGLES ± 3'

MATERIAL △

FINISH

PRODUCT SPEC

APPLICATION SPEC

WEIGHT

CUSTOMER DRAWING

**STE** TE Connectivity

NAME SINGLE ROW REC HSG  
DYNAMIC D-5200

SIZE A3 CAGE CODE 00779 DRAWING NO C-179958 RESTRICTED TO -

SCALE 2:1 SHEET 1 OF 1 REV F