

4

3

2

1

THIS DRAWING IS UNPUBLISHED. RELEASED FOR PUBLICATION
 © COPYRIGHT - TE Connectivity Ltd. ALL RIGHTS RESERVED.

REVISIONS					
P	LTR	DESCRIPTION	DATE	DWN	APVD
1		NEW DRAWING	09MAY2019	GCM	AS

APPLICABLE FOR TE P/N
2351457-1

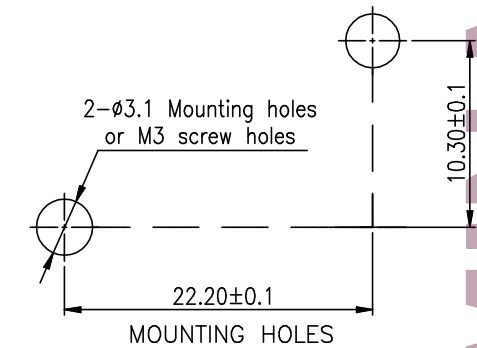
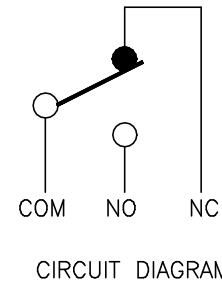
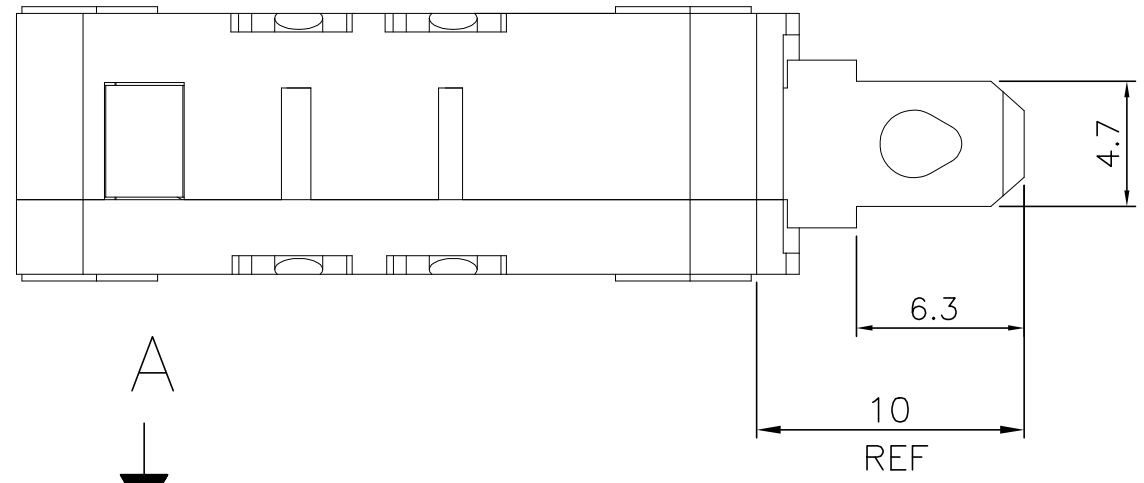

SOLDER TERMINAL AS SHOWN

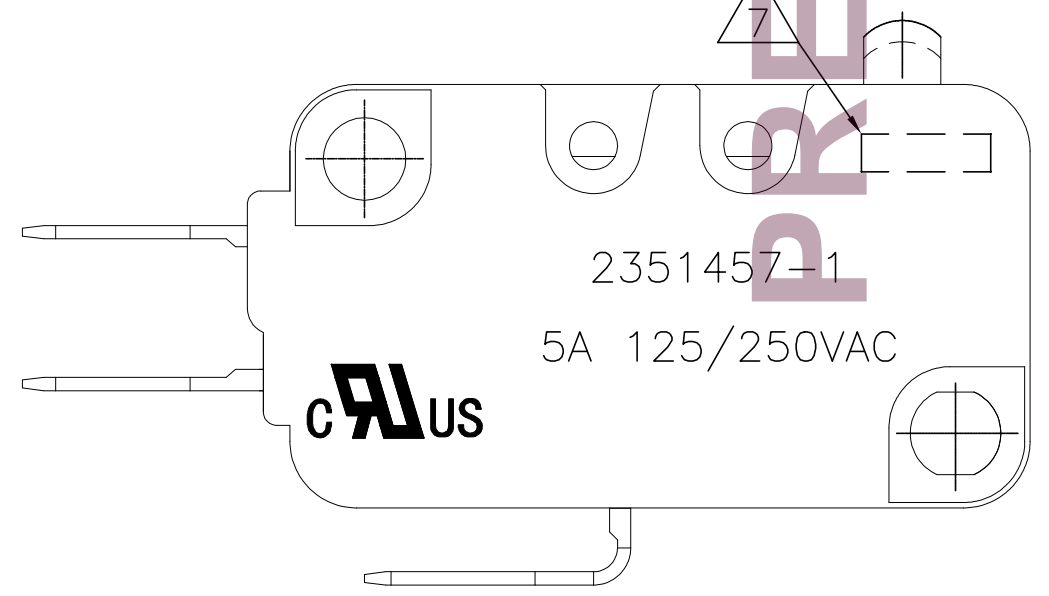
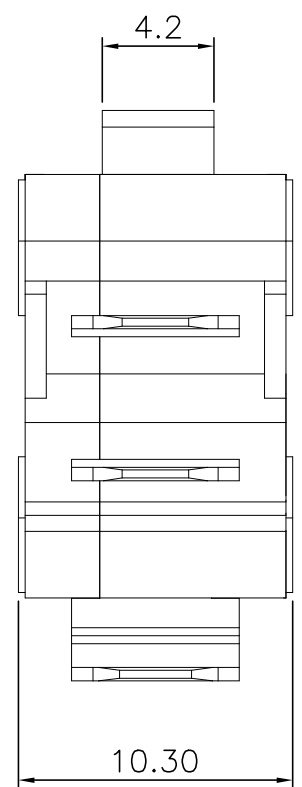
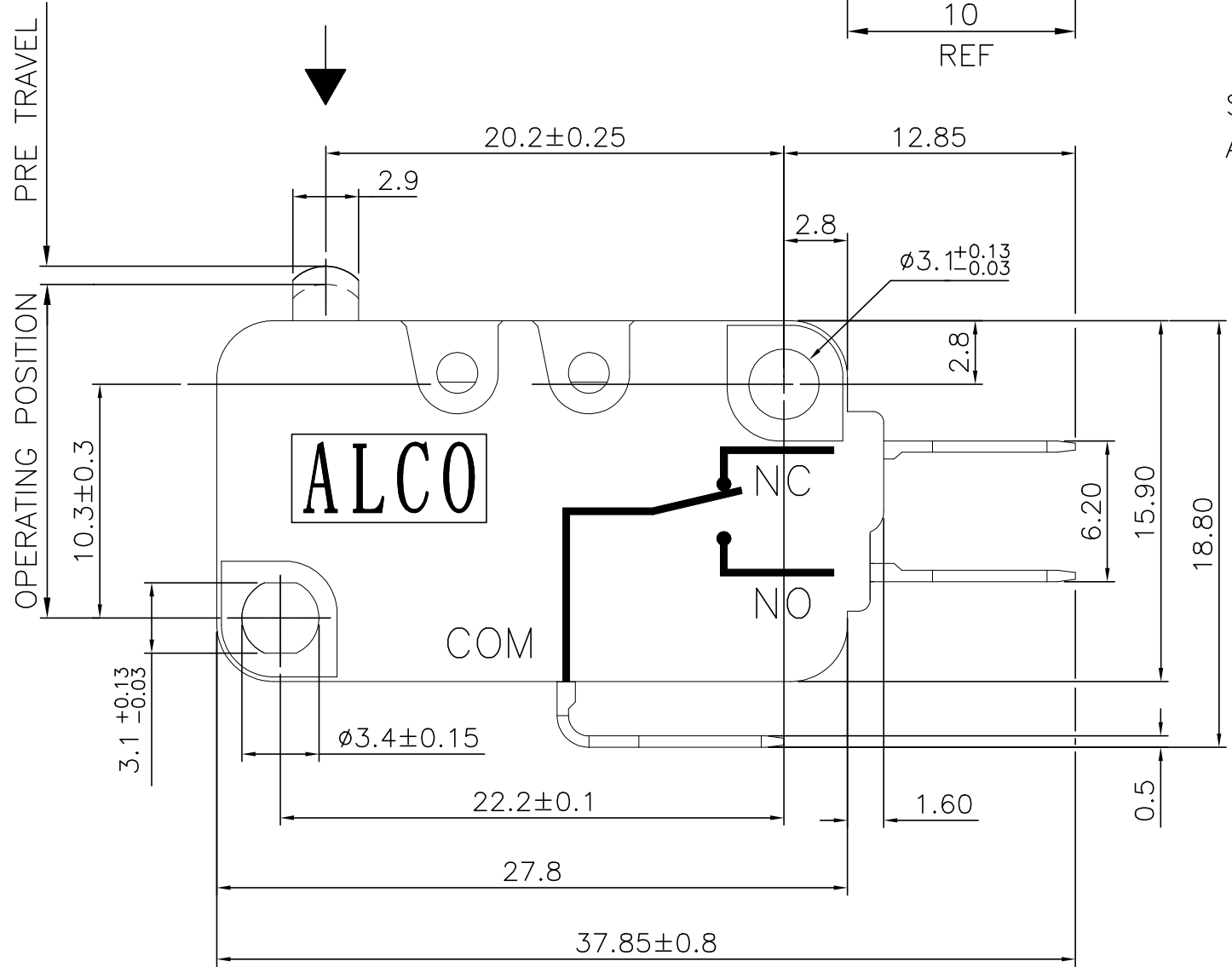

PRELIMINARY

THIS DRAWING IS A CONTROLLED DOCUMENT.		DWN	GANESH C M		09MAY2019
DIMENSIONS: mm		CHK	ALEXANDER SHARPE		09MAY2019
TOLERANCES UNLESS OTHERWISE SPECIFIED:		APVD	ALEXANDER SHARPE		09MAY2019
0 PLC ± -		NAME			
1 PLC ± 0.4		SWITCH, SUBMINIATURE SLD SNAP ACTION, PIN PLUNGER			
2 PLC ± 0.4		APPLICATION SPEC			
3 PLC ± -		SIZE			
4 PLC ± -		CAGE CODE			
ANGLES ± -		DRAWING NO			
FINISH		RESTRICTED TO			
MATERIAL		A3 00779			
		C=2351457			
		CUSTOMER DRAWING			
		SCALE		SHEET	
		NTS		1 of 3	
				REV 1	

THIS DRAWING IS UNPUBLISHED.

RELEASED FOR PUBLICATION

-, -

REVISIONS

© COPYRIGHT - TE Connectivity Ltd.

ALL RIGHTS RESERVED.

P	LTR	DESCRIPTION	DATE	DWN	APVD
-	-	SEE SHEET 1	-	-	-

NOTES:

- OPERATING CHARACTERISTICS ARE FOR OPERATION IN THE A DIRECTION ↓
- PACKAGING:
SWITCHES ARE BULK PACKAGED IN BAGS, 50 SWITCHES PER BAG, 20 BAGS PER BOX.
- COMPLIANCE:
THE CURRENT STATEMENT OF COMPLIANCE IS AVAILABLE AT TE.COM.
- MATERIAL AND FINISH:
COVER: THERMOPLASTIC, BLACK
BASE: THERMOPLASTIC, BLACK
BUTTON: THERMOPLASTIC, BLACK
CONTACTS: SILVER ALLOY, SILVER PLATED
TERMINALS: BRASS, SILVER PLATED
MOVING PLATE: BRASS, SILVER PLATED
SPRING PLATE: COPPER ALLOY
ACTION ARM: BRASS, SILVER PLATED
- SPECIFICATIONS:
CURRENT RATING: SEE TABLE
CONTACT RESISTANCE: 100mΩ MAXIMUM, INITIAL, AT FREE POSITION AND TOTAL TRAVEL POSITION, ACTUATE 3 TIMES BEFORE MEASUREMENT.
INSULATION RESISTANCE: 100MΩ MINIMUM, INITIAL, @ 500 V DC, 1 MINUTE
DIELECTRIC WITHSTANDING VOLTAGE, BETWEEN TERMINALS OF THE SAME POLARITY: 600 V AC, 50 TO 60 HZ FOR 1 MINUTE
DIELECTRIC WITHSTANDING VOLTAGE, BETWEEN EACH TERMINAL AND GROUND: 1500 V AC, 50 TO 60 HZ FOR 1 MINUTE
DIELECTRIC WITHSTANDING VOLTAGE, BETWEEN EACH TERMINAL AND NON-CURRENT CARRYING METAL PART: 1500 V AC, 50 TO 60 Hz FOR 1 MINUTE
INGRESS PROTECTION: IP40
- SOLDER PROCESS:
MANUAL SOLDERING: 350°C, 3 SECONDS MAXIMUM, 30 TO 40 WATTS. PREVENT SOLDER AND FLUX CONTACTING THE SWITCH BODY.
DO NOT OPERATE THE SWITCH DURING THE FIRST MINUTE AFTER SOLDERING.

7 DATE CODE:

① ② ③ ④

①	DAY	01 TO 31
②	MONTH	1 TO 9,X,Y,Z (X=10,Y=11,Z=12)
③	YEAR	00 TO 99
④	OTHER	N/A

8. CERTIFICATION: 

SILVER	SPDT	5,000,000 CYCLES, MINIMUM	100,000 CYCLES, MINIMUM	-40 TO +85°C/85% RELATIVE HUMIDITY MAXIMUM	-40 TO +85°C/60% RELATIVE HUMIDITY MAXIMUM	0.4 MAXIMUM	1.0 MINIMUM	14.7±0.4	1.2 MAXIMUM	5 gf MINIMUM	50 gf MAXIMUM	5A, 125VAC 5A, 250VAC	MOMENTARY	QUICK CONNECT, #187	SAJ35XXPP0N49SDTFAQ	2351457-2
													SOLDER		SAJ35XXPP0N49SDTSEQ	2351457-1
CONTACT FINISH	CONTACT FORM	MECHANICAL LIFE	ELECTRICAL LIFE	STORAGE TEMPERATURE RANGE/HUMIDITY RANGE	OPERATING TEMPERATURE RANGE/HUMIDITY RANGE	MOVEMENT DIFFERENTIAL	OVERTRAVEL	OPERATING POSITION	PRETRAVEL	RELEASE FORCE	OPERATING FORCE	CURRENT RATING	CONTACT CONFIGURATION	TERMINAL TYPE	TE SMART PART NUMBER	PART NUMBER

THIS DRAWING IS A CONTROLLED DOCUMENT.

DWN 09MAY2019 GANESH C M

CHK 09MAY2019 ALEXANDER SHARPE

APVD 09MAY2019 ALEXANDER SHARPE

PRODUCT SPEC

APPLICATION SPEC

WEIGHT

CUSTOMER DRAWING

 TE Connectivity Ltd.

NAME SWITCH, SUBMINIATURE SLD SNAP ACTION, PIN PLUNGER

SIZE	CAGE CODE	DRAWING NO	RESTRICTED TO
A3	00779	2351457	-

DIMENSIONS: mm

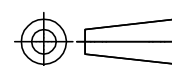

TOLERANCES UNLESS OTHERWISE SPECIFIED:

0 PLC	± -
1 PLC	± 0.4
2 PLC	± 0.4
3 PLC	± -
4 PLC	± -
ANGLES	± -

MATERIAL FINISH

PRELIMINARY