

This document is the property of Amphenol Corporation and is delivered on the express condition that it is not to be disclosed, reproduced or used, in whole or in part, for manufacture or sale by anyone other than Amphenol Corporation without its prior consent, & that no right is granted to disclose or to use any information in this document.

Customer Drawing

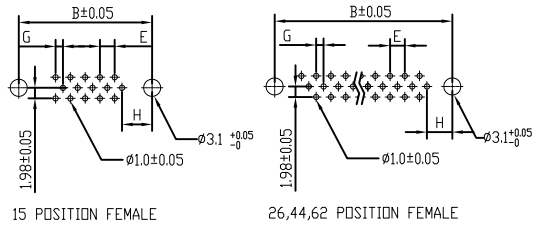

RECOMMENDED P.C.B. LAYOUT
TOLERANCE:±0.05MM

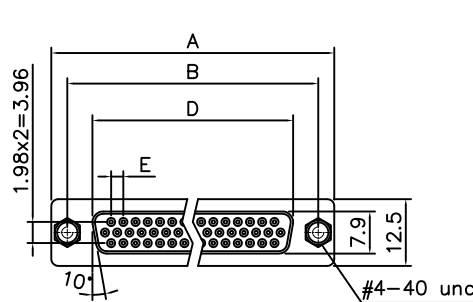
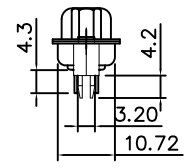
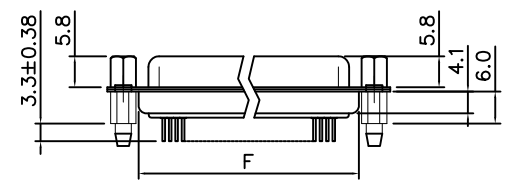

Dimensions

Positions	A	B	D	E	F	G	H
15	30.81	24.99	16.33	2.29	19.20	1.145	7.04
26	39.20	33.30	24.70	2.29	27.70	1.145	6.88
44	53.05	47.04	38.40	2.29	41.10	1.145	6.88
62	69.40	63.50	54.80	2.41	57.30	1.205	7.00

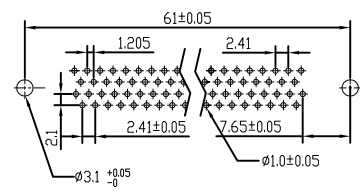
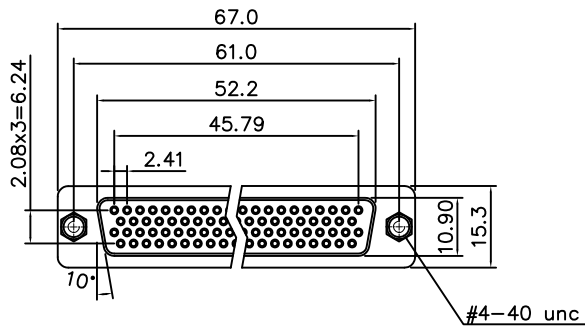

RECOMMENDED P.C.B. LAYOUT
TOLERANCE:±0.05MM

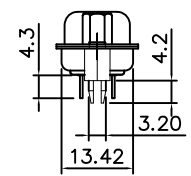
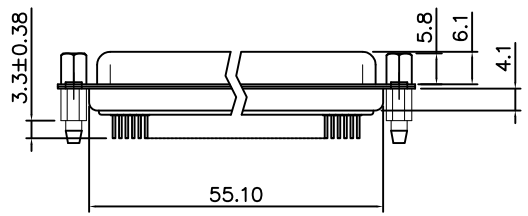

REVISIONS				
SYM	ECN	DESCRIPTION	DATE	APPROVED
1	HK--	First Release Drawing	01/04/19	IP

D-SUB TECHNICAL DATA

- SHELL :** Steel, 100u" min tin plated over 50u" min nickel over 50u" min Copper
- BODY :** PBT UL 94V-0 Color: Black
- CONTACTS :** Copper Alloy
30u"gold over 50u" min nickel on mating area.
100u" min tin over 50u" min nickel on solder area.
- BOARDLOCK:** Brass, Tin plated.
- SCREWLOCK:** Brass, Nickel plated.
- ELECTRICAL :** Voltage rating 250 V Rms
Current rating 3A.
Withstanding Voltage >1000 V Rms
Insulation resistance >1000 M Ohms
Contact resistance 20 mOhms max.
- MARKING :** Amphenol...(Series No.)
Commercial reference
Manufacturing date

PRODUCT CODE

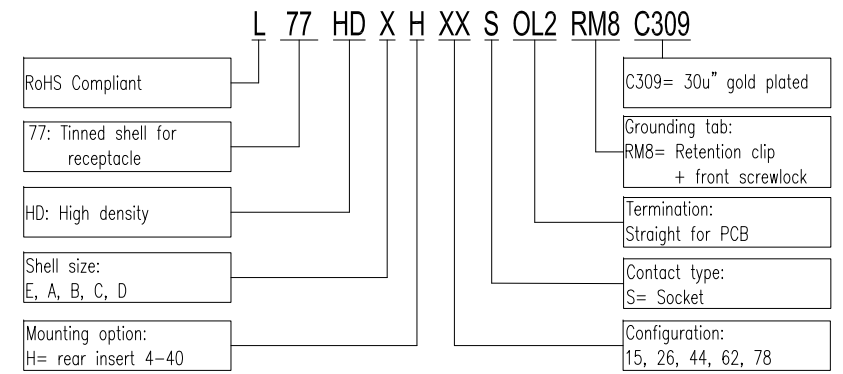

UNLESS OTHERWISE SPECIFIED TOLERANCES U.S. METRIC	APPROVAL		DATE									
	.X +/- 0.50	DRAWN	Simon Chen	01/04/19								
.XX +/- 0.30	CHECKED	Tony Tang	01/04/19									
.XXX +/- 0.20	CHECKED											
FRACTIONS +/- 5'	DRAWING FILE :											
ANGLES +/-	ANGLE OF PROJECTION											
REMOVE SHARP EDGES												
DIMENSIONS U.S. INCHES METRIC MM	<table border="1"> <tr> <td>SIZE</td> <td>DRAWING NO.</td> <td>REV.</td> </tr> <tr> <td>A4</td> <td>L77HDXXHXXSOL2RM8C309</td> <td>1</td> </tr> <tr> <td>SCALE</td> <td>NONE</td> <td>SHEET 1 OF 1</td> </tr> </table>			SIZE	DRAWING NO.	REV.	A4	L77HDXXHXXSOL2RM8C309	1	SCALE	NONE	SHEET 1 OF 1
SIZE	DRAWING NO.	REV.										
A4	L77HDXXHXXSOL2RM8C309	1										
SCALE	NONE	SHEET 1 OF 1										

Amphenol

TITLE: D-SUB connector, HD Series