

Explosion proof switches

Honeywell explosion proof switches are designed specifically for use in hazardous locations. To comply with explosion proof requirements, the flame path within the housing is designed to contain and cool the escaping hot gases that otherwise could cause an explosion outside the switch.

Switches are available with UL/CSA for North America. See information below and product pages for details. In Europe, the usage is governed under the European Directive on Equipment and Protective Systems Intended for Use in Potentially Explosive Atmospheres (94/9/EC) commonly referred to as the ATEX Directive.

The BX, CX and GXE product families comply to the following ATEX Directive: EExd IIC T6 Category II 2 GD

The 14CE100 product family complies to the following ATEX Directive: EExd IIC T6 Category II 2 G

NEMA TYPE 7, CLASS I FLAMMABLE GASES OR VAPORS

Type 7 enclosures are for use indoors in locations classified as Class I, Groups B, C, or D by the National Electrical Code.

Group B — (only switches so noted in the order guides include this listing). Atmospheres containing hydrogen or manufactured gas.

Group C — atmospheres containing diethyl ether, ethylene, or cyclopropane.

Group D — Atmospheres containing gasoline, hexane, butane, naptha, propane, acetone, toluene or isoprene.

Division 1

Locations in which hazardous agents are present under normal operating conditions.

Division 2

Locations in which hazardous agents may be present only in case of accidental rupture or breakdown.

All Honeywell listings covered in Division 1 are also covered in the same groups in Division 2.

NEMA TYPE 9, CLASS II COMBUSTIBLE DUSTS

Type 9 enclosures are for use in indoor locations classified as Class II, Groups E, F or G, as defined in the National Electrical Code.

Group E — Atmospheres containing metal dust.

Group F — Atmospheres containing carbon black, coal dust or coke dust.

Group G — Atmospheres containing flour, starch or grain dust.

ATEX EExd

EExd	II	c	T6	Category II 2	G	D
Flameproof enclosure	Places with potentially explosive atmospheres, other than mines susceptible to fire damp	Atmosphere may contain gases from groups A, B or C from table in EN50014, Annex A	Maximum surface temperature of 85 °C (185 °F)	Areas in which an explosion proof atmosphere is likely to occur	Gas could be present	Dust could be present



14CE100 Series Miniature Enclosed, Explosion Proof Switches



The 14CE100 Series has been designed for use in explosive environments. It is approved to meet the requirements of the Low Voltage directive and is CE marked. The prewired construction allows for ease of installation where space is at a premium and external operating conditions can be difficult.

Mechanical life:	10 million
Sealing:	Standard IP65, NEMA 1, 3 Boot sealed IP67, NEMA 1, 3, 4 12, 13
Operating temperature:	0 °C to 70 °C (32 °F to 158 °F)
Approvals:	CE, PTB 98 ATEX 1064 X EExd IIC T6 Category II 2 G AC14 D300 DC13 R300 11,8 N max.
Operating force (OF):	1,8 mm (0.71 in) max.
Pretravel (PT):	3,0 mm (0.118 in) min.
Overtravel (OT):	0,1mm (0.004 in) max.
Differential travel (DT):	
Contacts:	Standard Silver -*G Gold
Connection:	Harmonised CENELEC 4 x 0,75 mm ² cable
Switching options:	SPDT
	Single Pole, Double Throw Snap action contacts (1NC/1NO)

Actuators

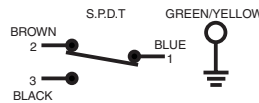

Top pin plunger

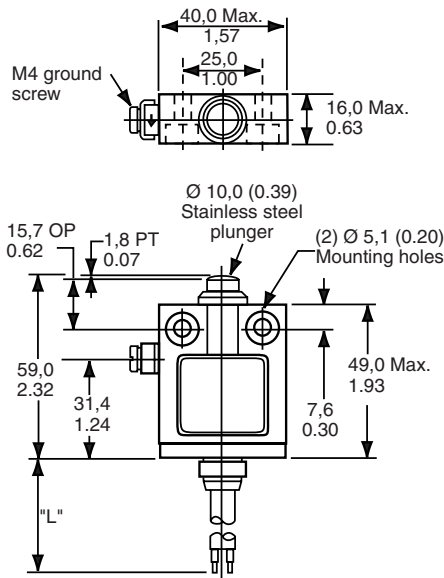

CABLE LENGTH	REFERENCE
1 m (3.3 ft)	14CE101-1
2 m (6.6 ft)	14CE101-2
3 m (9.9 ft)	14CE101-3
4 m (13.2 ft)	14CE101-4
5 m (16.5 ft)	14CE101-5
6 m (19.8 ft)	14CE101-6
10 m (33.0 ft)	14CE101-10

Top roller plunger, parallel

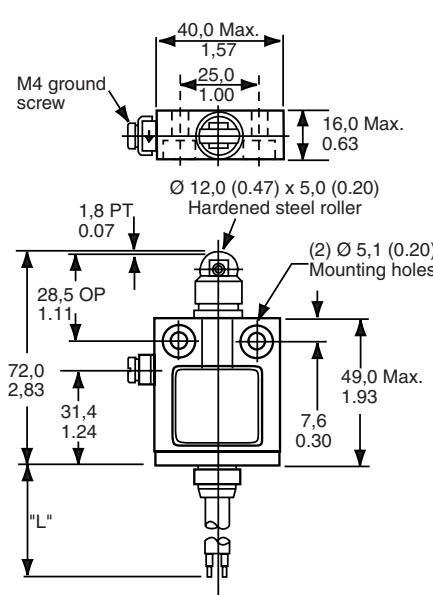

CABLE LENGTH	REFERENCE
1 m (3.3 ft)	14CE102-1
3 m (9.9 ft)	14CE102-3
3 m (9.9 ft) Gold contacts	14CE102-3G
5 m (16.5 ft)	14CE102-5
6 m (19.8 ft)	14CE102-6
6 m (19.8 ft) Gold contacts	14CE102-6G
8 m (26.4 ft)	14CE102-8
12 m (39.6 ft)	14CE102-12
15 m (49.5 ft)	14CE102-15

Top roller plunger, perpendicular

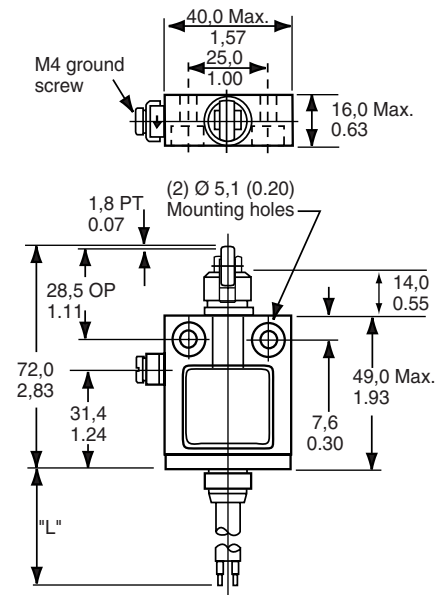

CABLE LENGTH	REFERENCE
1 m (3.3 ft)	14CE103-1
3 m (9.9 ft)	14CE103-3

Boot sealed

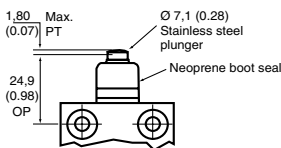

CABLE LENGTH	REFERENCE
1 m (3.3 ft)	14CE118-1
6 m (19.8 ft)	14CE118-6
10 m (33.0 ft)	14CE118-10

GXE Series Explosion Proof Limit Switches



Actuators



The GXE Series explosion proof limit switches are designed specifically for use in hazardous applications. The GXE enclosure is fully potted and has sealing protection of IP66/67 as per IEC/EN 60529. The entire GXE Series complies with the European Directive on Equipment and Protective Systems Intended for Use in Potentially Explosive Atmospheres (94/9/EC) commonly referred to as the ATEX Directive.

Mechanical life: 2 million
Sealing: IP66/67, EN 60529
Operating temperature: -20 °C to 75 °C (-4 °F to 167 °F)
Approvals: CE, EN 50014, EN 50018, EN 50281-1-1
 KEMA 00 ATEX 2103 X EExd IIC T6 Category II 2 GD
 AC15
 DC13
 Silver
 5 metre, HO5VV-F, 3 x 0,75 mm² cable
 Single Pole, Double Throw
 Snap action contacts (1NC/1NO)

Contacts:
Connection:
Switching options:
 SPDT

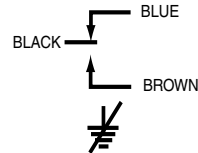

GXE Series

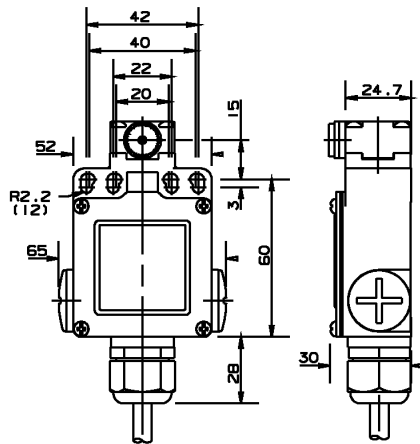

Operating force max. (OF): 16 N (3.6 lb)

OPTIONS

Side rotary roller lever

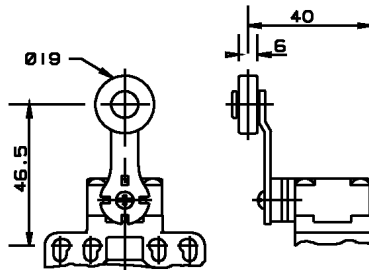

Overtravel min. (OT): 49°
Differential travel max. (DT): 8°
Operating position max. (OP): 26°

REFERENCE
 GXE51A1B

Top roller plunger, parallel

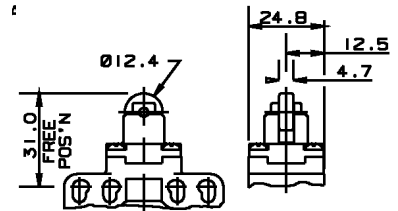

Overtravel min. (OT): 6,0 mm (0.236 in)
Differential travel max. (DT): 0,5mm (0.020 in)
Operating position max. (OP): 2,0 mm (0.079 in)

REFERENCE
 GXE51C

Top pin plunger

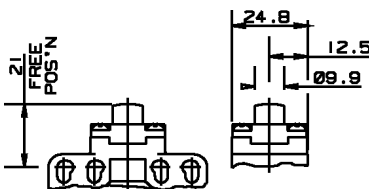

Overtravel min. (OT): 6,0 mm (0.236 in)
Differential travel max. (DT): 0,5mm (0.020 in)
Operating position max. (OP): 2,0 mm (0.079 in)

REFERENCE
 GXE51B

EX Series Standard Explosion Proof Switches



Actuators



Sealing:	NEMA 1, 7 (Class I, Division I, Groups C, D) 9, (Class II, Division I, Groups E, F, G)
Operating temperature:	Standard -40 °C to 71 °C (-40 °F to 160 °F) High 100 hr @ 400 °F
Approvals:	UL, CSA
Conduit:	½ in - 14NPT
Contacts:	Silver
Electrical ratings:	
A	UL/CSA Rating: 15 A, 125, 250 or 480 Vac; 1/8 Hp, 125 Vac; 1/4 Hp, 250 Vac; 1/2 A, 125 Vdc; 1/4 A, 250 Vdc.
B	UL/CSA Rating: 20 A, 125, 250 or 480 Vac; 10 A, 125 Vac "L"; 1 Hp, 125 Vac; 2 Hp, 250 Vac; 1/2 A, 125 Vdc; 1/4 A, 250 Vdc.
C	UL/CSA Rating: 10 A, 125 or 250 Vac; 0.3 A, 125 Vdc; 0.15 A, 250 Vdc
D	UL/CSA Rating: 10 A, 125, 250 or 480 Vac; 1/2 A, 125 Vdc; 1/4 A, 250 Vdc.
E	UL Rating: 1 A, 125 Vac.

Switching options:

SPDT
Single Pole, Double Throw
Snap action contacts (1NC/1NO)

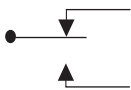

DPDT
Double Pole, Double Throw
Snap action contacts (2NC/2NO)

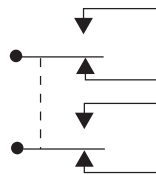

The EX Series features the smallest UL listed housings available for use in hazardous locations. Flame paths within the housing cool exploding gases below the kindling temperature before they reach the explosive gases surrounding the housing.

Options available include single or double conduit connection.

These switches are not sealed against liquids and should not be used where there will be liquid splash. If a weather sealed explosion proof switch is required please select from the CX or LSX/BX series.

Side rotary actuated switches

OPTIONS

No lever

Note: Levers are ordered separately (see pages 71-73 for details)

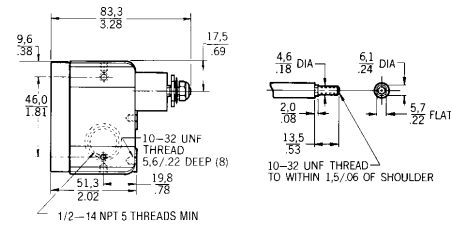

Operating force max. (OF):

Electrical rating A	0,22 N m (31.25 in oz)
Electrical rating B	3,34 N to 8,90 N (0.75 lb to 2.0 lb)

Pretravel max. (PT):

5,56 mm (0.219 in) 8°

Overtravel max. (OT):

Electrical rating A	90°
Electrical rating B	25°

Differential travel max. (DT):

Electrical rating A	0,18 mm (0.007 in) 0.25°
Electrical rating B	0,3 mm (0.012 in) 4°

ACTUATION	CONTACT	ELECTRICAL RATING	REFERENCE
CW	SPDT	A	EX-AR20
CCW	SPDT	A	EX-AR230
CW	SPDT	B	EXA-AR20

Roller lever

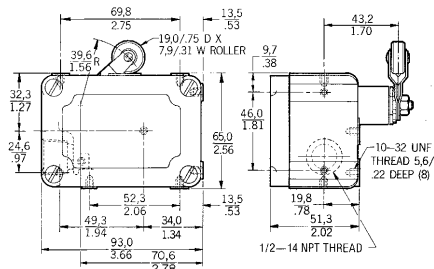

Roller material:	Bronze
Operating force max. (OF):	
Electrical rating A	
Clockwise (CW)	2,22 N to 5,56 N (0.5 lb to 1.25 lb)
Counter clockwise (CCW)	11,1 N (2.5 lb)
Electrical rating B	3,34 N to 8,90 N (0.75 lb to 2.0 lb)
Pretravel max. (PT):	
Electrical rating A, B	
Clockwise (CW)	5,56 mm (0.219 in) 8°
Counter clockwise (CCW)	1,65 mm (0.065 in) 3.5°
Overtravel max. (OT):	
Electrical rating A	
Clockwise (CW)	90°
Counter clockwise (CCW)	25°
Electrical rating B	25°
Differential travel max. (DT):	
Electrical rating A	0,18 mm (0.007 in) 0.25°
Electrical rating B	0,3 mm (0.012 in) 4°

ACTUATION	CONTACT	ELECTRICAL RATING	REFERENCE
CW	SPDT	A	EX-AR
CCW	SPDT	A	EX-AR30
CW/Class 1 Group B	SPDT	A	EX-AR800
CCW/Class 1 Group B	SPDT	A	EX-AR830
CW/High temperature	SPDT	A	EX-AR400
CW	SPDT	B	EXA-AR
CW/No mounting bracket	SPDT	B	EXA-AR62
CW/Nylon roller	SPDT	A	EX-AR182
CW/No mounting bracket	SPDT	A	EX-AR141

CW or CCW actuation, no return spring, low operating force

Operating force max. (OF): 0,56 N (2 oz)

ACTUATION	CONTACT	ELECTRICAL RATING	REFERENCE
CW/CCW/No mounting bracket	SPDT	A	EX-AR16

Maintained contact

Operating force max. (OF): 3,34 N (0.75 lb)
Pretravel max. (PT): 5,56 mm (0.219 in) 8°
Overtravel max. (OT): 90°

ACTUATION	CONTACT	ELECTRICAL RATING	REFERENCE
CW	SPDT	A	EX-XR3

DPDT, Prelead with 0,91 m (3 ft) leadwire

Operating force max. (OF):
 Clockwise (CW) 2,22 N to 6,67 N (0.5 lb to 1.5 lb)
 Counter clockwise (CCW) 12,2 N (2.75 lb)
Pretravel max. (PT): 6,35 mm (0.250 in)
Overtravel max. (OT): 25°
Differential travel max. (DT): 2,77 mm (0.109 in) 4°
Sealing: NEMA Class 1 Group B

ACTUATION	CONTACT	ELECTRICAL RATING	REFERENCE
CW	DPDT	C	EXD-AR-3
CCW	DPDT	C	EXD-AR30-3

Hermetically sealed

Operating force max. (OF):
 Clockwise (CW) 2,22 N to 6,67 N (0.5 lb to 1.5 lb)
 Counter clockwise (CCW) 11,1 N (2.5 lb)
Pretravel max. (PT):
 Clockwise (CW) 5,56 mm (0.219 in) 8°
 Counter clockwise (CCW) 1,65 N (0.065 in) 3.5°
Overtravel max. (OT): 25°
Differential travel max. (DT): 0,64 mm (0.025 in)
Sealing: NEMA Class 1 Group B

ACTUATION	CONTACT	ELECTRICAL RATING	REFERENCE
CW/3,2 m (10.5 ft) leadwire	SPDT	E	EXH-AR3
CCW/0,91 m (3 ft) leadwire	SPDT	E	EXH-AR33
CW/0,91 m (3 ft) leadwire	SPDT	E	EXH-AR7

2 Conduit openings

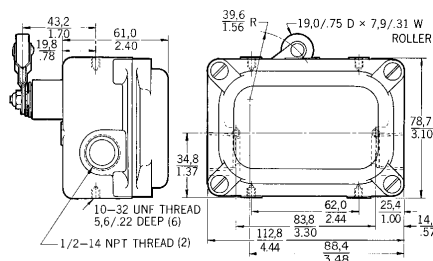

Operating force max. (OF):
 Electrical rating A 2,22 N to 5,56 N (0.5 lb to 1.25 lb)
 Electrical rating B 3,61 N to 8,90 N (0.8 lb to 2 lb)
 Electrical rating C 2,22 N to 6,67 N (0.5 lb to 1.5 lb)
Pretravel max. (PT):
 Electrical rating A, B 5,56 mm (0.219 in) 8°
 Electrical rating C 6,35 mm (0.250 in)
Overtravel max. (OT):
 Electrical rating A 90°
 Electrical rating B, C 25°
Differential travel max. (DT):
 Electrical rating A 0,18 mm (0.007 in) 0.25°
 Electrical rating B 0,3 mm (0.012 in) 0.5°
 Electrical rating C 2,77 mm (0.109 in) 4°

CONTACT	ELECTRICAL RATING	REFERENCE
DPDT	C	4EX1-3
SPDT	B	2EX1
SPDT	A	1EX1

**EX Series
Side rotary actuated switches (continued)**

Cross roller lever, rotated 90°

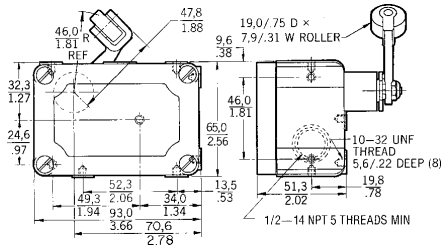

Operating force max. (OF): 2,22 N to 5,56 N (0.5 lb to 1.25 lb)
Pretravel max. (PT): 5,56 mm (0.219 in) 8°
Overtravel max. (OT): 90°
Differential travel max. (DT): 0,18 mm (0.007 in) 0.25°

CW	CONTACT	ELECTRICAL RATING	REFERENCE
	SPDT	A	EX-CR

Rod lever

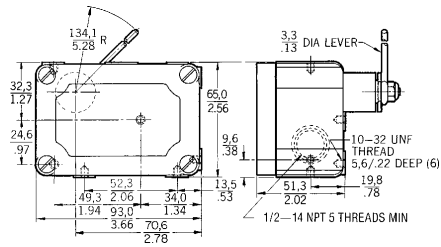

Operating force max. (OF): 0,56 N (2 oz)
Pretravel max. (PT): 18°
Overtravel min. (OT): 40°

CW/No mounting bracket	CONTACT	ELECTRICAL RATING	REFERENCE
	SPDT	A	EX-AR1613

Overtravel plunger actuated switches

OPTIONS

Top pin plunger

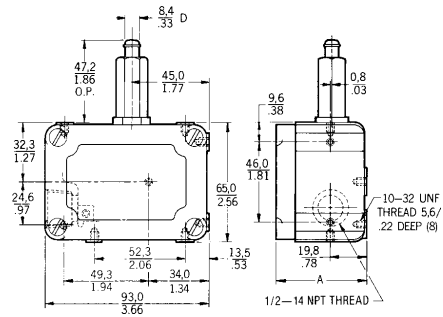

Operating force max. (OF):
 Electrical rating A, C 13,34 N (3.0 lb)
 Electrical rating B 8,90 N (2 lb)
Pretravel max. (PT):
 Electrical rating A 1,98 mm (0.078 in)
 Electrical rating B 1,27 mm (0.050 in)
 Electrical rating C 3,96 mm (0.156 in)
Overtravel min. (OT):
 Electrical rating A 4,78 mm (0.188 in)
 Electrical rating B 3,18 mm (0.125 in)
 Electrical rating C 3,48 mm (0.141 in)
Differential travel max. (DT):
 Electrical rating A 0,10 mm (0.004 in)
 Electrical rating B 0,23 mm (0.009 in)
 Electrical rating C 1,52 mm (0.060 in)

	CONTACT	ELECTRICAL RATING	REFERENCE
No mounting bracket	SPDT	A	EX-Q
High temperature	SPDT	A	EX-Q62
Low OF	SPDT	B	EXA-Q

Sealing NEMA Class 1 Group B

	CONTACT	ELECTRICAL RATING	REFERENCE
	SPDT	A	EX-Q800
Preleaded with 0,91 m (3 ft) leadwire	DPDT	C	EXD-Q-3

Boot sealed

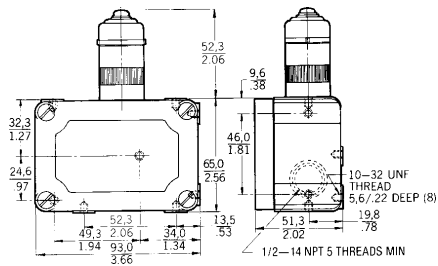

Operating force max. (OF):	
Electrical rating D	13,34 N (3.0 lb)
Electrical rating B	15,57 N (3.5 lb)
Pretravel max. (PT):	
Electrical rating D	1,98 mm (0.078 in)
Electrical rating B	2,77 mm (0.109 in)
Overtravel min. (OT):	
Electrical rating D	4,78 mm (0.188 in)
Electrical rating B	3,18 mm (0.125 in)
Differential travel max. (DT):	
Electrical rating D	0,10 mm (0.004 in)
Electrical rating B	0,23 mm (0.009 in)

	CONTACT	ELECTRICAL RATING	REFERENCE
Class 1 Group B	SPDT	D	EX-M15
	SPDT	B	EXA-N

Manually actuated

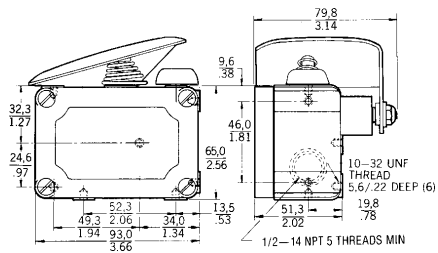

Operating force max. (OF):	11,1 N (2.5 lb)
-----------------------------------	-----------------

	CONTACT	ELECTRICAL RATING	REFERENCE
	SPDT	A	EX-AR50

CX Series Weather Sealed Explosion Proof Switches



Actuators



CX switches, as are the LSX/BX Series, are built especially for outdoor use in hazardous atmospheres. These enclosures are constructed to withstand the pressure of an internal explosion.

O-ring seals make the enclosure weatherproof but are outside of required flame paths so explosion proof requirements are maintained.

As factory assembled, all basic switches operate on clockwise and counterclockwise rotation. The actuating mechanism can be field adjusted for CW or CCW operation only.

Analog output, 4 mA to 20 mA, is available.

Basic switches operate nearly simultaneously in multiple switch devices.

Shafts of devices without shaft restoring force can be rotated through 360°.

Sealing:

NEMA
UL listed

CSA certified

Operating temperature:

Approvals:

Housing:

Conduit:

Contacts:

Electrical Ratings:

A	UL/CSA Rating: L96	1, 3, 4, 4X, 6, 6P, 7, 9 and 13 Class I, Div. 1, Groups B (16CX, 24CX, 26CX, and 84CX only), C and D; and Class II, Div. 1, Groups E, F and G
C	UL/CSA Rating: L59	Class I, Div. 1, Groups B (16CX, 24CX, 26CX, and 84CX only), C and D; and Class II, Groups E, F and G
D	UL/CSA Rating: L22	-25 °C to 85 °C (-13 °F to 185 °F) UL, CSA
F	UL/CSA Rating: L22	ATEX EExd IIC T6 Category II 2 GD Aluminium
G	Analog Current Output (4 mA to 20 mA)	80CX Bronze ¾ in - 14NPT Silver Gold

Switching options:

SPDT
Single Pole, Double Throw
Snap action contacts (1NC/1NO)

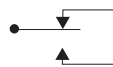

DPDT
Double Pole, Double Throw
Snap action contacts (2NC/2NO)

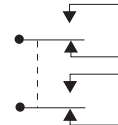

Analog position sensing specifications (Electrical rating "G")

Current output:	4 mA to 20 mA
Voltage compliance range:	12.5 Vdc to 40 Vdc
Maximum load resistance:	RL, Max., $\frac{-V \text{ Supply} - 12.5}{20 \text{ mA}}$
Current signal output:	4 mA to 20 mA
Span:	Adjustable from 15° to 90° of angular rotation
Null:	4 mA position may be set at any angular position

Operating characteristics

Basic Switch Type	BZ	BA	DT	HS
Pretravel (max.)*	15°	15°	30°	30°
Differential Travel (max.)	10°	10°	25°	20°
Overtravel (min.)*	90°	90°	75°	75°
Operating Torque (max.)	11.1 in lb/1,25 N m			

* May be modified in field to suit application requirements.

Note: Levers are ordered separately (see pages 71-73 for details)

Notes:

Add the letter "A" to listings with side mounting holes tapped 5/16 (8).

Example: 11CX2A

Add the letter "B" to listings with thru mounting holes tapped 3/8-24 (4).

Example: 11CX2B

Add the letter "C" to listings for low temperature (-40 °C/°F) applications.

Example: 11CX2C

Add "D01" to specify a "direct-couple" listing with 3/8 in. dia by 3/4 in. long flatted shaft.

Example: 11CX2-D01

Add the letter "E" to listings for European Atex approvals.

Example: 11CX2E

For Replacement Basic Switch Assemblies, change the first number in the listing to "9".

Example: 11CX2 becomes 91CX2

Short housing

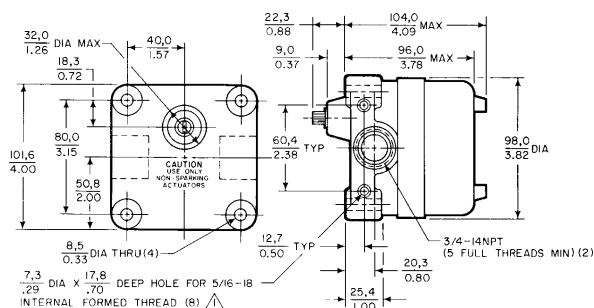

Standard housing

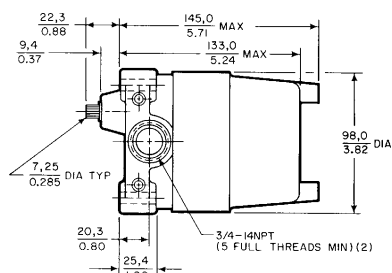

OPTIONS

HOUSING SIZE	BASIC SWITCHES	CONTACT	ELECTRICAL RATING	SHAFT RESTORING FORCE TO CENTRE	REFERENCE
Short	BZ (2)	SPDT	A	With	11CX2
Short	BZ (2)	SPDT	A	Without	11CX12
Short	BZ (2)	SPDT	A	With	11CX2E
Short	BZ (2)	SPDT	A	Without	11CX12E
Short	BZ (2)	SPDT	F	With	1172CX2
Short	BZ (2)	SPDT	F	Without	1172CX12
Standard	BZ (4)	SPDT	A	With	21CX4
Standard	BZ (4)	SPDT	A	Without	21CX14

UL listed for Class I, Group B (hydrogen atmospheres)

HOUSING SIZE	BASIC SWITCHES	CONTACT	ELECTRICAL RATING	SHAFT RESTORING FORCE TO CENTRE	REFERENCE
Standard	DT (2)	DPDT	C	With	24CX2
Standard	DT (2)	DPDT	C	Without	24CX12
Short	HS (2)	SPDT	D	With	16CX2
Short	HS (2)	SPDT	D	Without	16CX12
Standard	HS (4)	SPDT	D	With	26CX4

Analog output, 4 mA to 20 mA

HOUSING SIZE	BASIC SWITCHES	CONTACT	ELECTRICAL RATING	SHAFT RESTORING FORCE TO CENTRE	REFERENCE
Short	None	N/A	G	With	18CX0
Short	None	N/A	G	Without	18CX10
Short	None	N/A	G	Without	18CX10E
Standard	BZ (2)	SPDT	A, G	With	281CX2
Standard	BZ (2)	SPDT	A, G	Without	281CX12

Bronze housing for use in corrosive environments

80CX switches have rugged bronze housings which are resistant to salt water and other corrosive environments. They comply with the NEMA 4X requirement for protection against corrosion, in addition to NEMA enclosure standards met by other CX switches. O-ring seals make the enclosure weather-proof, but are outside of required flame paths, maintaining explosion-proof requirements.

HOUSING SIZE	BASIC SWITCHES	CONTACT	ELECTRICAL RATING	SHAFT RESTORING FORCE TO CENTRE	REFERENCE
Standard	BZ (2)	SPDT	A	With	81CX2
Standard	BZ (4)	SPDT	A	With	81CX4
Standard	BZ (4)	SPDT	A	Without	81CX14
Standard	DT (2)	DPDT	C	With	84CX2

LSX/BX Series Weather sealed explosion proof switches



LSX/BX Series weather sealed, explosion proof limit switches are for use either indoor or outdoors in hazardous atmospheres. They are completely sealed and designed for use in explosive gas/dust environments.

LSX/BX products meet the sealing standards of NEMA 1, 3, 4, 6, 7, 9 and 13. BX products are also sealed to IP67 standard and are ATEX approved (see specifications below).

All heads are field adjustable at 90° increments. Heads with side rotary actuators can be adjusted for clockwise and counter clockwise operation.

Actuators



Sealing:

LSX NEMA 1, 3, 4, 6, 7 (Class 1, Division 1, Groups B, C, D),
9 (Class 2, Division 1, Groups E, F, G), 13
BX IP67, NEMA 1, 3, 4, 6, 7 (Class 1, Division 1, Groups B, C, D),
9 (Class 2, Division 1, Groups E, F, G), 13

Approvals:

LSX/BX UL, CSA*
BX only EExd IIC T6 category II 2 GD, SIRA 00ATEX 1037X

Contacts:

Electrical ratings A, B Silver
Electrical rating C Gold

Switching options:

SPDT
Single Pole, Double Throw
Snap action contacts (1NC/1NO)

DPDT
Double Pole, Double Throw
Snap action contacts (2NC/2NO)

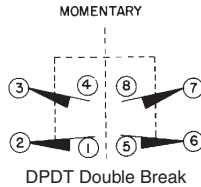
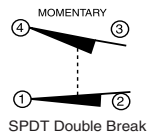

Rotary actuated switches

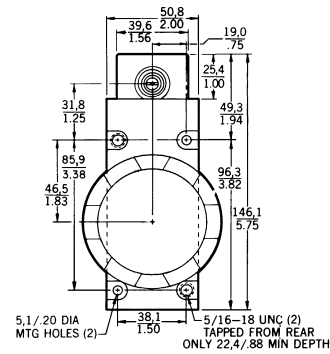

Operating torque max.:	Standard	0,45 N m (4.0 in lb)
	Low	0,19 Nm (1.7 in lb)
Pretravel max. (PT):	Standard	15°
	Low	9°
Overtravel min. (OT):	Standard	60°
	Low	66°
Differential travel max. (DT):	Standard SPDT	5°
	Standard DPDT	7°
	Low SPDT	3°
	Low DPDT	4°

* Applies only to listings with 1/2 in NPT or 3/4 in NPT

Electrical ratings

10 amps continuous carry. Circuits on any one pole must be the same polarity.

ac Volts

Pilot duty: 600 Vac, 720 VA

	Vac	Amps at 0.35 Power Factor	
		Make	Break
A	120	60	6
SPDT	240	30	3
NEMA	480	15	1.5
A600	600	12	1.2
B	120	30	3
DPDT	240	15	1.5
NEMA	480	7.5	0.75
B600	600	6	0.60
C	250 Vac or 60 Vdc, 0.050 amp max.		
SPDT/DPDT			

dc Volts

Pilot duty: 240 Vdc, 30 watts

	Vdc	Make and Break Amps	
		Inductive	Resistive
A	120	0.25	0.8
SPDT	240	0.15	0.4
B	120	0.25	0.8
DPDT	240	0.15	0.4
C	250 Vac or 60 Vdc, 0.050 amp max.		
SPDT/DPDT			

**Note: Levers are ordered separately
(see pages 71-73 for details)**

OPTIONS

Side rotary

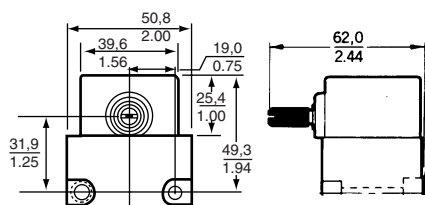

Maintained contact

Operating torque max.:	0,45 N m (4.0 in lb)
Pretravel max. (PT):	65°
Overtravel min. (OT):	20°
Differential travel max. (DT):	SPDT 30° DPDT 35°

LSX

Operating temperature: -1 °C to 121 °C (30 °F to 250 °F)

	CONTACT	CONDUIT	ELECTRICAL RATING	REFERENCE
Maintained	SPDT	½ in - 14NPT	A	LSXN3K
Maintained	DPDT	¾ in - 14NPT	B	LSXN4L
Maintained	DPDT	½ in - 14NPT	B	LSXN7L

LSX

Operating temperature: -12 °C to 121 °C (10 °F to 250 °F)

	CONTACT	CONDUIT	ELECTRICAL RATING	REFERENCE
	SPDT	½ in - 14NPT	A	LSXA3K
	SPDT	20 mm	A	LSX4A3K
	SPDT	¾ in - 14NPT	A	LSXA4K
	SPDT	½ in - 14NPT	C	LSXA3E
	DPDT	¾ in - 14NPT	B	LSXA4L
	DPDT	20 mm	B	LSX4A4L
	DPDT	½ in - 14NPT	B	LSXA7L
	SPDT	½ in - 14NPT	A	LSXP3K

Low DT

BX (ATEX approved)

Operating temperature: -40 °C to 70 °C [-40 °F to 158 °F]

	CONTACT	CONDUIT	ELECTRICAL RATING	REFERENCE
Maintained	SPDT	½ in - 14NPT	A	BXN3K
Maintained	DPDT	¾ in - 14NPT	B	BXN4L

BX (ATEX approved)

Operating temperature: -40 °C to 70 °C [-40 °F to 158 °F]

	CONTACT	CONDUIT	ELECTRICAL RATING	REFERENCE
	SPDT	½ in - 14NPT	A	BXA3K
	SPDT	20 mm	A	BX4A3K
	DPDT	¾ in - 14NPT	B	BXA4L

Top rotary

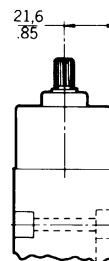

Operating torque max.:	0,28 N m (2.5 in lb)
Pretravel max. (PT):	25°
Overtravel min. (OT):	100°
Differential travel max. (DT):	SPDT 10° DPDT 12°

LSX

Operating temperature: -1 °C to 121 °C (30 °F to 250 °F)

	CONTACT	CONDUIT	ELECTRICAL RATING	REFERENCE
Low DT/Low torque	SPDT	½ in - 14NPT	A	LSXH3K
Low DT/Low torque	DPDT	¾ in - 14NPT	B	LSXH4L
Low torque	SPDT	½ in - 14NPT	A	LSXR3K
Low torque	DPDT	¾ in - 14NPT	B	LSXR4L

BX (ATEX approved)

Operating temperature: -40 °C to 70 °C [-40 °F to 158 °F]

	CONTACT	CONDUIT	ELECTRICAL RATING	REFERENCE
Low torque	SPDT	½ in - 14NPT	A	BXR3K
Low torque	SPDT	½ in - 14NPT	C	BXR3E
Low torque	DPDT	¾ in - 14NPT	C	BXR4S

LSX

Operating temperature: -1 °C to 121 °C (30 °F to 250 °F)

	CONTACT	CONDUIT	ELECTRICAL RATING	REFERENCE
	SPDT	½ in - 14NPT	A	LSXB3K
	DPDT	¾ in - 14NPT	B	LSXB4L

Centre neutral

Operating torque max. :	0,45 N m (4.0 in lb)
Pretravel max. (PT):	18°
Overtravel min. (OT):	57°
Differential travel max. (DT):	10°

LSX

Operating temperature: -1 °C to 121 °C (30 °F to 250 °F)

	CONTACT	CONDUIT	ELECTRICAL RATING	REFERENCE
	DPDT	¾ in - 14NPT	B	LSXM4N
	DPDT	20 mm	B	LSX4M4N

**LSX/BX Series (continued)
Plunger actuated switches**



Top plungers

Operating force max. (OF):	17,79 N (4 lb)
Pretravel max. (PT):	1,78 mm (0.07 in)
Overtravel min. (OT):	4,83 mm (0.19 in)
Differential travel max. (DT):	
SPDT	0,38 mm (0.015 in)
DPDT	0,51 mm (0.02 in)

OPTIONS

Top pin plunger

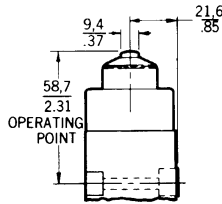

Operating point: 58,5 mm ± 0,76 mm (2.305 in ± 0.03 in)

LSX

Operating temperature: -12 °C to 93 °C (10 °F to 200 °F)

CONTACT	CONDUIT	ELECTRICAL RATING	REFERENCE
SPDT	½ in - 14NPT	A	LSXC3K
SPDT	20 mm	A	LSX4C3K
DPDT	¾ in - 14NPT	B	LSXC4L

BX (ATEX approved)

Operating temperature: -40 °C to 70 °C [-40 °F to 158 °F]

CONTACT	CONDUIT	ELECTRICAL RATING	REFERENCE
SPDT	20 mm	A	BX4C3K
DPDT	¾ in - 14NPT	B	BX4C4L
DPDT	20 mm	B	BX4C4L

Top roller plunger

Head can be set at 90° increments for cam or slide actuation

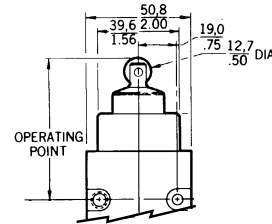

Operating point: 68,6 mm ± 1.00 mm (2.700 in ± 0.04 in)

LSX

Operating temperature: -12 °C to 93 °C (10 °F to 200 °F)

CONTACT	CONDUIT	ELECTRICAL RATING	REFERENCE
SPDT	½ in - 14NPT	A	LSXD3K
SPDT	20 mm	A	LSX4D3K
DPDT	¾ in - 14NPT	B	LSXD4L

BX (ATEX approved)

Operating temperature: -40 °C to 70 °C [-40 °F to 158 °F]

CONTACT	CONDUIT	ELECTRICAL RATING	REFERENCE
SPDT	20 mm	A	BX4D3K

Top pin plunger, adjustable

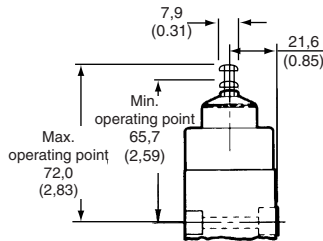

Operating point: 65,66 mm to 72,01 mm (2.585 in to 2.835 in)

LSX

Operating temperature: -12 °C to 93 °C (10 °F to 200 °F)

CONTACT	CONDUIT	ELECTRICAL RATING	REFERENCE
SPDT	½ in - 14NPT	A	LSXV3K

Wobble actuated switches

OPTIONS

Plastic rod

Side plungers

Operating force max. (OF): 26,69 N (6 lb)
 Pretravel max. (PT): 2,54 mm (0.10 in)
 Overtravel min. (OT): 4,83 mm (0.19 in)
 Differential travel max. (DT): 1,14 mm (0.045)

OPTIONS

Side pin plunger

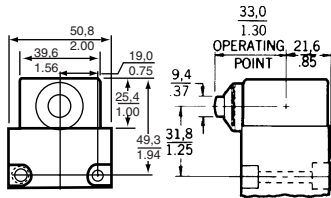

Operating point: 33,0 mm (1.30 in)

LSX

Operating temperature: -12 °C to 93 °C (10 °F to 200 °F)

CONTACT	CONDUIT	ELECTRICAL RATING	REFERENCE
SPDT	½ in - 14NPT	A	LSXE3K
DPDT	¾ in - 14NPT	B	LSXE4L

Side roller plunger

Roller may be set in vertical or horizontal position for cam or slide actuation

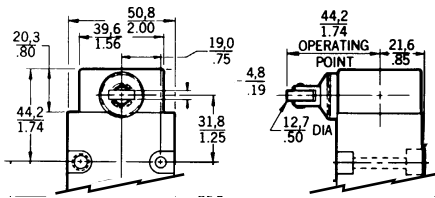

Operating point: 44,1 mm (1.735 in)

LSX

Operating temperature: -12 °C to 93 °C (10 °F to 200 °F)

CONTACT	CONDUIT	ELECTRICAL RATING	REFERENCE
SPDT	½ in - 14NPT	A	LSXF3K

BX (ATEX approved)

Operating temperature: -40 °C to 70 °C [-40 °F to 158 °F]

CONTACT	CONDUIT	ELECTRICAL RATING	REFERENCE
SPDT	½ in - 14NPT	A	BXF3K

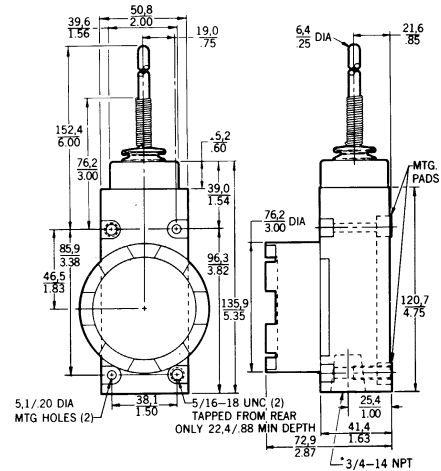

Operating force max. (OF): 2,78 N (10 oz)
 Pretravel max. (PT): 25,4 mm (1.0 in)

LSX

Operating temperature: -12 °C to 93 °C (10 °F to 200 °F)

CONTACT	CONDUIT	ELECTRICAL RATING	REFERENCE
SPDT	½ in - 14NPT	A	LSXJ3K-7A
DPDT	¾ in - 14NPT	B	LSXJ4L-7A

Cat whisker

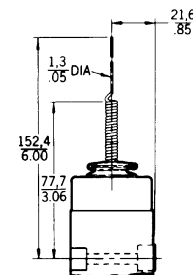

Operating force max. (OF): 1,39 N (5 oz)
 Pretravel max. (PT): 50,8 mm (2.0 in)

LSX

Operating temperature: -12 °C to 93 °C (10 °F to 200 °F)

CONTACT	CONDUIT	ELECTRICAL RATING	REFERENCE
SPDT	½ in - 14NPT	A	LSXK3K-8A

Levers

Separate levers must be ordered with side rotary types. The table provides a cross reference between product families and the lever order/reference numbers. The following pages describe the levers. Illustrations are for reference only. Exact mounting drawings and dimensions are available from your local sales office or from the website below.

Levers lock in any position, 360° around the shaft. Rollers may be mounted on the front or back of the lever.

All levers are supplied with cap screws.

Explosion proof switches

Because of explosion proof requirements, only nylon rollers or other non sparking material should be selected. BX/LSX, CX and EX plunger and cat whisker types are of non sparking material. **Do not mix or substitute.**

Specification (unless stated otherwise)

Lever radius/length: 1.5 in (38,1 mm)
Roller Diameter: 0.75 in (19,1 mm)
Roller Width: 0.25 in (6,35 mm)
 -EX 0.312 in (7,92 mm)

Note:

Not all levers are compatible with all switches

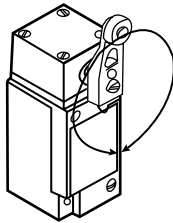

FRONT MOUNT

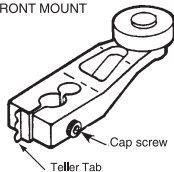

BACK MOUNT

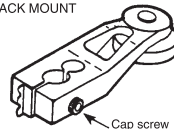

REFERENCE	ROLLER MATERIAL	LIMIT SWITCH SERIES				EXPLOSION PROOF SERIES		
		GLA	HDLS	LS2	LS	BX/LSX	CX	EX
6PA57	Aluminium				❖			
6PA63	Stainless steel				❖			
6PA69	Spring rod				❖			
6PA80	Steel				❖			
6PA82	Steel				❖			
6PA102	Nylon				❖			
6PA144	Ball bearing				❖			
GLZ51A	Nylon	❖						
GLZ51B	Steel	❖						
GLZ52A	Nylon	❖						
GLZ52B	Steel	❖						
GLZ54J	Aluminium	❖						
GLZ55B	Steel	❖						
LSZ51	N/A		❖			❖	❖	
LSZ51A	Nylon		❖		❖	❖	❖	
LSZ51B	Steel		❖		❖			
LSZ51C	Nylon		❖			❖	❖	
LSZ51D	Steel		❖					
LSZ51W	Rubber		❖					
LSZ51Y	Rubber		❖					
LSZ52	N/A		❖					
LSZ52A	Nylon		❖			❖		
LSZ52B	Steel		❖					
LSZ52C	Nylon		❖		❖	❖	❖	
LSZ52D	Steel		❖		❖			
LSZ52J	Nylon		❖		❖	❖	❖	
LSZ52K	Nylon		❖		❖	❖	❖	
LSZ52M	Nylon		❖		❖	❖		
LSZ52N	Nylon		❖			❖		
LSZ52W	Rubber		❖					
LSZ52Y	Rubber		❖					
LSZ53A	Nylon		❖					
LSZ53B	Steel		❖					
LSZ53D	Steel		❖					
LSZ53E	Nylon		❖			❖	❖	
LSZ53P	Steel		❖					
LSZ53S	Nylon		❖			❖	❖	
LSZ53U	Steel		❖					
LSZ54	N/A		❖			❖	❖	
LSZ54M	Aluminium		❖		❖	❖	❖	
LSZ54N	Stainless steel		❖					
LSZ54R	Spring wire		❖					
LSZ54V	Cable		❖					
LSZ55	N/A		❖			❖	❖	
LSZ55A	Nylon		❖			❖	❖	
LSZ55B	Steel		❖					
LSZ55C	Nylon		❖			❖		
LSZ55D	Steel		❖					
LSZ55W	Rubber		❖					
LSZ55Y	Rubber		❖					
LSZ61	Nylatron		❖					
LSZ67AA	Rubber		❖					
LSZ68	Delrin		❖					
6PA5-EX	Bronze							❖
6PA127-EX	Nylon							❖
6PA130-EX	Bronze							❖
6PA131-EX	Bronze							❖
6PA136-EX	Aluminium							❖
6PA138-EX	Nylon							❖
6PA142-EX	Bronze							❖
6PA204-EX	Nylon							❖
Stainless steel levers								
LS2Z51A	Nylon		❖	❖			❖	
LS2Z51B	Steel		❖	❖				
LS2Z52A	Nylon		❖	❖			❖	
LS2Z52B	Steel		❖	❖				
LS2Z54N	Steel		❖	❖				

OPTIONS * denotes lever suitable for Explosion Proof Series switches

Standard fixed lever

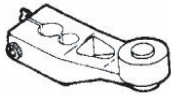

	MOUNTED ON	REFERENCE
Without roller		LSZ51*
Nylon roller	Front	LSZ51A*
Metal roller	Front	LSZ51B
Nylon roller	Back	LSZ51C*
Metal roller	Back	LSZ51D
Nylon roller	Front	GLZ51A
Metal roller	Front	GLZ51B
Bronze roller	Front	6PA5-EX*
Nylon roller	Front	6PA127-EX*
Ball bearing roller	Front	6PA144

Offset fixed lever



	MOUNTED ON	REFERENCE
Without roller		LSZ55*
Nylon roller	Back	LSZ55A*
Metal roller	Back	LSZ55B
Nylon roller	Front	LSZ55C*
Metal roller	Front	LSZ55D
Metal roller	Front	GLZ55B

Adjustable lever

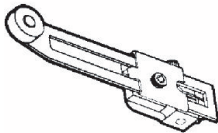

Operating radius/length: 1.5 in to 3.5 in (38,1 mm to 88,9 mm)
 -EX 1.69 in to 3.0 in (42,9 mm to 76,2 mm)

	MOUNTED ON	REFERENCE
Adjustable lever, without roller		LSZ52
Nylon roller	Back	LSZ52A*
Metal roller	Back	LSZ52B
Nylon roller	Front	LSZ52C*
Metal roller	Front	LSZ52D
Nylon roller, Ø 1.0 in (25,4) x 0.5 in (12,7 mm)	Front	LSZ52J*
Nylon roller, Ø 1.5 in (38,1)	Front	LSZ52K*
Nylon roller, Ø 2.0 in (50,8)	Front	LSZ52M*
Nylon roller, 0.5 in wide (12,7 mm)	Front	LSZ52N*
Nylon roller	Back	GLZ52A
Metal roller	Back	GLZ52B
Nylon roller, Ø 1.0 in (25,4) x 0.5 in (12,7 mm)	Front	6PA138-EX*

One way roller lever

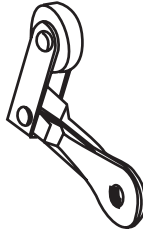

	RADIUS/LENGTH	REFERENCE
Bronze roller, clockwise	1.56 in (39,6 mm)	6PA130-EX*
Bronze roller, counter clockwise	1.56 in (39,6 mm)	6PA142-EX*

Perpendicular (cross) roller lever



	RADIUS/LENGTH	REFERENCE
Bronze roller	1.81 in (46,0 mm)	6PA131-EX*

Yoke lever

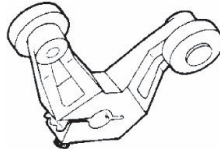

	MOUNTED ON	REFERENCE
Nylon roller	Front/Back	LSZ53A
Metal roller	Front/Back	LSZ53B
Metal roller	Front/Front	LSZ53D
Nylon roller	Back/Front	LSZ53E*
Metal roller	Back/Back	LSZ53P
Nylon roller	Back/Back	LSZ53S*
Metal roller	Back/Front	LSZ53U
Metal roller	Front/Back	6PA80
Metal roller	Front/Front	6PA82
Nylon roller	Front/Front	6PA102

Adjustable rod

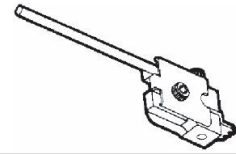

	RADIUS/LENGTH	REFERENCE
Hub only		LSZ54*
Aluminium rod	5.5 in (139,7 mm)	LSZ54M*
Stainless steel rod	13.0 in (330,2 mm)	LSZ54N
Aluminium, spring only	12.0 in (305 mm)	LSZ54R
Aluminium, flexible cable	4.8 in (122 mm)	LSZ54V
Aluminium rod	7.9 in (200 mm)	GLZ54J
Stainless steel rod	13.0 in (330,2 mm)	6PA63
Aluminium rod	5.3 in (134,1 mm)	6PA136-EX*

Adjustable rod, nylon roller

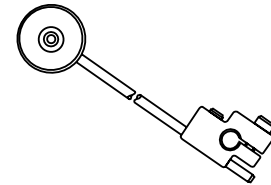

	RADIUS/LENGTH	REFERENCE
Aluminium rod, nylon roller	12.5 in (317,5 mm)	6PA204-EX*

Spring rod

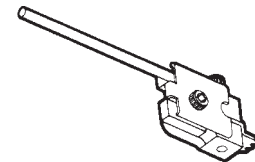

	RADIUS/LENGTH	REFERENCE
Ø 0.25 in (6,35 mm)	12.0 in (305 mm)	LSZ68
Ø 0.17 in (4,32 mm)	7.4 in (188 mm)	6PA69

Note: Not all levers are compatible with all switches

** denotes lever suitable for Explosion Proof Series switches*

Flexible loop

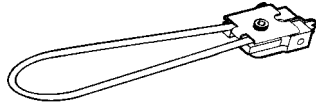

	RADIUS/LENGTH	REFERENCE
Flexible loop	6.0 in (152 mm)	LSZ61

Hand operated button

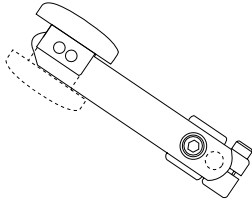

	REFERENCE
Ø 1.5 in (38,1 mm)	6PA57

****Large rubber roller, fixed lever**

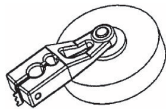

	REFERENCE
Ø 1.6 in X 0.50 in wide roller (40,6 mm X 12,7 mm)	LSZ51W
Ø 2 in X 0.50 in wide roller (50,8 mm X 12,7 mm)	LSZ51Y

****Large rubber roller, fixed offset lever**

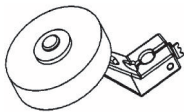

	REFERENCE
Ø 1.6 in X 0.50 in wide roller (40,6 mm X 12,7 mm)	LSZ55W
Ø 2 in X 0.50 in wide roller (50,8 mm X 12,7 mm)	LSZ55Y

****Large rubber roller, adjustable lever**

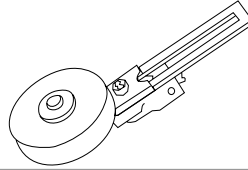

	REFERENCE
Ø 1.6 in X 0.50 in wide roller (40,6 mm X 12,7 mm)	LSZ52W
Ø 2 in X 0.50 in wide roller (50,8 mm X 12,7 mm)	LSZ52Y

****Conveyor roller arm**

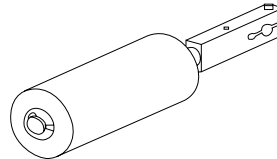

Operating radius/length: 6.78 in (172,2 mm)

	REFERENCE
Plastic roller, 1.5 in Ø X 3.8 in long (38,1 mm X 96,5 mm)	LSZ67AA

NOTICE **

Large rubber rollers and conveyor roller arm
Because of the lever's mass, the limit switch should be mounted with the lever facing down. This will enable gravity to help restore the switch to the free position.

Stainless steel levers

Roller Diameter:	0.75 in (19,1 mm)
Roller Width:	0.25 in (6,35 mm)

OPTIONS

Standard fixed lever

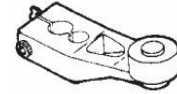

Operating radius/length: 1.5 in (38,1 mm)

	MOUNTED ON	REFERENCE
Nylon roller	Front	LSZ251A*
Stainless steel roller	Front	LSZ251B

Adjustable lever

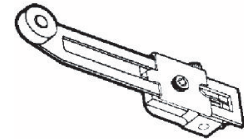

Operating radius/length: 1.5 in to 3.5 in (38,1 mm to 88,9 mm)

	MOUNTED ON	REFERENCE
Nylon roller	Back	LSZ252A*
Stainless steel roller	Back	LSZ252B

Adjustable rod

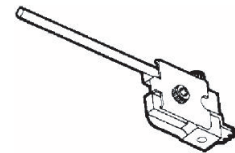

Operating radius/length: 13 in (330,2 mm)

	REFERENCE
	LSZ254N

Note: Not all levers are compatible with all switches

SZR-MY Series Power Relay



SZR-MY Series general-purpose power relays are designed for a wide range of applications including power, as well as logic control, for factory machines and control panels.

SZR-MY Series relays have a small package design for multiple application needs. Relays are available in two configurations: DPDT with a 5 A load and 4PDT with a 3 A load. One standard and three options are available: LED indicator, internal surge protection diode, and LED indicator/diode protection.

Current rating (SZR-MY2):	5 A
Current rating (SZR-MY4):	3 A
Contact resistance:	50 mOhm max.
Contact material:	Fine silver
Agency approvals:	UL, CE, CSA
Operate time:	20 ms max.
Release time:	20 ms max.
Ambient temperature:	-25 °C to 75 °C (-13 °F to 167 °F)
Ambient humidity:	45% RH to 85% RH
Switching options:	DPDT, 4PDT

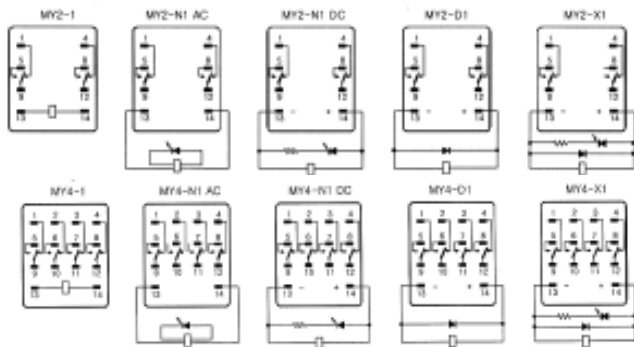

MY2 Series

OPTIONS

Standard, PCB Terminal, DPDT

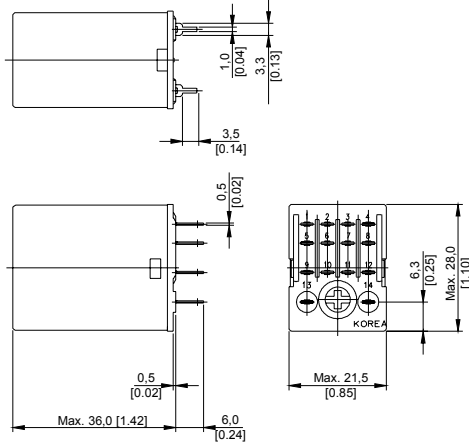

COIL INPUT VOLTAGE	MAX. CONTACT RATING	REFERENCE
110/120 Vac	250 Vac/5 amp	SZR-MY2-1P-AC110-120V
220/240 Vac	250 Vac/5 amp	SZR-MY2-1P-AC220V-240V
24 Vdc	125 Vdc/1 amp	SZR-MY2-1P-DC24V

Solder/Plug-In Terminal, DPDT

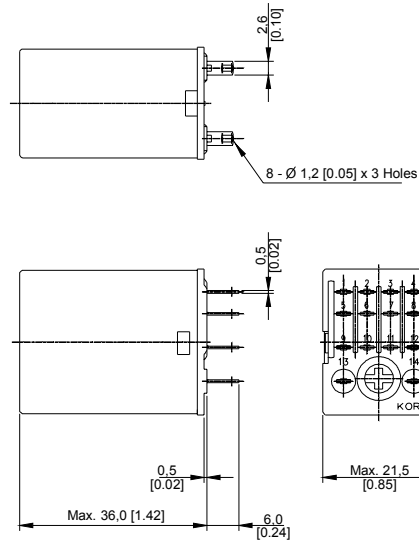

Standard

COIL INPUT VOLTAGE	MAX. CONTACT RATING	REFERENCE
110/120 Vac	250 Vac/5 amp	SZR-MY2-1-AC110-120V
220 Vac	250 Vac/5 amp	SZR-MY2-1-AC220V
12 Vdc	125 Vdc/1 amp	SZR-MY2-1-DC12V
24 Vdc	125 Vdc/1 amp	SZR-MY2-1-DC24V

LED Indicator

COIL INPUT VOLTAGE	MAX. CONTACT RATING	REFERENCE
110/120 Vac	250 Vac/5 amp	SZR-MY2-N1-AC110-120V
220 Vac	250 Vac/5 amp	SZR-MY2-N1-AC220V
12 Vdc	125 Vdc/1 amp	SZR-MY2-N1-DC12V
24 Vdc	125 Vdc/1 amp	SZR-MY2-N1-DC24V

Diode Protection

COIL INPUT VOLTAGE	MAX. CONTACT RATING	REFERENCE
24 Vdc	125 Vdc/1 amp	SZR-MY2-D1-DC24V

LED Indicator/Diode Protection

COIL INPUT VOLTAGE	MAX. CONTACT RATING	REFERENCE
24 Vdc	125 Vdc/1 amp	SZR-MY2-X1-DC24V

MY4 Series

OPTIONS

Standard, PCB Terminal, 4PDT

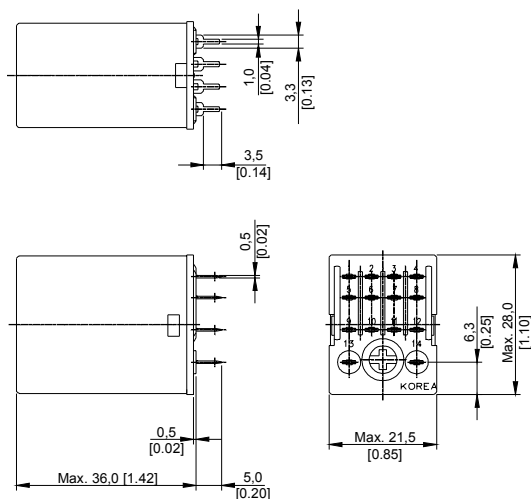

COIL INPUT VOLTAGE	MAX. CONTACT RATING	REFERENCE
110/120 Vac	250 Vac/3 amp	SZR-MY4-1P-AC110-120V
220/240 Vac	250 Vac/3 amp	SZR-MY4-1P-AC220V-240V
24 Vdc	125 Vdc/0.6 amp	SZR-MY4-1P-DC24V

Solder/Plug-In Terminal, 4PDT

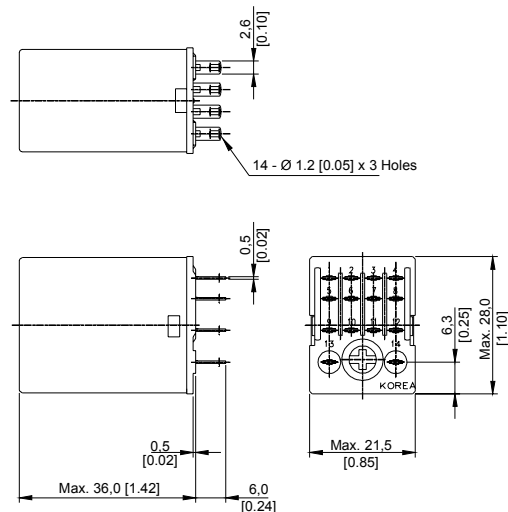

Standard

COIL INPUT VOLTAGE	MAX. CONTACT RATING	REFERENCE
110/120 Vac	250 Vac/3 amp	SZR-MY4-1-AC110-120V
220 Vac	250 Vac/3 amp	SZR-MY4-1-AC220V
12 Vdc	125 Vdc/0.6 amp	SZR-MY4-1-DC12V
24 Vdc	125 Vdc/0.6 amp	SZR-MY4-1-DC24V

LED Indicator

COIL INPUT VOLTAGE	MAX. CONTACT RATING	REFERENCE
110/120 Vac	250 Vac/3 amp	SZR-MY4-N1-AC110-120V
220 Vac	250 Vac/3 amp	SZR-MY4-N1-AC220V
12 Vdc	125 Vdc/0.6 amp	SZR-MY4-N1-DC12V
24 Vdc	125 Vdc/0.6 amp	SZR-MY4-N1-DC24V

Diode Protection

COIL INPUT VOLTAGE	MAX. CONTACT RATING	REFERENCE
24 Vdc	125 Vdc/0.6 amp	SZR-MY4-D1-DC24V

LED Indicator/Diode Protection

COIL INPUT VOLTAGE	MAX. CONTACT RATING	REFERENCE
24 Vdc	125 Vdc/0.6 amp	SZR-MY4-X1-DC24V

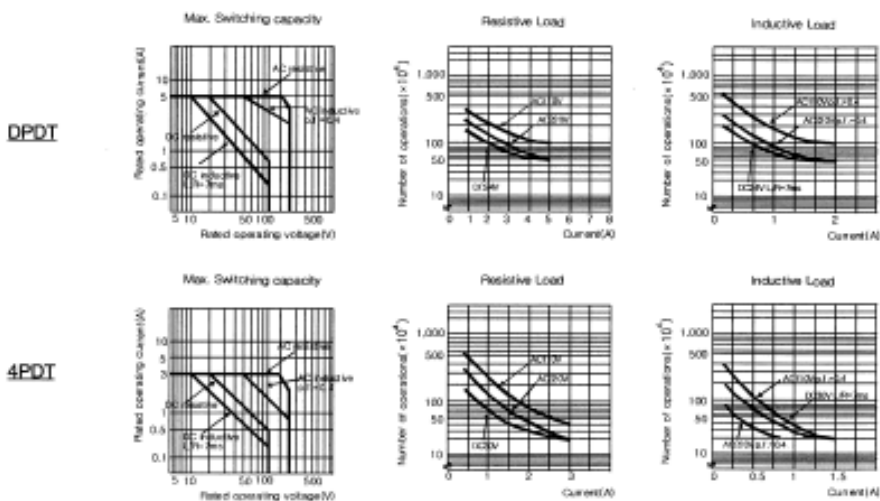

SZR-LY Series Power Relay



SZR-LY Series general-purpose power relays are designed for a wide range of applications including power, as well as logic control, for factory machines and control panels.

SZR-LY Series relays break 10 A loads are ideal for control panels that require stable and reliable relays.

One standard and three options are available: LED indicator, internal surge protection diode, and LED indicator/diode protection.

- Current rating:** 10 A
- Contact resistance:** 50 mOhm max.
- Contact material:** Silver cadmium oxide
- Agency approvals:** UL, CE, CSA
- Operating frequency:** 18,000 operations/hour (mechanical)
1,800 operations/hour (electrical)
- Operate time:** 25 ms max.
- Release time:** 25 ms max.
- Ambient temperature:** -25 °C to 70 °C (-13 °F to 158 °F)
- Ambient humidity:** 45% RH to 85% RH
- Switching options:** DPDT, 4PDT

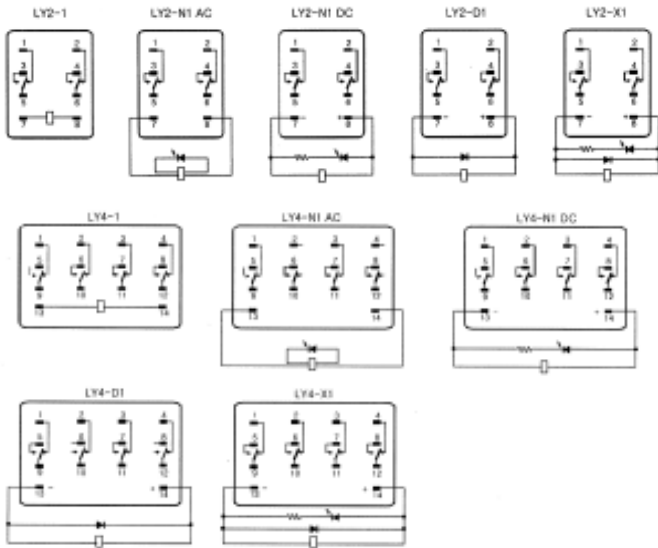

LY2 Series

OPTIONS

Standard, PCB Terminal, DPDT

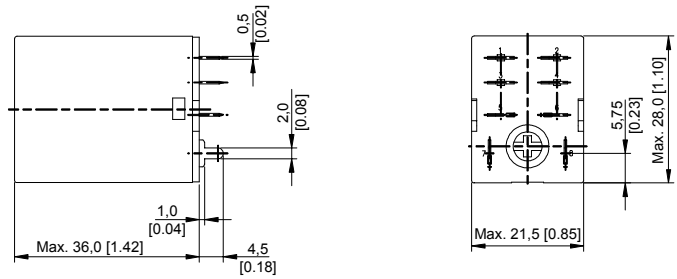

COIL INPUT VOLTAGE	MAX. CONTACT RATING	REFERENCE
110/120 Vac	250 Vac/10 amp	SZR-LY2-1P-AC110-120V
24 Vdc	125 Vdc/2 amp	SZR-LY2-1P-DC24V

Solder/Plug-In Terminal, DPDT

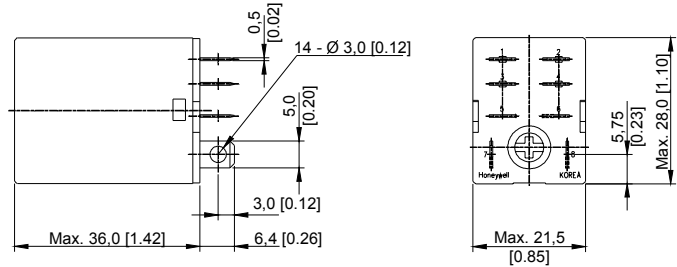

Standard

COIL INPUT VOLTAGE	MAX. CONTACT RATING	REFERENCE
110/120 Vac	250 Vac/10 amp	SZR-LY2-1-AC110-120V
220 Vac	250 Vac/10 amp	SZR-LY2-1-AC220V
12 Vdc	125 Vdc/2 amp	SZR-LY2-1-DC12V
24 Vdc	125 Vdc/2 amp	SZR-LY2-1-DC24V

LED Indicator

COIL INPUT VOLTAGE	MAX. CONTACT RATING	REFERENCE
110/120 Vac	250 Vac/10 amp	SZR-LY2-N1-AC110-120V
220 Vac	250 Vac/10 amp	SZR-LY2-N1-AC220V
12 Vdc	125 Vdc/2 amp	SZR-LY2-N1-DC12V
24 Vdc	125 Vdc/2 amp	SZR-LY2-N1-DC24V

Diode Protection

COIL INPUT VOLTAGE	MAX. CONTACT RATING	REFERENCE
24 Vdc	125 Vdc/2 amp	SZR-LY2-D1-DC24V

LED Indicator/Diode Protection

COIL INPUT VOLTAGE	MAX. CONTACT RATING	REFERENCE
24 Vdc	125 Vdc/ 2 amp	SZR-LY2-X1-DC24V

LY4 Series

OPTIONS

Standard, PCB Terminal, 4PDT

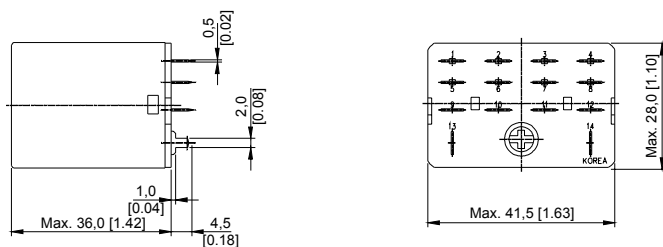

COIL INPUT VOLTAGE	MAX. CONTACT RATING	REFERENCE
110/120 Vac	250 Vac/10 amp	SZR-LY4-1P-AC110-120V
220/240 Vac	250 Vac/10 amp	SZR-LY4-1P-AC220V-240V
24 Vdc	125 Vdc/2 amp	SZR-LY4-1P-DC24V

Solder/Plug-In Terminal, 4PDT

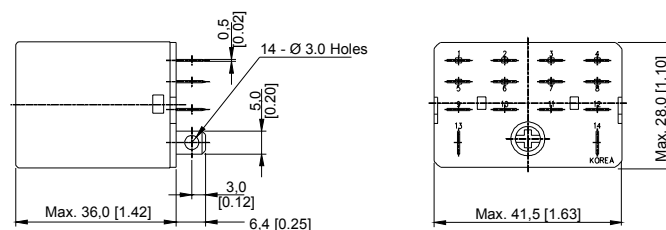

Standard

COIL INPUT VOLTAGE	MAX. CONTACT RATING	REFERENCE
110/120 Vac	250 Vac/10 amp	SZR-LY4-1-AC110-120V
220 Vac	250 Vac/10 amp	SZR-LY4-1-AC220V
12 Vdc	125 Vdc/2 amp	SZR-LY4-1-DC12V
24 Vdc	125 Vdc/2 amp	SZR-LY4-1-DC24V

LED Indicator

COIL INPUT VOLTAGE	MAX. CONTACT RATING	REFERENCE
110/120 Vac	250 Vac/10 amp	SZR-LY4-N1-AC110-120V
220 Vac	250 Vac/10 amp	SZR-LY4-N1-AC220V
12 Vdc	125 Vdc/2 amp	SZR-LY4-N1-DC12V
24 Vdc	125 Vdc/2 amp	SZR-LY4-N1-DC24V

Diode Protection

COIL INPUT VOLTAGE	MAX. CONTACT RATING	REFERENCE
24 Vdc	125 Vdc/2 amp	SZR-LY4-D1-DC24V

LED Indicator/Diode Protection

COIL INPUT VOLTAGE	MAX. CONTACT RATING	REFERENCE
24 Vdc	125 Vdc/2 amp	SZR-LY4-X1-DC24V

DPDT

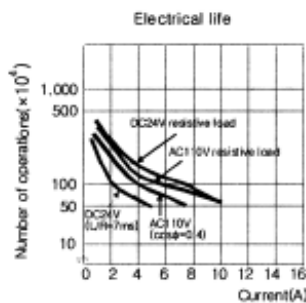
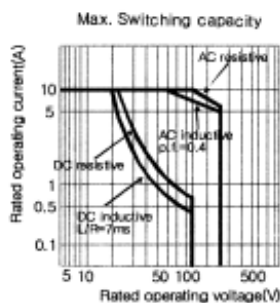

4PDT

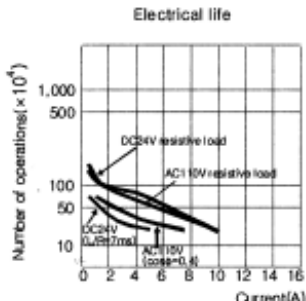
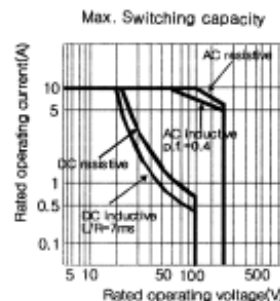

MY2 Series Socket

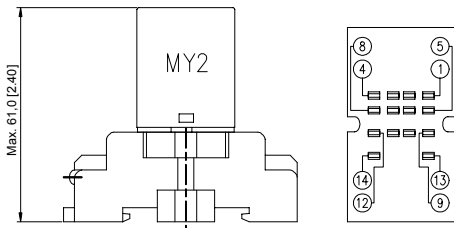
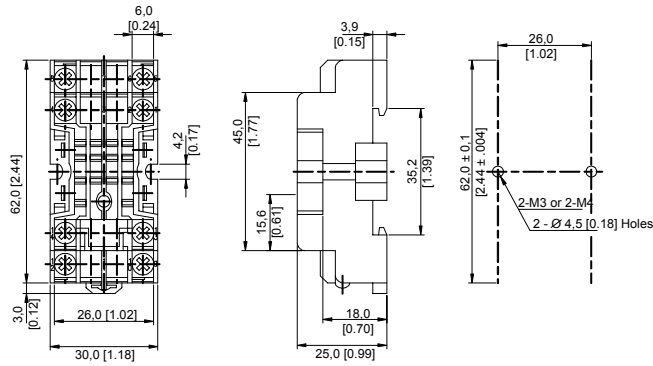

TYPE	POLES	REFERENCE
Rail socket	2	SZX-SMF-08N

LY2 Series Socket

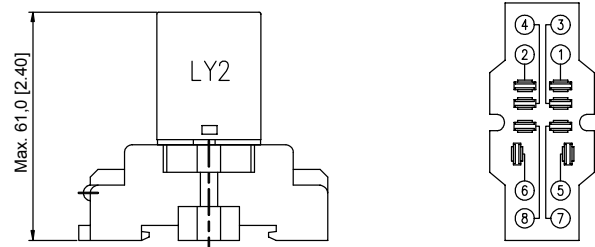
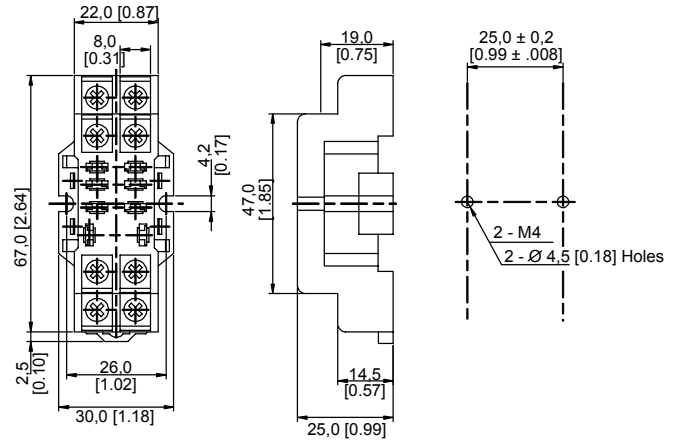

TYPE	POLES	REFERENCE
Rail socket	2	SZX-SLF-08N

MY4 Series Socket

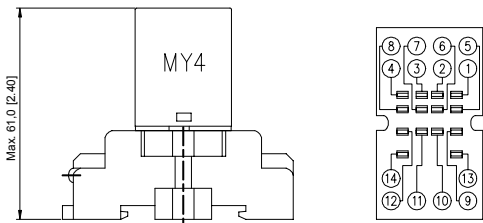
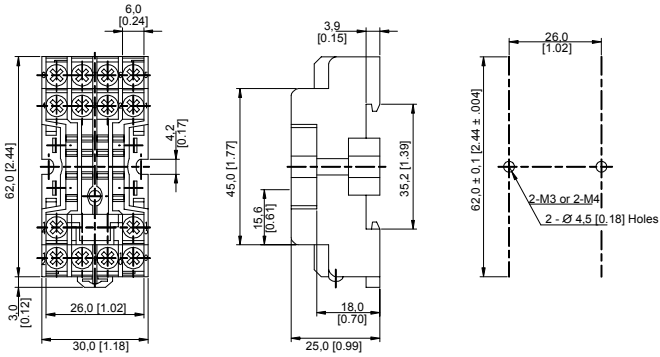

TYPE	POLES	REFERENCE
Rail socket	4	SZX-SMF-14N

LY4 Series Socket

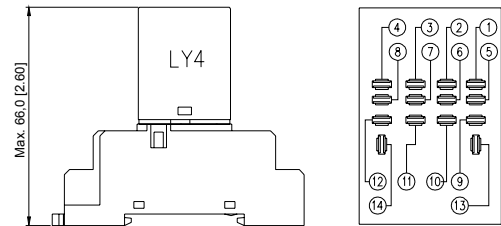
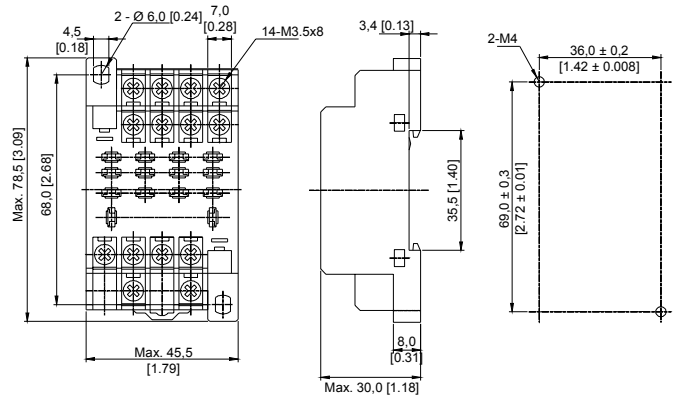

TYPE	POLES	REFERENCE
Rail socket	4	SZX-SLF-14

Electromechanical Safety Switches

Honeywell is a worldwide leader in advanced switching and sensing technology - especially in the area of industrial safety. We offer both electromechanical safety switches and electronic safety sensors as well as safety control modules for safety applications in all categories of risk. Customers can count on our diverse product line to meet all of their machine safety applications.

Honeywell products meet or exceed European machine safety standards and have been approved (CE, BG, INRS) for use in Europe for more than 25 years. As North America moves toward harmonizing with global standards, machine builders and users can confidently turn to Honeywell for compliant machine safety solutions. Our products are designed to meet all applicable OSHA and ANSI standards.

Refer to pages 8 and 9 for more information about degrees of protection and electrical ratings.

Protective Guarding

Protective guarding around a dangerous machine can be achieved with tamper-resistant safety switches. Safety switches incorporate positive opening operation such that even a welded contact will be mechanically broken and a stop signaled. These switches monitor the position of moveable guards and doors, which are used to safeguard access to equipment and provide protection from ejected pieces, chips, projectiles or oil. These safeguards require a relatively low investment and provide reliable protection if they are regularly checked and maintained.



Cable Pull Switches

Cable-pull limit switches serve as a readily accessible means of emergency stop for applications. These cable-pull devices are visible, accessible and easy to use and they immediately open the emergency stop circuit when activated.

⚠ WARNING **IMPROPER INSTALLATION**

- Consult with local safety agencies and their requirements when designing a machine-control link, interface and all control elements that affect safety.
- Strictly adhere to all installation instructions.

Failure to comply with these instructions could result in death or serious injury.

Selection Guide for Electromechanical Safety Switches

Series	Housing Material		Approvals				Sealing		Dimensions HeightxWidthxDepth mm (in)	Actuator	Electrical Rating	Operating Temperature	
	Plastic	Metal	BG	CE	UL	CSA	IEC IP	NEMA (USA)				From	To
											°C (°F)		
GKM	•		•	•	•	•	67	1, 12, 13	69,4 x 34,0 x 16,0 (2.73 x 1.34 x 0.63)	Straight or 90° key	AC15, DC13 A300	-25 (-13)	85 (185)
GSS	GSC	•	•	•	•	•	66	1, 4, 12, 13	83,0 x 30,5 x 30,0 (3.27 x 1.2 x 1.18)	Hinge Straight or 90°	AC15, DC13 A300	-25 (-13)	85 (185)
	GSD	•	•	•	•	•	66	1, 12, 13			AC15, DC13 A600		
	GSE	•	•	•	•	•	66	1, 4, 12, 13			AC15, DC13 A300		
GK		•	•	•	•	•	67	1, 4, 12, 13	121,6 x 42,0 x 42,6 (4.79 x 1.65 x 1.68)	Straight, 90°, Spring key	AC15, DC13 A600	-25 (-13)	85 (185)
GK/L/R		•	•	•	•	•	67	1, 4, 6P, 12, 13	149,0 x 110,0 x 48,8 (5.85 x 4.33 x 1.92)	Straight, 90°, Spring key	AC15, DC13 A600	-25 (-13)	85 (185)
1CPS		•	•	•	•	•	67	1, 4, 12, 13	99,1 x 276,2 x 65,2 (3.9 x 10.87 x 2.57)	Linear	AC15, DC13 A600	-25 (-13)	85 (185)
2CPS		•	•	•	•	•	67	1, 4, 12, 13	165,1 x 325,9 x 79,8 (6.5 x 12.75 x 3.14)	Left and/or Right	AC15, DC13 A600	-40 (-40)	85 (185)



Honeywell

www.honeywell.com/sensing

	Switching Options												Termination	Special Features	Page Number	
	Snap Action				Slow Action						Gold Contacts (Low Energy Options)					
	1NC/1NO	2NC/2NO	1NC/1NO	2NC/2NO	1NC	2NC	Make Before Break	Break Before Make								
1NC/1NO	2NC/2NO	1NC/1NO	2NC/2NO	1NC	2NC	1NC/1NO	1NC/1NO	2NC/1NO	2NC/2NO	3NC/1NO	4NC					
						•		•					•	M12 or Cable	Daisy chain capability	82
		•				•		•	•	•	•	•	•	Conduit		85
		•				•		•					•			85
		•				•		•	•	•	•	•	•			86
		•	•			•		•	•	•	•	•	•	Conduit		87
		•	•			•		•	•	•	•	•	•	Conduit		89
								•	•	•	•	•	•	Conduit	Integral LED option	93
									•	•			Standard	Conduit	High intensity multi-cluster LED	95



GKM Series Global Miniature Safety Key Operated Switch

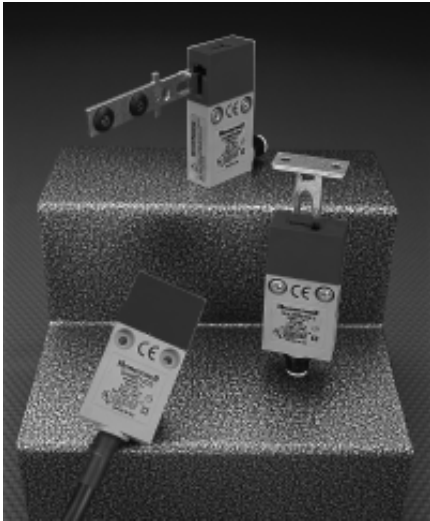

Used alone as Category 1 safety components or, in conjunction with other safety switches and our complete range of safety relays, it is possible to construct comprehensive protection schemes with Category 2, 3 or 4 compliance.

The prelead versions allow rapid fit, easy cable routing and function testing which cut costs dramatically in OEM applications. Simple upgrade guarding solution for End User applications.

Low energy basic switches are rated as follows:

Operating Voltage U_e 1 Vdc to 60 Vdc or 1 Vac to 125 Vac

Operating Current I_e 1 mA to 50 mA

Example of catalog listing using a low energy basic switch - GKMA19

Mechanical life: > 1 million
Sealing: IP66/67, EN 60529, NEMA 1, 12, 13
Operating temperature: -25 °C to 85 °C (-13 °F to 185 °F)
Approvals: CE, UL, CSA
 AC15 B300
 DC13 Q300

Contacts:

Low energy Silver
 Gold plated Slow action contacts

Switching options:

1 Normally Closed/1 Normally Open, Break Before Make
 1NC/1NO, BBM - GKMF
 1 Normally Closed, Break Before Make
 1NC/1NO, BBM, low energy - GKMA, B, C, D

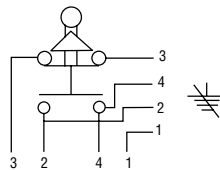

2NC - GKMF

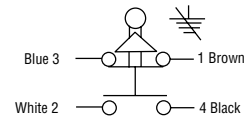

2 Normally Closed
 2NC, low energy - GKMA, B, C, D

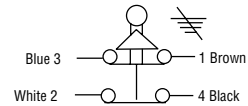
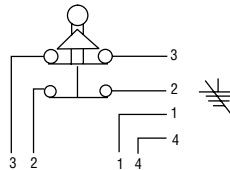

Electrical ratings:

Designation & Utilization Category	IEC 60947-5-1/EN 60947-5-1						VA rating	
	Rated operational current I_e (A) at rated operational voltage U_e						Make	Break
	120 V	240 V	380 V	480 V	500 V	600 V		
AC15 A600	6	3	1,9	1,5	1,4	1,2	7200	720
AC15 A300	6	3	-	-	-	-	7200	720
AC15 B300	3	1,5	-	-	-	-	3600	360
AC14 D300	0,6	0,3	-	-	-	-	432	72
	125 V 250 V							
DC13 Q300	0,55	0,27					69	69
DC13 R300	0,22	0,1					28	28

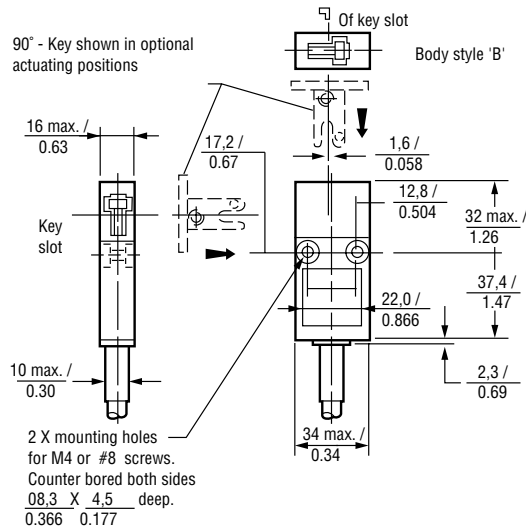

OPTIONS

Side exit cable

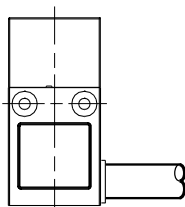

CABLE LENGTH	CONTACT	REFERENCE
1 m	2NC, low energy	GKMA17
1 m	1NC/1NO, BBM, low energy	GKMA19
2 m	1NC/1NO, BBM	GKMA23
2 m	2NC	GKMA26
2 m	2NC, low energy	GKMA27
2 m	1NC/1NO, BBM, low energy	GKMA29
3 m	1NC/1NO, BBM	GKMA33
3 m	2NC	GKMA36
3 m	2NC, low energy	GKMA37
3 m	1NC/1NO, BBM, low energy	GKMA39

Side exit M12 dc micro-change connector

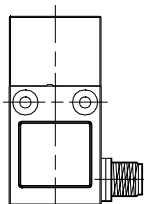

CONTACT	REFERENCE
1NC/1NO, BBM	GKMC03
2NC	GKMC06
2NC, low energy	GKMC07
1NC/1NO, BBM, low energy	GKMC09

Bottom exit M12 dc micro-change connector

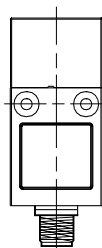

CONTACT	REFERENCE
1NC/1NO, BBM	GKMD03
2NC, low energy	GKMD07
1NC/1NO, BBM, low energy	GKMD09

Dual exit M12 dc micro-change connector

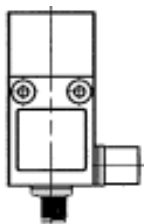

CONTACT	REFERENCE
1NC/1NO, BBM	GKMF03
2NC	GKMF06
2NC, low energy	GKMF07
1NC/1NO, BBM, low energy	GKMF09

KEY STYLE

Straight key

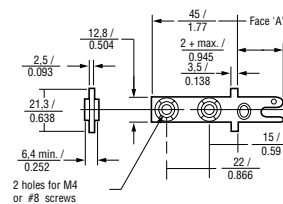
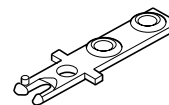

REFERENCE
GKZ51M

Stainless steel

90° key

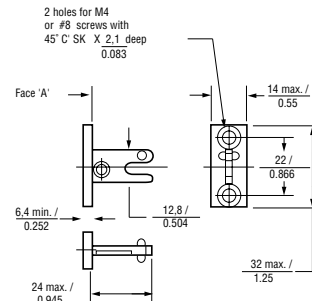
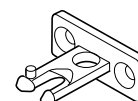

REFERENCE
GKZ52M

Stainless steel

Bottom exit cable

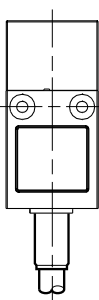

CABLE LENGTH	CONTACT	REFERENCE
1 m	1NC/1NO, BBM	GKMB13
1 m	2NC	GKMB16
1 m	2NC, low energy	GKMB17
1 m	1NC/1NO, BBM, low energy	GKMB19
2 m	1NC/1NO, BBM	GKMB23
2 m	2NC	GKMB26
2 m	2NC, low energy	GKMB27
2 m	1NC/1NO, BBM, low energy	GKMB29
3 m	1NC/1NO, BBM	GKMB33
3 m	2NC	GKMB36
3 m	2NC, low energy	GKMB37
3 m	1NC/1NO, BBM, low energy	GKMB39

GSS Series Hinge Mount Safety Limit Switch



The Hinge Mount Safety Limit Switch is designed for use on machine access doors as an alternative solution to key operated interlocks and safety limit switches. When the access door is opened, a follower pin (not supplied) slides down the slot in the actuator lever, forcing the actuator lever to rotate and positively open the NC safety circuit to shut off the machine. Closing the access door rotates the actuator lever to the reset position, closing the NC safety contacts.

The Hinge Mount Safety Limit Switch minimizes alignment problems because it may be offset-mounted from the hinge point of the door. The tamper-resistant design and the positive opening contacts provide a higher level of safety than the conventional spring-driven limit switches often used to monitor door position.

Low Energy Switching

In today's demanding age of low energy controls, electromechanical switches are frequently used to interface directly with safety relays, PLCs and other low energy devices. To accommodate this requirement GSS offers a new gold plated contact version of the standard basic switch. This improves reliability of switching at low currents and voltages by protecting the contact surfaces from contamination during operation or storage prior to use.

Standard silver contacts have a disadvantage in that the contact surface may tarnish under certain environmental conditions, e.g. in the presence of moisture.

Low energy basic switches are rated as follows:

Operating Voltage U_e 1 Vdc to 60 Vdc or 1 Vac to 125 Vac

Operating Current I_e 1 mA to 50 mA

Example of catalog listing using a low energy basic switch - GSCB33S2.

Switching options:

GSC/D

Snap action contacts (1NC/1NO)

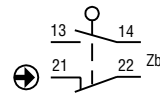

Slow action contacts (1NC/1NO) BBM

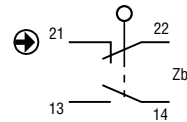

Slow action contacts (2NC)

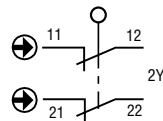

GSE

Slow action contacts (4NC)

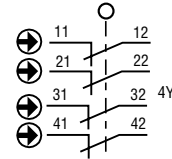

Slow action contacts (2NC/2NO) BBM

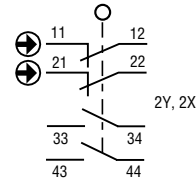

Slow action contacts (3NC/1NO) BBM

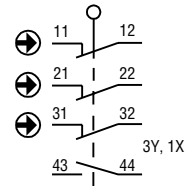

Electrical ratings:

Designation & Utilization Category		IEC 60947-5-1/EN 60947-5-1						VA rating	
		Rated operational current I_e (A) at rated operational voltage U_e						Make	Break
		120 V	240 V	380 V	480 V	500 V	600 V		
AC15	A600	6	3	1,9	1,5	1,4	1,2	7200	720
AC15	A300	6	3	-	-	-	-	7200	720
AC15	B300	3	1,5	-	-	-	-	3600	360
AC14	D300	0,6	0,3	-	-	-	-	432	72
		125 V	250 V						
DC13	Q300	0,55	0,27					69	69
DC13	R300	0,22	0,1					28	28

**GSC Metal body
GSD Plastic body
EN 50047
Safety Standard**

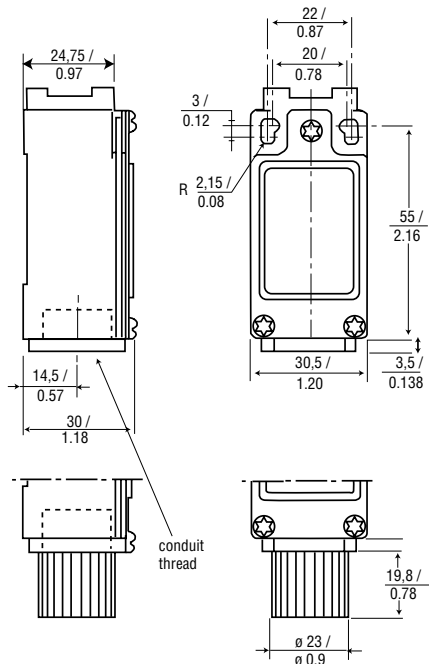

Mechanical life: up to 1 million
Sealing: IP 66
 (GSC) NEMA 1, 4, 12, 13
 (GSD) NEMA 1, 12, 13
Operating temperature: -25 °C to 85 °C
 (-13 °F to 185 °F)
Approvals: IEC/EN 60947-5-1
 AC15 A300
 DC13 Q300
 UL, CSA, BG

ACTUATED SWITCHES

*Rotated 90° to the left
from center*

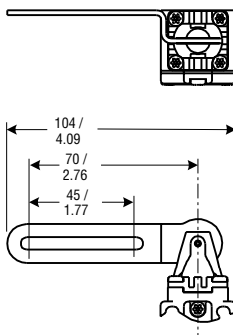

GSC - Metal body

CONTACT	CONDUIT	REFERENCE
1NC/1NO	½ in NPT	GSCA01S1
1NC/1NO, BBM	½ in NPT	GSCA03S1
2NC	½ in NPT	GSCA06S1
2NC, low energy	20 mm	GSCC36S1

GSD - Plastic body

CONTACT	CONDUIT	REFERENCE
1NC/1NO, BBM	½ in NPT	GSDA03S1
2NC	½ in NPT	GSDA06S1
1NC/1NO, BBM	PG 13,5	GSDB03S1
2NC	PG 13,5	GSDB06S1
1NC/1NO	20 mm	GSDC01S1

*Rotated 90° to the right
from center*

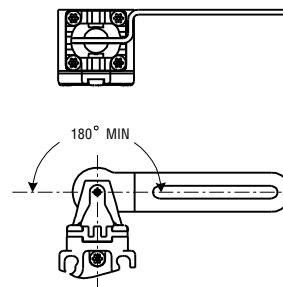

GSC - Metal body

CONTACT	CONDUIT	REFERENCE
1NC/1NO	½ in NPT	GSCA01S3
1NC/1NO, BBM	½ in NPT	GSCA03S3
2NC	½ in NPT	GSCA06S3
2NC, low energy	PG 13,5	GSCB36S3

GSD - Plastic body

CONTACT	CONDUIT	REFERENCE
1NC/1NO, BBM	½ in NPT	GSDA03S3
2NC	½ in NPT	GSDA06S3
1NC/1NO, BBM	PG 13,5	GSDB03S3
2NC	PG 13,5	GSDB06S3
1NC/1NO	20 mm	GSDC01S3

*Rotated 90° either direction from
center*

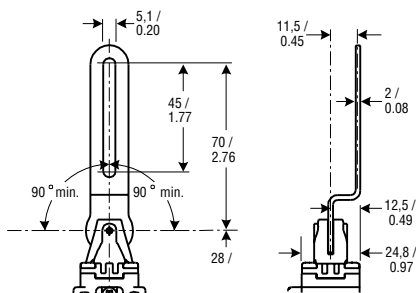

GSC - Metal body

CONTACT	CONDUIT	REFERENCE
1NC/1NO	½ in NPT	GSCA01S2
1NC/1NO, BBM	½ in NPT	GSCA03S2
2NC	½ in NPT	GSCA06S2
2NC, low energy	PG 13,5	GSCB36S2

GSD - Plastic body

CONTACT	CONDUIT	REFERENCE
1NC/1NO, BBM	½ in NPT	GSDA03S2
2NC	½ in NPT	GSDA06S2
1NC/1NO, BBM	PG 13,5	GSDB03S2
2NC	PG 13,5	GSDB06S2
1NC/1NO	20 mm	GSDC01S2

**GSE EN 50047 Compatible
Safety 3 Conduit Metal
Standard**

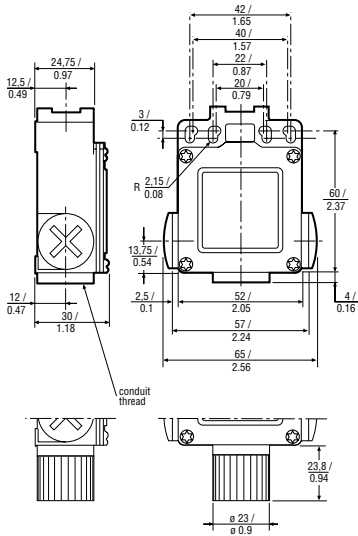

Mechanical life: up to 1 million
Sealing: IP 66, NEMA/UL 1, 4, 12, 13
Operating temperature: -25 °C to 85 °C
 (-13 °F to 185 °F)
Approvals: IEC/EN 60947-5-1
 AC15 A300
 DC13 Q300
 UL, CSA, BG

ACTUATED SWITCHES

*Rotated 90° to the left
from center*

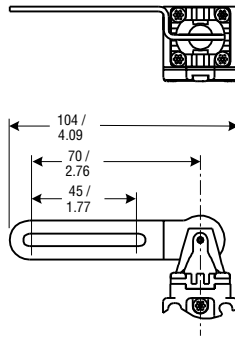

CONTACT	CONDUIT	REFERENCE
2NC/2NO, BBM	½ in NPT	GSEA44S1
3NC/1NO, BBM	½ in NPT	GSEA46S1
4NC, low energy	20 mm	GSEC41S1

*Rotated 90° either direction from
center*

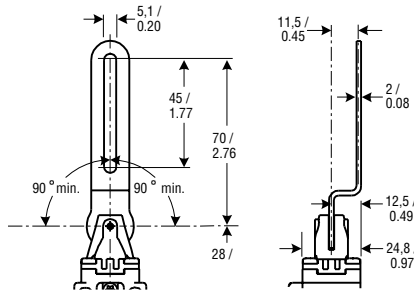

CONTACT	CONDUIT	REFERENCE
2NC/2NO, BBM	½ in NPT	GSEA44S2

*Rotated 90° to the right
from center*

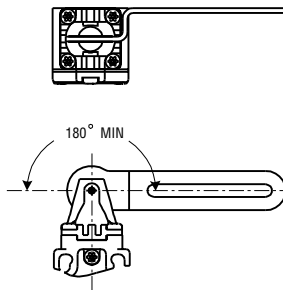

CONTACT	CONDUIT	REFERENCE
2NC/2NO, BBM	½ in NPT	GSEA44S3

GK Series Dual Entry Key Operated Safety Interlock Switch



The GK Series is designed specifically for use on machines where key removal brings the machine to an immediate safe condition. It provides enhanced operator safety when added to hinged or sliding guard doors, screens and protective covers on enclosures. The GK Series is especially well suited for large door applications, typically in the automotive plant floor environment. Its heavy duty construction withstands harsh industrial environments where rugged, long-term durability is required.

Nearly 1000 options are available in a simple to understand part number tree.

A safety lockout device is also available for use with the GK Series. The lockout device (GKZL2) is specifically designed to prevent a key from being inserted either manually, or by the access door being closed while maintenance personnel are working on the machine. When inserted, the lockout device can accommodate up to four padlocks to prevent unauthorised removal of the device.

Mechanical life:

Sealing:

Operating temperature:

Approvals:

up to 15 million
IP 67, NEMA/UL type 1, 4, 12,13
-25 °C to 85 °C (-13 °F to 185 °F)
CE, CSA, UL
AC15 A300/A600
DC13 Q300
Silver
Gold

Contacts:

Switching options:

Snap action contacts (1NC/1NO)

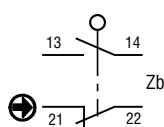

Slow action contacts (1NC/1NO), BBM

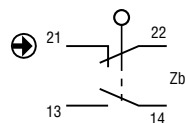

Slow action contacts (2NC/2NO), BBM

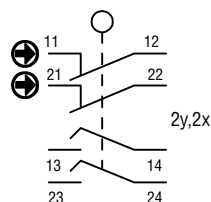

Slow action contacts (4NC)

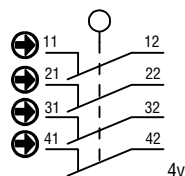

Low energy

Snap action contacts (2NC/2NO)

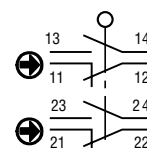

Slow action contacts (2NC)

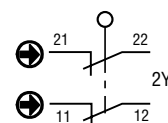

Slow action contacts (3NC/1NO)

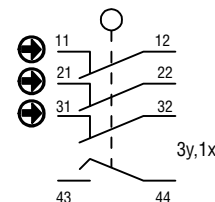

Electrical ratings:

IEC 60947-5-1/EN 60947-5-1								
Designation & Utilization Category	Rated operational current Ie (A) at rated operational voltage Ue						VA rating	
	120 V	240 V	380 V	480 V	500 V	600 V	Make	Break
AC15 A600	6	3	1,9	1,5	1,4	1,2	7200	720
AC15 A300	6	3	-	-	-	-	7200	720
AC15 B300	3	1,5	-	-	-	-	3600	360
AC14 D300	0,6	0,3	-	-	-	-	432	72
	125 V	250 V						
DC13 Q300	0,55	0,27					69	69
DC13 R300	0,22	0,1					28	28

GK Series (continued)

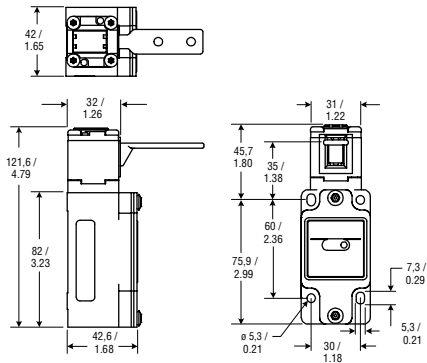

Head orientation

OPTIONS

Opening to front and top

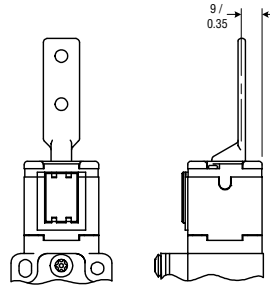

Opening to right and top

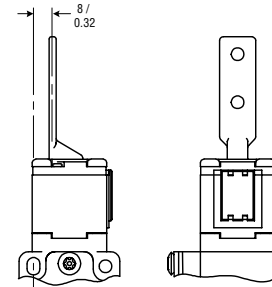

Standard

CONDUIT	CONTACT	KEY	REFERENCE
1/2 NPT	1NC/1NO	90°	GKBA1L7
1/2 NPT	1NC/1NO	Up-down	GKBA1L8-F11*
1/2 NPT	1NC/1NO	None	GKBA1LX
1/2 NPT	4NC	90°	GKBA10L7
1/2 NPT	2NC/2NO, BBM	Straight	GKBA14L6
1/2 NPT	2NC/2NO, BBM	90°	GKBA14L7
1/2 NPT	3NC/1NO, BBM	Straight	GKBA16L6
1/2 NPT	3NC/1NO, BBM	90°	GKBA16L7
1/2 NPT	2NC/NO	Straight	GKBA2L6
1/2 NPT	4NC, low energy	None	GKBA30LX
1/2 NPT	3NC/1NO, BBM, low energy	None	GKBA36LX
1/2 NPT	1NC/1NO, BBM	Straight	GKBA3L6
1/2 NPT	1NC/1NO, BBM	90°	GKBA3L7
1/2 NPT	2NC	None	GKBA6LX
PG 13.5	2NC/2NO, BBM	Straight	GKBB14L6
PG 13.5	1NC/1NO, BBM	90°	GKBB3L7
PG 13.5	2NC	90°	GKBB6L7
20 mm	2NC/2NO, BBM	90°	GKBC14L7
20 mm	1NC/1NO	Straight	GKBC1L6
20 mm	1NC/1NO	90°	GKBC1L7
20 mm	1NC/1NO	None	GKBC1LX
20 mm	2NC/NO	None	GKBC2LX
20 mm	4NC, low energy	None	GKBC30LX
20 mm	3NC/1NO, BBM, low energy	None	GKBC36LX
20 mm	2NC	None	GKBC6LX

* fluorocarbon seal

Single LED indicator

CONDUIT	CONTACT	KEY	REFERENCE
1/2 NPT	2NC/2NO, BBM	straight	GKCA14M6

Opening to left and top

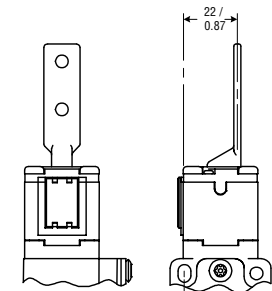

Single LED indicator

CONDUIT	CONTACT	KEY	REFERENCE
1/2 NPT	1NC/1NO	Straight	GKCA1L6
1/2 NPT	1NC/1NO	90°	GKCA1L7
1/2 NPT	1NC/1NO	None	GKCA1LX
1/2 NPT	2NC	None	GKCA6LX
1/2 NPT	4NC	Straight	GKCA10L6
1/2 NPT	2NC/2NO, BBM	Straight	GKCA14L6
1/2 NPT	2NC/2NO, BBM	90°	GKCA14L7
1/2 NPT	2NC/2NO, BBM	Side-side	GKCA14L9
1/2 NPT	4NC, low energy	None	GKCA30LX
1/2 NPT	3NC/1NO, BBM, low energy	None	GKCA36LX
20 mm	1NC/1NO	None	GKCC1LX
20 mm	2NC	None	GKCC6LX
20 mm	4NC, low energy	None	GKCC30LX
20 mm	3NC/1NO, BBM, low energy	None	GKCC36LX

Single LED indicator

CONDUIT	CONTACT	KEY	REFERENCE
1/2 NPT	2NC/2NO, BBM	Straight	GKCA14P6
1/2 NPT	1NC/1NO	90°	GKCA1P7

Double LED indicator

CONDUIT	CONTACT	KEY	REFERENCE
1/2 NPT	2NC/2NO, BBM	90°	GKDA14P7

Double LED indicator

CONDUIT	CONTACT	KEY	REFERENCE
1/2 NPT	2NC/2NO, BBM	90°	GKDA14L7

GKL/GKR Series Dual Entry Solenoid Key Operated Safety Interlock Switch



The GKR (head to the right) and GKL (head to the left) products offer the user an unrivalled range of standard options.

The GKR/GKL product is a key actuated device incorporating a key trapping mechanism. The switch is used on machinery where instant stop and access to the machinery is either impossible (due to the momentum of the machine) or impractical (due to tool or machine damage or scrapped product if the current machine cycle is interrupted).

The switch incorporates an optional manual override feature which allows removal of the key for emergency access.

Over 1000 options are available in a simple to understand part number tree.

A safety lockout device is also available for use with the GKR/GKL Series. The lockout device (GKZL2) is specifically designed to prevent a key from being inserted either manually, or by the access door being closed while maintenance personnel are working on the machine. When inserted, the lockout device can accommodate up to four padlocks to prevent unauthorised removal of the device.

Mechanical life:

Sealing:

Operating temperature:

Approvals:

up to 1 million
IP 68, NEMA/UL type 1, 4, 6P, 12,13
-25 °C to 40 °C (-13 °F to 104 °F)
CE, CSA, UL
AC15 A300/A600
DC13 Q300
Silver
Gold-plated

Contacts:

Low energy

Switching options:

Snap Action
Type 11NC/1NO Direct Opening

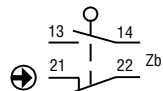

Slow Acting
Type 3
1NC/1NO, Break before make (BBM)

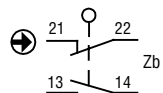

2 Slow Acting
Type 36
3NC/1NO, Break before make (BBM), low energy

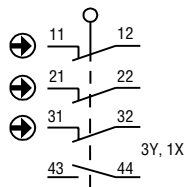

Type 44
2NC/2NO, Break before make (BBM)

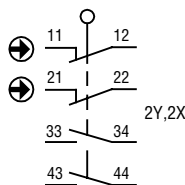

Type 14/15
2NC/2NO, Break before make (BBM)

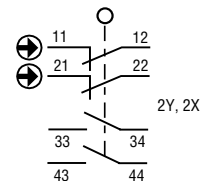

Type 40
4NC

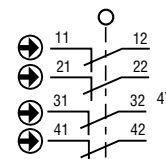

Type 46
3NC/1NO, Break before make (BBM)

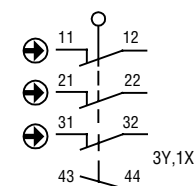

GKL/GKR Series (continued)

Key: Type 6 Straight
 Type 9 Side - side, spring loaded
 Type X No key

Latching mechanism: Type A Mechanical (solenoid unlock with screwdriver)
 Type B Mechanical (without override)
 Type S Electrical (solenoid unlock with screwdriver)

Solenoid voltage: Type 2 24 Vdc
 Type 4 120 Vac

Electrical ratings:

IEC 60947-5-1/EN 60947-5-1									
Designation & Utilization Category		Rated operational current Ie (A) at rated operational voltage Ue						VA rating	
		120 V	240 V	380 V	480 V	500 V	600 V	Make	Break
AC15	A600	6	3	1,9	1,5	1,4	1,2	7200	720
AC15	A300	6	3	-	-	-	-	7200	720
AC15	B300	3	1,5	-	-	-	-	3600	360
AC14	D300	0,6	0,3	-	-	-	-	432	72
		125 V 250 V							
DC13	Q300	0,55	0,27					69	69
DC13	R300	0,22	0,1					28	28

OPTIONS

Opening to front and top

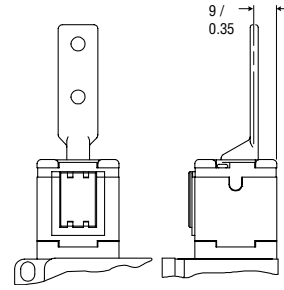

Left

1/2 in - NPT buna-n seals

CONTACT TYPE	KEY	LATCHING TYPE	SOLENOID VOLTAGE	REFERENCE
3 (1NC/1NO, BBM)	None	A	24 Vdc	GKLE3LXA2
40 (4NC)	None	A	24 Vdc	GKLE40LXA2
46 (3NC, BBM)	None	A	24 Vdc	GKLE46LXA2

Right

1/2 in - NPT buna-n seals

CONTACT TYPE	KEY	LATCHING TYPE	SOLENOID VOLTAGE	REFERENCE
40 (4NC)	None	A	24 Vdc	GKRE40LXA2
46 (3NC, BBM)	None	A	24 Vdc	GKRE46LXA2

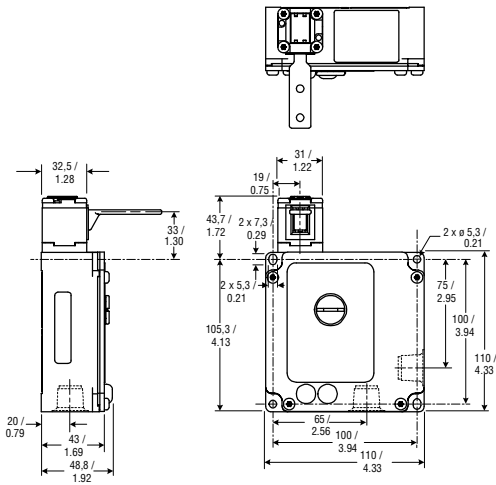

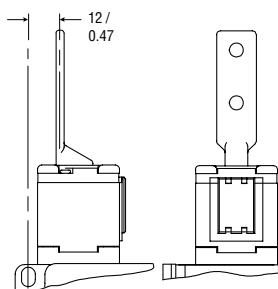
Opening to right and top**Right****1/2 in - NPT buna-n seals**

CONTACT TYPE	KEY	LATCHING TYPE	SOLENOID VOLTAGE	REFERENCE
3 (1NC/1NO, BBM)	None	A	24 Vdc	GKRE3MXA2
3 (1NC/1NO, BBM)	None	A	120 Vac	GKRE3MXA4
3 (1NC/1NO, BBM)	None	S	24 Vdc	GKRE3MXS2
3 (1NC/1NO, BBM)	None	S	120 Vac	GKRE3MXS4
36 (3NC/1NO, BBM, low energy)	None	A	24 Vdc	GKRE36MXA2
36 (3NC/1NO, BBM, low energy)	None	A	120 Vac	GKRE36MXA4
36 (3NC/1NO, BBM, low energy)	None	S	24 Vdc	GKRE36MXS2

20 mm - buna-n seals

CONTACT TYPE	KEY	LATCHING TYPE	SOLENOID VOLTAGE	REFERENCE
1 (1NC/1NO)	None	A	24 Vdc	GKRG1MXA2
1 (1NC/1NO)	None	A	120 Vac	GKRG1MXA4
1 (1NC/1NO)	None	S	24 Vdc	GKRG1MXS2
1 (1NC/1NO)	None	S	120 Vac	GKRG1MXS4
3 (1NC/1NO, BBM)	None	A	24 Vdc	GKRG3MXA2
36 (3NC/1NO, BBM, low energy)	None	A	24 Vdc	GKRG36MXA2
36 (3NC/1NO, BBM, low energy)	None	A	120 Vac	GKRG36MXA4
36 (3NC/1NO, BBM, low energy)	None	S	24 Vdc	GKRG36MXS2
36 (3NC/1NO, BBM, low energy)	None	S	120 Vac	GKRG36MXS4

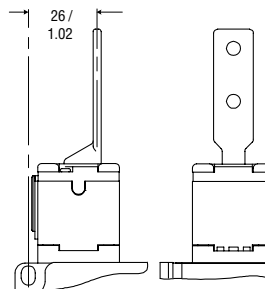
Opening to left and top**Left****1/2 in - NPT buna-n seals**

CONTACT TYPE	KEY	LATCHING TYPE	SOLENOID VOLTAGE	REFERENCE
3 (1NC/1NO, BBM)	None	A	24 Vdc	GKLE3PXA2
3 (1NC/1NO, BBM)	None	A	120 Vac	GKLE3PXA4
3 (1NC/1NO, BBM)	None	S	24 Vdc	GKLE3PXS2
3 (1NC/1NO, BBM)	None	S	120 Vac	GKLE3PXS4
36 (3NC/1NO, BBM, low energy)	None	A	24 Vdc	GKLE36PXA2
36 (3NC/1NO, BBM, low energy)	None	A	120 Vac	GKLE36PXA4
36 (3NC/1NO, BBM, low energy)	None	S	24 Vdc	GKLE36PXS2
36 (3NC/1NO, BBM, low energy)	None	S	120 Vac	GKLE36PXS4

20 mm - buna-n seals

CONTACT TYPE	KEY	LATCHING TYPE	SOLENOID VOLTAGE	REFERENCE
1 (1NC/1NO)	None	A	24 Vdc	GKLG1PXA2
1 (1NC/1NO)	None	A	120 Vac	GKLG1PXA4
1 (1NC/1NO)	None	S	24 Vdc	GKLG1PXS2
1 (1NC/1NO)	None	S	120 Vac	GKLG1PXS4
3 (1NC/1NO, BBM)	None	S	24 Vdc	GKLG3PXS2
36 (3NC/1NO, BBM, low energy)	None	A	24 Vdc	GKLG36PXA2
36 (3NC/1NO, BBM, low energy)	None	A	120 Vac	GKLG36PXA4
36 (3NC/1NO, BBM, low energy)	None	S	24 Vdc	GKLG36PXS2
36 (3NC/1NO, BBM, low energy)	None	S	120 Vac	GKLG36PXS4
44 (2NC/2NO, BBM)	None	B	24 Vdc	GKLG44PXB2

Keys for GK and GKL/GKR switches

Straight key

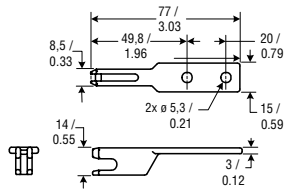

REFERENCE
GKZ56

90° key

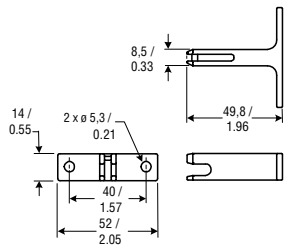

REFERENCE
GKZ57

Spring-loaded key: up/down

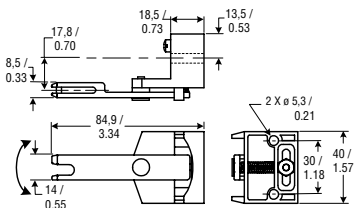

REFERENCE
GKZ58

Spring-loaded key: left/right

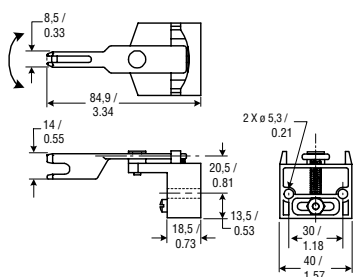

REFERENCE
GKZ59

Locking slider bolt with actuating key

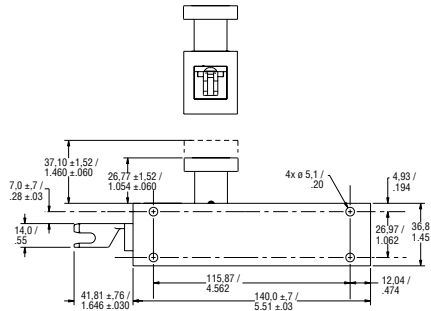
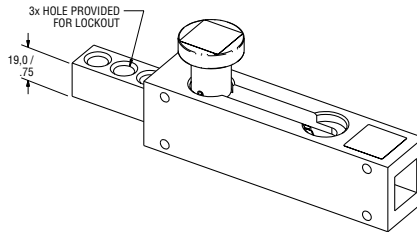

0° key rotation
REFERENCE
GKZ71

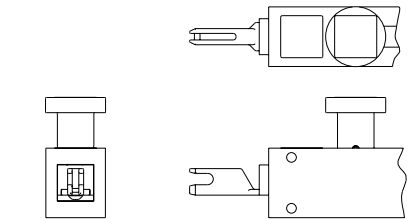

180° key rotation
REFERENCE
GKZ73

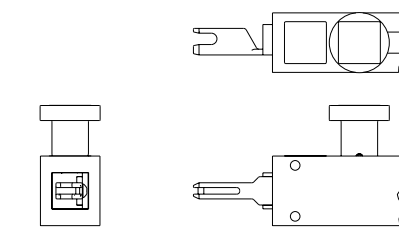

90° key rotation
REFERENCE
GKZ72

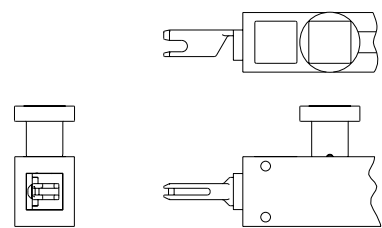

270° key rotation
REFERENCE
GKZ74

CPS Series Cable Pull Safety Switch



CPS Series Cable Pull Safety Switches provide a readily accessible emergency stop signal. This is a cost-effective means compared to using multiple emergency stop push-buttons. (Cable Pull Safety Switches are not, however, to be used as a means of personnel safeguarding. They may be used to prevent further injury or damage to equipment when used for emergency stop signaling.)

The CPS Series Cable Pull Safety switch is designed to provide emergency stop protection for exposed conveyor and assembly lines. The internal mechanism latches on both slackened cable (push) and pulled cable. This capability also enhances productivity by eliminating nuisance stops due to variations in temperature, stretch of cable over time, and other application variables.

The 1CPS is intended for use in applications where the cable span is 76 m (250 ft) or shorter. It is an economical solution for shorter runs or zone protection typical to automated systems. The 2CPS series is intended for use in very long cable runs of 152 m (500 ft) or shorter, such as long conveyor lines found in warehouses.

The CPS complies with: Low Voltage Directive 73/23/EEC, as amended by directive 93/68/EEC; Machinery Directive 98/37/EEC only as the directives relate to the components being used in a safety function; IEC/EN 60947-1; IEC/EN 60947-5-1; IEC/EN 60947-5-5.

Mechanical life:

Sealing:

Operating temperature:

Approvals:

Contacts:

Switching options:

	1CPS	1 000 000
	2CPS	IP67, NEMA 1, 4, 12,13
		-25 °C to 80 °C (-13 °F to 176 °F)
		-40 °C to 80 °C (-40 °F to 176 °F)
		AC15 A300
		DC13 Q300
	1CPS	UL, CSA
	2CPS	UL, CSA, BG
	1CPS	Silver
	1CPS, Low energy	Gold plated
	2CPS	Gold plate over silver

1NC/1NO

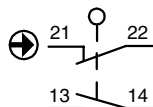

2NC/2NO

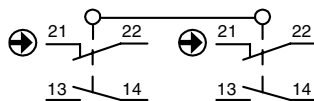

3NC/1NO

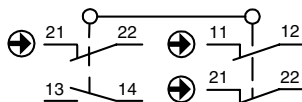

4NC

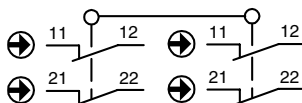

2CPS

N/A

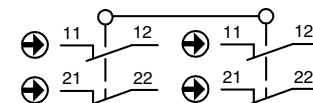
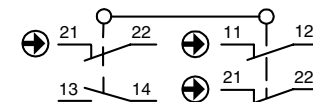
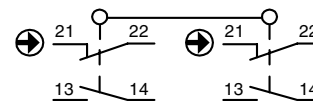

2CPS contact block mounting:

1
2

To housing
Removable with heavy duty terminals

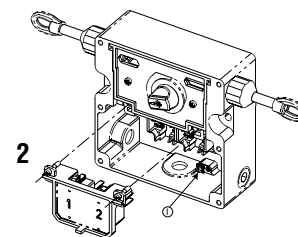
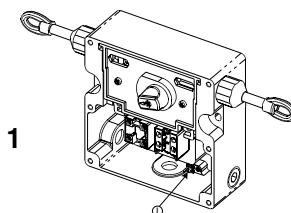

1CPS indicator Light Code:

No letter
A

No indicator provided
24 Vdc red LED
120 Vac red LED

2CPS indicator Light Code:

No letter
A
B

No indicator provided
24 Vdc red multi-cluster LED
120 Vac red multi-cluster LED

CPS Series (continued)

1CPS

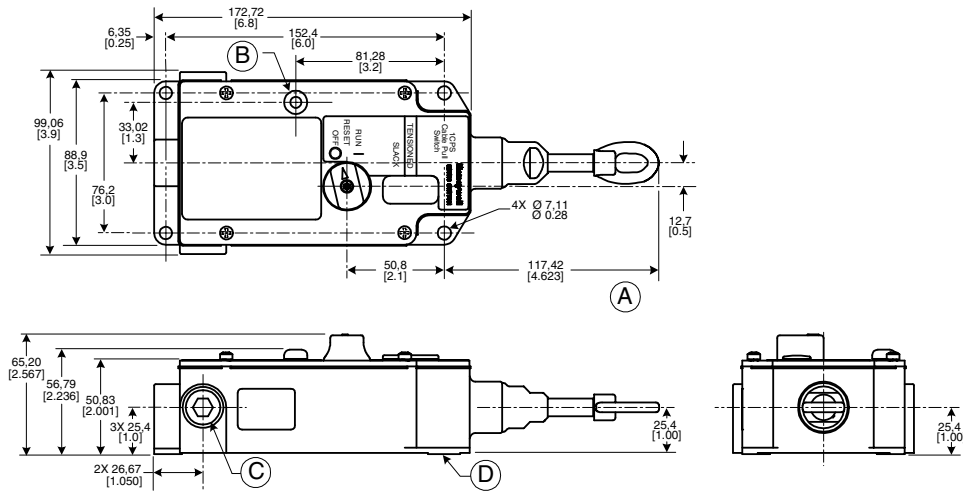

- A Fully extended
- B Optional indicator
- C Conduit thread (3 total)
- D Mounting pad (4 total)

OPTIONS

Cable maintained

1/2 in NPT

CONTACT	INDICATOR	REFERENCE
1NC/1NO	None	1CPSA1
1NC/1NO	24 V	1CPSA1A
1NC/1NO	120 V	1CPSA1B
2NC/2NO	None	1CPSA2
2NC/2NO	24 V	1CPSA2A
2NC/2NO	120 V	1CPSA2B
3NC/1NO	None	1CPSA3
3NC/1NO	24 V	1CPSA3A
3NC/1NO	120 V	1CPSA3B
4NC	None	1CPSA4
1NC/1NO, low energy	None	1CPSA5
2NC/2NO, low energy	None	1CPSA6
2NC/2NO, low energy	24 V	1CPSA6A
2NC/2NO, low energy	120 V	1CPSA6B
3NC/1NO, low energy	None	1CPSA7
4NC, low energy	None	1CPSA8

20 mm

CONTACT	INDICATOR	REFERENCE
1NC/1NO	None	1CPSC1
1NC/1NO	24 V	1CPSC1A
2NC/2NO	None	1CPSC2
2NC/2NO	24 V	1CPSC2A
2NC/2NO	120 V	1CPSC2B
3NC/1NO	None	1CPSC3
3NC/1NO	24 V	1CPSC3A
4NC	None	1CPSC4
1NC/1NO, low energy	None	1CPSC5
2NC/2NO, low energy	None	1CPSC6
2NC/2NO, low energy	24 V	1CPSC6A
3NC/1NO, low energy	None	1CPSC7
4NC, low energy	None	1CPSC8

2CPS

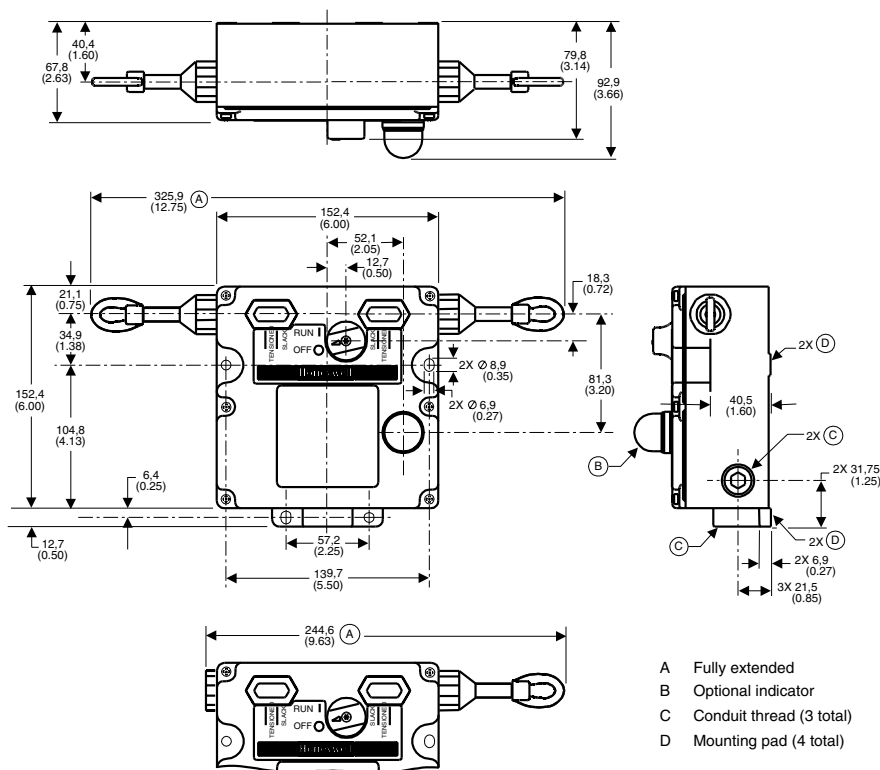

Cable maintained both sides
1/2 in NPT

CONTACT	CONTACT BLOCK MOUNTING	INDICATOR	REFERENCE
2NC/2NO	1	None	2CPSA1A1
2NC/2NO	1	24 Vdc	2CPSA1A1A
2NC/2NO	1	120 Vac	2CPSA1A1B
3NC/1NO	1	None	2CPSA1B1
3NC/1NO	1	24 Vdc	2CPSA1B1A
3NC/1NO	1	120 Vac	2CPSA1B1B
2NC/2NO	2	None	2CPSA2A1
2NC/2NO	2	24 Vdc	2CPSA2A1A
2NC/2NO	2	120 Vac	2CPSA2A1B
3NC/1NO	2	None	2CPSA2B1
3NC/1NO	2	24 Vdc	2CPSA2B1A
3NC/1NO	2	120 Vac	2CPSA2B1B

20 mm

CONTACT	CONTACT BLOCK MOUNTING	INDICATOR	REFERENCE
2NC/2NO	1	None	2CPSC1A1
2NC/2NO	1	24 Vdc	2CPSC1A1A
4NC	1	24 Vdc	2CPSC1D1A

No actuation right side, cable maintained left side
1/2 in NPT

CONTACT	CONTACT BLOCK MOUNTING	INDICATOR	REFERENCE
2NC/2NO	1	None	2CPSA1A2
2NC/2NO	1	24 Vdc	2CPSA1A2A
2NC/2NO	1	120 Vac	2CPSA1A2B
3NC/1NO	1	None	2CPSA1B2
3NC/1NO	1	24 Vdc	2CPSA1B2A
3NC/1NO	1	120 Vac	2CPSA1B2B
2NC/2NO	2	None	2CPSA2A2
2NC/2NO	2	24 Vdc	2CPSA2A2A
2NC/2NO	2	120 Vac	2CPSA2A2B

20 mm

CONTACT	CONTACT BLOCK MOUNTING	INDICATOR	REFERENCE
2NC/2NO	1	None	2CPSC1A2
2NC/2NO	1	24 Vdc	2CPSC1A2A

No actuation left side, cable maintained right side
1/2 in NPT

CONTACT	CONTACT BLOCK MOUNTING	INDICATOR	REFERENCE
2NC/2NO	1	None	2CPSA1A3
2NC/2NO	1	24 Vdc	2CPSA1A3A
2NC/2NO	1	120 Vac	2CPSA1A3B
3NC/1NO	1	None	2CPSA1B3
3NC/1NO	1	24 Vdc	2CPSA1B3A
3NC/1NO	1	120 Vac	2CPSA1B3B
2NC/2NO	2	None	2CPSA2A3
2NC/2NO	2	24 Vdc	2CPSA2A3A
2NC/2NO	2	120 Vac	2CPSA2A3B

20 mm

CONTACT	CONTACT BLOCK MOUNTING	INDICATOR	REFERENCE
2NC/2NO	1	None	2CPSC1A3
2NC/2NO	1	24 Vdc	2CPSC1A3A

CPS Series (continued)

Hardware packets (order separately)

CPS LED

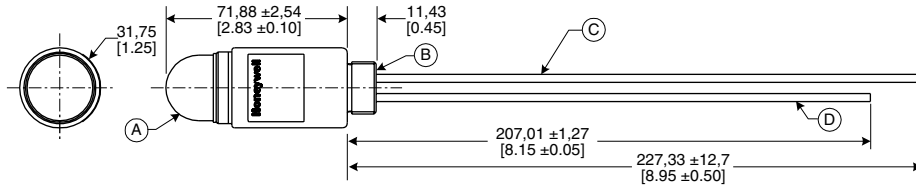

CPS Bracket

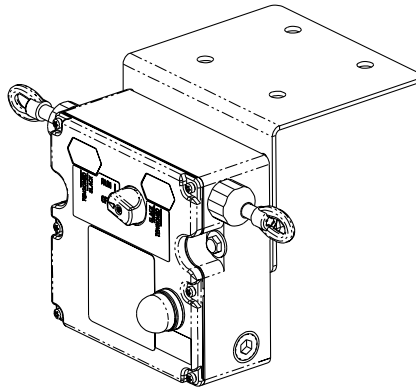

ACCESSORY	REFERENCE
Cable - 7,6 m (25 ft) length	CLSZC1
Cable - 15,2 m (50 ft) length	CLSZC2
Cable - 30,5 m (100 ft) length	CLSZC3
Cable - 45,7 m (150 ft) length	CLSZC4
Cable - 61 m (200 ft) length	CLSZC5
Cable - 76,2 m (250 ft) length	CLSZC7
(2) Thimbles	CLSZTC
(2) Low-profile Duplex Cable Clamps	

ACCESSORY	REFERENCE
(1) Draw-bar Endspring	CPSZ1S
(1) J-hook Turnbuckle with Lock Nuts	CPSZK1
(2) Thimbles	
(2) Low-profile Duplex Cable Clamps	
(16) Sets of Cable Supports ((16) 1/4-20 Eye Bolts, (32) 1/4-20 Nuts, (32) Flat Washers, (16) Lock Washers)	
Multicluster LED Accessory - 24 Vdc (conduit mount)	CPSLED24
Multicluster LED Accessory - 120 Vdc (conduit mount)	CPSLED120
Mounting bracket (to be used with 1CPS or 2CPS)	CPS-BRACKET
J-hook turnbuckle with lock nuts (included with 2CPS)	CPSZTB