

Photoelectrics Diffuse-reflective Types ED 5502/5506

CARLO GAVAZZI



- Range: 200 or 600 mm
- Adjustable sensitivity
- Modulated, infrared light
- Rated operational voltage: 10 to 30 VDC
- Output: DC 200 mA, NPN or PNP
- Make and break switching function, LED indication
- High immunity to ambient light
- Photoelectric, inductive and capacitive flat pack series in PC housing, IP 67
- Cable or M12 plug versions



Product Description

Diffuse-reflective photoelectric with sensing distance up to 600 mm. Easily adjustable sensitivity with 270° potentiometer. LED indication for output ON. Flat pack housing

size (W x H x D) 35 x 55 x 15 mm made in polycarbonate. Easy mounting with only two M3.5 screws. Ideal for use in conveying and material handling applications

Ordering Key

ED 55 06 NPA P-1

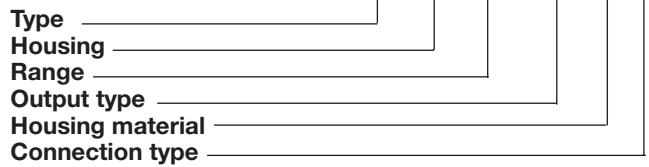

Type Selection

Housing diameter W x H x D	Rated operating dist. (S _n)	Ordering no. NPN/cable Make & break swit.	Ordering no. NPN/plug Make & break swit.	Ordering no. PNP/cable Make & break swit.	Ordering no. PNP/plug Make & break swit.
35 x 55 x 15	200 mm 600 mm	ED 5502 NPAP ED 5506 NPAP	ED 5502 NPAP-1 ED 5506 NPAP-1	ED 5502 PPAP ED 5506 PPAP	ED 5502 PPAP-1 ED 5506 PPAP-1

Specifications

Rated operating dist. (S_n)	ED 5502 Up to 200 mm ED 5506 Up to 600 mm Reference target: Kodak test card R27, white, 90% reflectivity ED 5502 100 x 100 mm ED 5506 200 x 200 mm	Protection	Reverse polarity, short-circuit, transients
Adjustable range	ED 5502 50 to 200 mm ED 5506 150 to 600 mm	Transient voltage	Max. 1 kV/0.5 J
Temperature drift	0.5%/°C	Sensitivity	Adjustable, 270° turn potentiometer
Hysteresis (H) (Differential travel)	< 20%	Light source Light type	GaAlAs LED, 880 nm Infrared, modulated, synchronized
Rated operational volt. (U_B)	10 to 30 VDC (ripple included)	Sensing angle Ambient light	± 25° at 1/2 range Max. 10,000 lux
Ripple (U_{rip})	≤ 10%	Operating frequency (f)	ED 5502 500 Hz, light/dark ratio 1:2 ED 5506 100 Hz, light/dark ratio 1:2
Output current Continuous (I _a) Short-time (I) Max. load capacity	≤ 200 mA 200 mA 100 nF	Response time OFF-ON (t _{ON}) ON-OFF (t _{OFF})	ED 5502 ≤ 0.67 ms ED 5506 ≤ 4 ms ED 5502 ≤ 1.33 ms ED 5506 ≤ 6 ms
No load supply current (I_o)	≤ 30 mA,	Power ON delay (t_v)	Typ. 100 ms
Min. load current (I_m)	0.5 mA	Indication Output ON	LED, yellow (indicates the present of a target or object)
OFF-state current (I_i)	≤ 100 μA	Environment	
Voltage drop (U_d)	≤ 2.5 V	Overvoltage category Pollution degree Degree of protection	III (IEC 60664/664A; 60947-1) 3 (IEC 60664/664A; 60947-1) IP 67 (IEC 60529; 60947-1)

Specifications (cont.)

Temperature Operating Storage	-20° to +60°C (-4° to +140°F) -30° to +70°C (-22° to +158°F)	Connection Cable	Grey, 2 m, oilproof PVC, 4 x 0.34 mm ²
Vibration	10 to 150 Hz, 0.5 mm/7.5 g (IEC 60068-2-6)	Note: Plug (-1)	Other cable lengths on request M12, CONH1A-.. serie
Shock	2 x 1 m & 100 x 0.5 m (IEC 60068-2-32)	Weight	125 g cable version 40 g plug version
Dielectric voltage	500 VAC (rms)	CE-marking	Yes
Housing material	Polycarbonate, black		

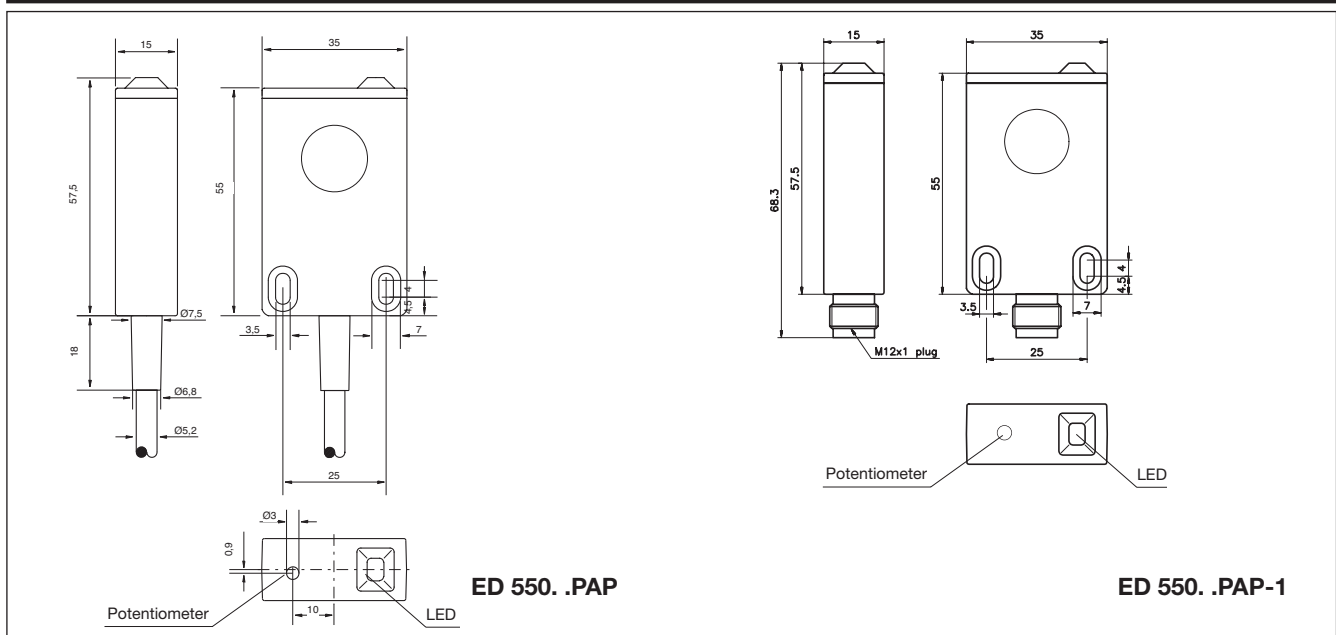

Dimensions

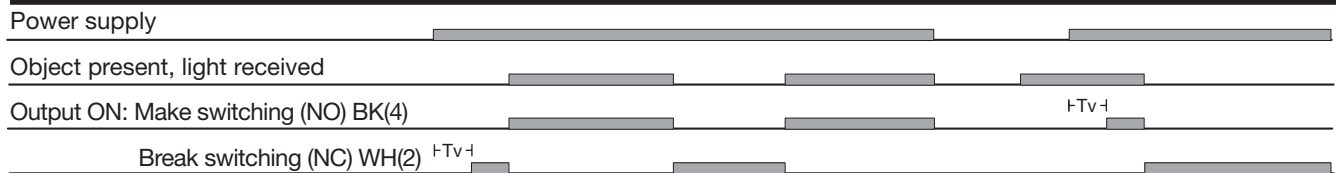

Operation Diagram

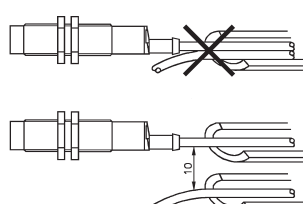
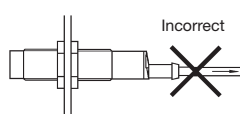

Installation Hints

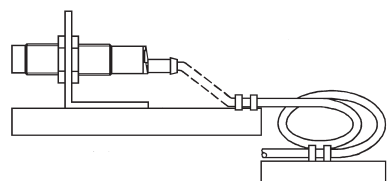
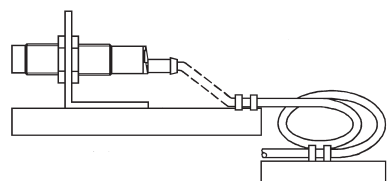
<p>To avoid interference from inductive voltage/current peaks, separate the prox. switch power cables from any other power cables, e.g. motor, contactor or solenoid cables</p> 	<p>Relief of cable strain</p> <p>Incorrect</p>  <p>Correct</p>  <p>The cable should not be pulled</p>	<p>Protection of the sensing face</p>  <p>A proximity switch should not serve as mechanical stop</p>	<p>Switch mounted on mobile carrier</p>  <p>Any repetitive flexing of the cable should be avoided</p>
--	---	---	--

Truth Table

	Make switching		Break switching	
	No	Yes	No	Yes
Object present	No	Yes	No	Yes
DC types				
LED	OFF	ON	OFF	ON
Load	Non-active	Active	Active	Non-active
Output NPN	High	Low	Low	High
Output PNP	Low	High	High	Low

Wiring Diagrams

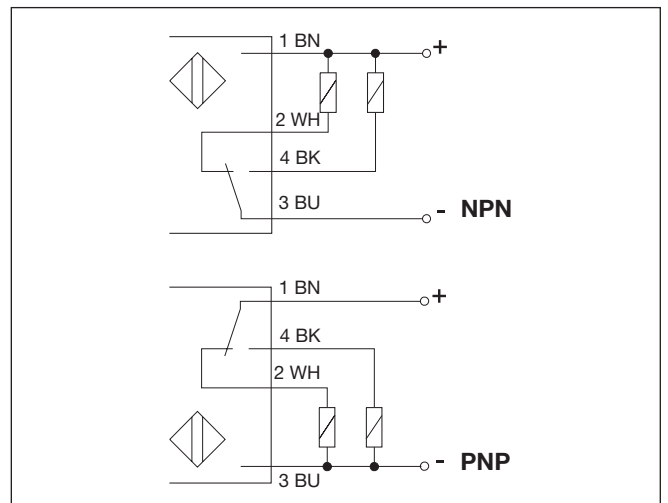

Accessories

- Connector type CON.1A../CON.14NF.. series

Delivery Contents

- Photoelectric switch: ED 550.
- Screw driver
- Packaging: plastic bag