

# Keysight Technologies

## 8 Hints for Better Scope Probing

Application Note

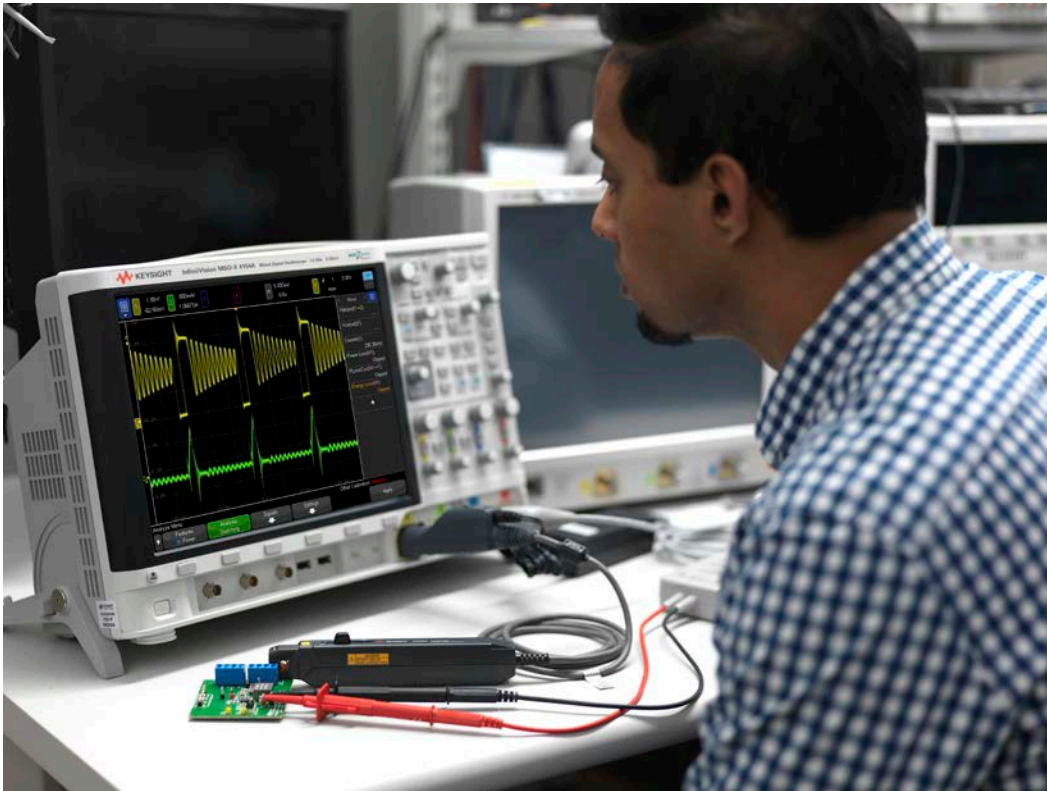



# Introduction

## 8 Hints for Better Scope Probing

Probing is critical for making quality oscilloscope measurements, and often a probe is the first link in your oscilloscope measurement chain. If probe performance is not adequate for your application, you will see distorted or misleading signals on your oscilloscope. Selecting the right probe for your application is the first step toward making reliable measurements. How you use the probe also affects your ability to make accurate measurements and obtain useful measurement results. In this application note, you will find eight useful hints for selecting the right probe for your application and for making your scope probing better. The following probing tips will help you avoid most common probing pitfalls.

**Hint #1** – Passive or active probe?

**Hint #2** – Probe loading check with two probes

**Hint #3** – Compensate probe before use

**Hint #4** – High sensitivity, wide dynamic range current measurement

**Hint #5** – Make safe floating measurements with a differential probe

**Hint #6** – Check the common mode rejection

**Hint #7** – Check the probe coupling

**Hint #8** – Damp the resonance

## Hint #1

### Passive or active probe?

For general-purpose mid-to-low-frequency (less than 600-MHz) measurements, passive high-impedance resistor divider probes are good choices. These rugged and inexpensive tools offer wide dynamic range (greater than 300 V) and high input resistance to match a scope's input impedance. However, they impose heavier capacitive loading and offer lower bandwidths than low-impedance ( $z_0$ ) passive probes or active probes. All in all, high-impedance passive probes are a great choice for general-purpose debugging and troubleshooting on most analog or digital circuits.

For high-frequency applications (greater than 600 MHz) that demand precision across a broad frequency range, active probes are the way to go. They cost more than passive probe and their input voltage is limited, but because of their significantly lower capacitive loading, they give you more accurate insight into fast signals.

In Figure 1-1 we see screen shots from a 600 MHz scope (the Keysight Technologies, Inc. DSO 9064A) measuring a signal that has a 500 psec rise time. On the left, a Keysight N2873A 500 MHz passive probe was used to measure this signal. On the right, a Keysight N2796A 2 GHz single-ended active probe was used to measure the same signal. The yellow trace shows the signal before it was probed and is the same in both cases. The green trace shows the signal after it was probed, which is the same as the input to the probe. The purple trace shows the measured signal, or the output of the probe.

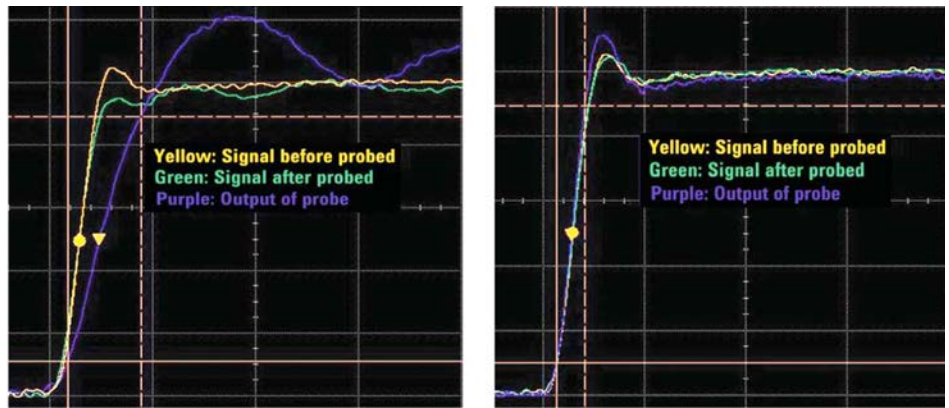

Figure 1-1. Comparison of passive and active probe measuring a signal that has a 600 psec rise time.

Keysight N2873A 500-MHz passive probe with 15-cm alligator ground lead

- Signal loaded, now has 740 psec edge
- Probe output contains resonance and measures 1.4 nsec edge

Keysight N2796A 2-GHz active probe with 1.8-cm ground lead

- Signal unaffected by probe, still has 630 psec edge
- Probe output matches signal and measure 555 psec

A passive probe loads the signal down with its input resistance, inductance and capacitance (green trace). You probably expect that your oscilloscope probe will not affect your signals in your device under test (DUT). However, in this case the passive probe does have an effect on the DUT. The probed signal's rise time becomes 4 ns instead of the expected 600 psec, partly due to the probe's input impedance, but also due to its limited 500-MHz bandwidth in measuring a 583-MHz signal ( $0.35/600$  psec = 583 MHz). The inductive and capacitive effects of the passive probe also cause overshoot and ripping effects in the probe output (purple trace). Some designers are not concerned about this amount of measurement error. For others, this amount of measurement error is unacceptable.

We can see that the signal is virtually unaffected when we attach an active probe such as Keysight's N2796A 2 GHz active probe to the DUT. The signal's characteristics after being probed (green trace) are nearly identical to its un-probed characteristics (N2796A 2 GHz trace). In addition, the rise time of the signal is unaffected by the probe being maintained at 555 psec. Also, the active probe's output (green trace) matches the probed signal (purple trace) and measures the expected 600 psec rise time. Using the 1156A active probe's 2 GHz bandwidth with superior signal fidelity and low probe loading makes this possible.



## Hint #2

### Probe loading check with two probes

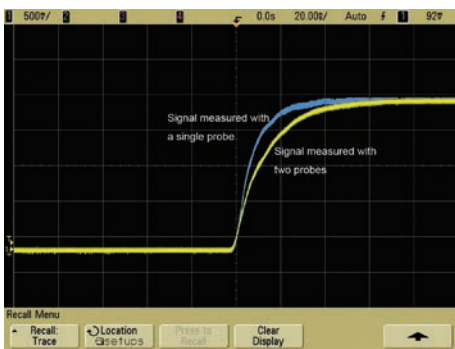
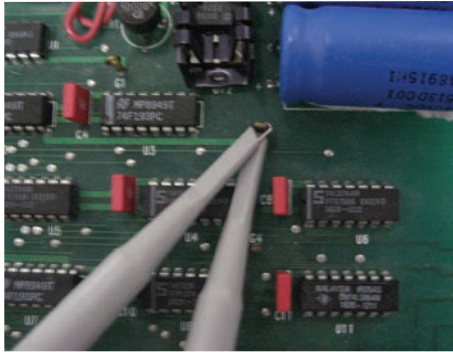

Figure 2-1. Probe loading check with two probes.

Key differences between passive and active probes are summarized below in Figure 1-2.

	High impedance passive probe	Active probe
Power requirement	No	Yes
Loading	Heavy capacitive loading and low Resistive loading	Best overall combination of resistive and capacitive loading
Bandwidth	Up to 700 MHz	Up to 30 GHz
Applications	General purpose mid-to-low frequency measurements	High-frequency applications
Ruggedness	Very rugged	Less rugged
Max input voltage	~ 300 V	~ 40 V
Typical prices	\$100 to \$500	> \$1 k

Figure 1-2. Comparison of high-impedance passive and active probes.

Before probing a circuit, connect your probe tip to a point on your circuit and then connect your second probe to the same point. Ideally, you should see no change on your signal. If you see a change, it is caused by the probe loading.

In an ideal world, a scope probe would be a non-intrusive (having infinite input resistance, zero capacitance and inductance) wire attached to the circuit of interest and it would provide an exact replica of the signal being measured. But in the real world, the probe becomes part of the measurement and it introduces loading to the circuit.

To check the probe loading effect, first, connect one probe to the circuit under test or a known step signal and the other end to the scope's input. Watch the trace on the scope screen, save the trace and recall it on the screen so that the trace remains on the screen for a comparison. Then, using another probe of the same kind, connect to the same point and see how the original trace changes over the double probing.

You may need to make adjustments to your probing or consider using a probe with lower loading to make a better measurement. For instance, in this example, shortening the ground lead did the trick. In Figure 2-2, the circuit ground is probed with a long 18 cm (7") ground lead.

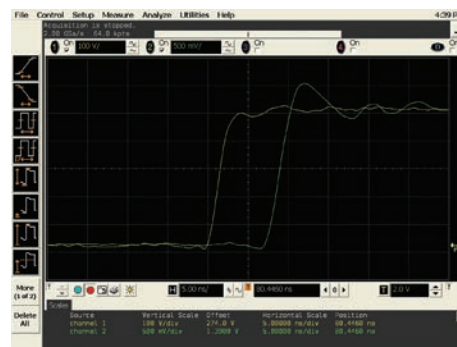

Figure 2-2. Probe loading caused by a long ground lead.



## Hint #3

### Compensate probe before use

Most probes are designed to match the inputs of specific oscilloscope models. However, there are slight variations from scope to scope and even between different input channels in the same scope. Make sure you check the probe compensation when you first connect a probe to an oscilloscope input because it may have been adjusted previously to match a different input. To deal with this, most passive probes have built-in compensation RC divider networks. Probe compensation is the process of adjusting the RC divider so the probe maintains its attenuation ratio over the probe's rated bandwidth.

If your scope can automatically compensate for the performance of probes, it makes sense to use that feature. Otherwise, use manual compensation to adjust the probe's variable capacitance. Most scopes have a square wave reference signal available on the front panel to use for compensating the probe. You can attach the probe tip to the probe compensation terminal and connect the probe to an input of the scope. Viewing the square wave reference signal, make the proper adjustments on the probe using a small screw driver so that the square waves on the scope screen look square.

In Figure 2-3, the same signal ground is probed with a short spring-loaded ground lead. The ringing on the probed signal (purple trace) went away with the shorter ground lead.

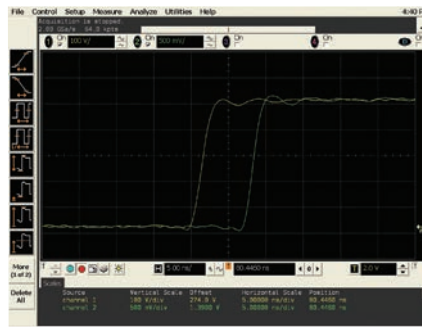

Figure 2-3. Reduced probe loading with short ground lead.



Figure 3-1. Use a small screw driver to adjust the probe's variable capacitance.

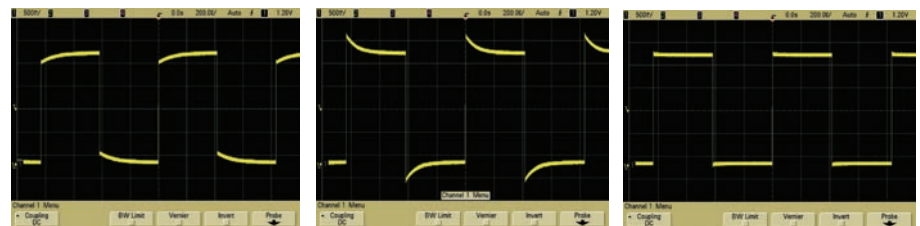
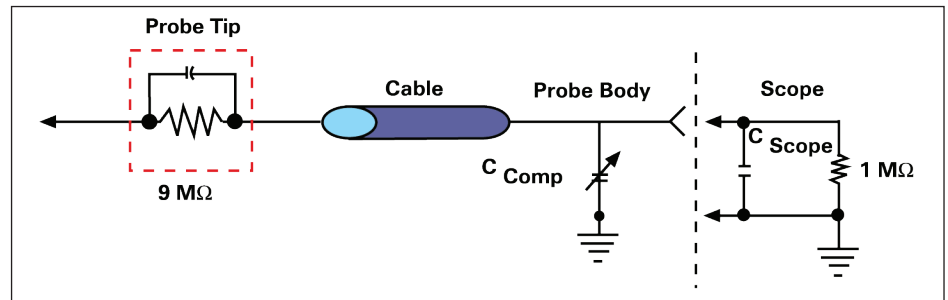

Figure 3-2. Compensation adjustment corresponds to the flat square wave.

The diagram at the top of Figure 3-2 shows how to properly adjust the compensating capacitor in the termination box at the end of the probe. As you can see in the picture, you can have either overshoot or undershoot on the square wave when the low-frequency adjustment is not properly made. This will result in high-frequency inaccuracies in your measurements. It's very important to make sure this compensation capacitor is correctly adjusted.





## Hint #4

### Low current measurement tips

As modern battery-powered devices and integrated circuits become more green and energy efficient, there is a growing need to make high sensitivity, low level current measurements to ensure these devices' current consumption is within acceptable limits. The key applications calling for accurate power consumption measurement are battery-powered applications such as wireless mobile devices and consumer electronics. To maximize the battery life, engineers need to minimize the power consumption over the life of the product. Power is defined as  $P = V \times I$ . The key enabler of reducing the power consumption of a device is to lower the average current consumption for a fixed supply voltage level.

A primary challenge in measuring the current consumption of battery-powered mobile devices, such as a cell phone or a tablet computer, is that the dynamic range of the current signal is very wide. The mobile device typically switches back and forth between active states, where it draws very high and fast peak currents, and an idle or standby current mode, where it draws very small DC and AC currents.

Figure 4-1 shows the current drain measured on a GSM cell phone when making a call. The active current peaks as high as ~2 A, and at idle mode, the current drain is extremely small.

A simple way to measure a current with an oscilloscope is to use a clamp-on type current probe such as Keysight's 1147B or N2893A to directly monitor the current going into the device.

Unfortunately, this approach is not appropriate for measuring small currents that rapidly change between sub-milli amps and several amps because of the limited dynamic range and sensitivity of the clamp-on type current probe, which is limited to a few milli amps. In the example for measuring the current consumption of a mobile phone, the idle state current is not quite measurable because it is buried in the probe noise.

Also, for a more accurate measurement, one would occasionally degauss the probe to remove residual magnetism from the probe core and compensate for any DC offset of the clamp-on current probe. This extra calibration procedure makes the clamp-on current probe cumbersome to use.

The new N2820A Series high-sensitivity current probes from Keysight Technologies address the need for high-sensitivity current measurements with a wide dynamic range. These probes also offer the advantage of physically small connections to the device under test (DUT) since today's application environments require an extremely small form factor. The new N2820A/21A AC/DC current probes offer the industry's highest sensitivity among oscilloscope current probes, going all the way down to 50  $\mu\text{A}$  with a maximum current range of 5 A.

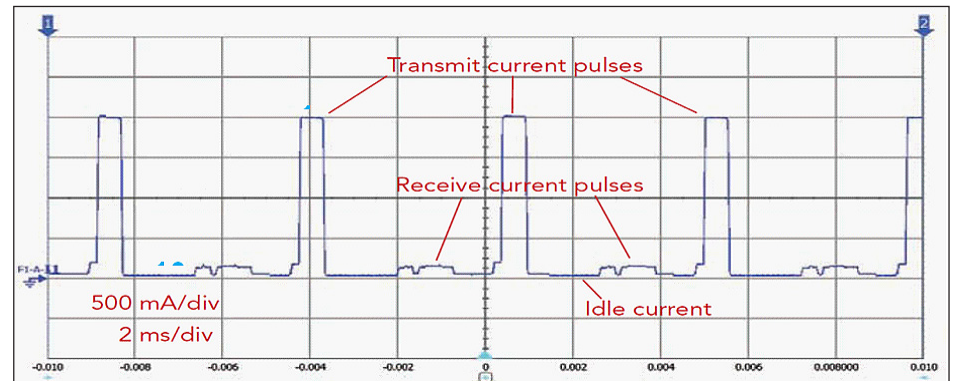

Figure 4-1. The current drain measured on a GSM cell phone when making a call.



Figure 4-2. A simple way to measure a current with an oscilloscope is to use a clamp-on type current probe such as Keysight's 1147B or N2893A.



## Hint #4 (Continued)

### Low current measurement tips

Keysight's N2820A 2-channel high sensitivity current probe comes with two parallel differential amplifiers inside the probe with different gain settings, where the low gain side allows you to see the entire waveform or the "zoom out" view of the waveform and the high gain amplifier provides a "zoom in" view to observe extremely small current fluctuations, such as a mobile phone's idle state. The N2820A/21A current probes are optimized for measuring the current flow within the DUT to characterize sub-circuits, allowing the user to see both large signals and details on fast and wide-dynamic current waveforms.

The probe offers an innovative method of connecting the probe to your DUT. The supplied Make-Before-Break (MBB) connectors allow you to quickly probe multiple locations on your DUT without having to solder or unsolder the leads. The MBB header may be mounted on your target board or wired out of the DUT. It fits into standard 0.1" spacing thru-holes for 0.025" square pins. Users should plan their PCB layouts accordingly. The MBBs are a great way to easily connect and disconnect across multiple locations on the target board without interrupting the circuit under test.

The innovation hasn't stopped there. With current waveforms captured, you now want to calculate the average current consumption of the system over time. Keysight's Infiniium and InfiniiVision oscilloscopes provide an area under the curve measurement (Charge), where you can easily calculate the integrated current consumptions in Ah (Ampere x Hour) over time. The 'Ah' is a unit of measurement of a battery's electrical storage capacity. One Ah is equal to a current of one ampere flowing for one hour.

Now with the N2820A/21A current probes, engineers in battery-powered product testing are able to see the details and the big picture on dynamic current waveforms like never before with traditional clamp on probes.

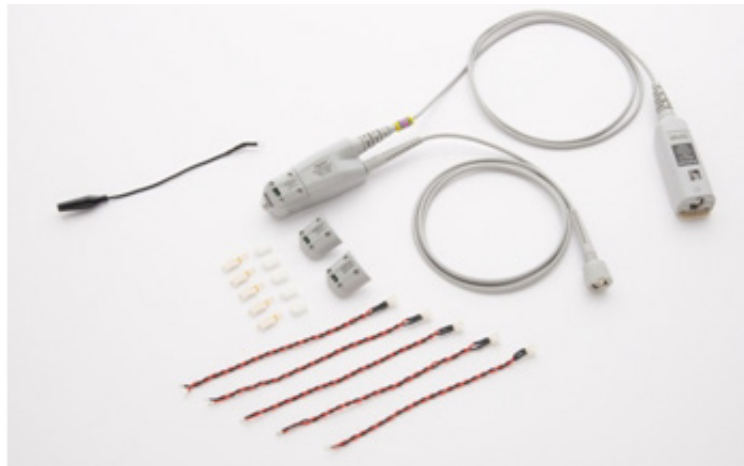

Figure 4-3. The new N2820A/21A AC/DC current probes offer the industry's highest sensitivity among oscilloscope current probes.



Figure 4-4. The supplied Make-Before-Break (MBB) connectors allow you to quickly probe multiple locations on your DUT without having to solder or unsolder the leads.

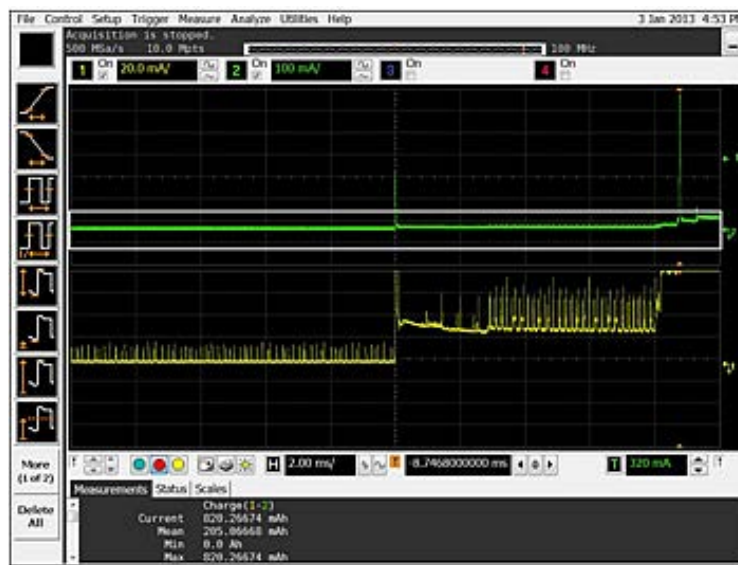

Figure 4-5. Keysight's Infiniium and InfiniiVision oscilloscopes provide an area under the curve measurement (Charge), where you can easily calculate the integrated current consumptions in Ah (Ampere x Hour) over time.



## Hint #5

### Making safe floating measurements with a differential probe

Scope users often need to make floating measurements where neither point of the measurement is at earth ground potential. For example, suppose you measure a voltage drop across the input and output of a linear power supply's series regulator U1. Either the voltage in or out pin of the regulator is not referenced to ground.

A standard oscilloscope measurement where the probe is attached to a signal point and the probe tip ground lead is attached to circuit ground is actually a measurement of signal difference between the test point and earth ground. Most scopes have their signal ground terminals (or outer shells of the BNC interface) connected to the protective earth ground system. This is done so that all signals applied to the scope have a common connection point. Basically all scope measurements are with respect to "earth" ground. Connecting the ground connector to any of the floating points essentially pulls down the probed point to the earth ground, which often causes spikes or malfunctions on the circuit. How do you get around this floating measurement problem?

A popular yet undesirable solution to the need for a floating measurement is the "A-B" technique using two single-ended probes and a scope's math function.

Most digital oscilloscopes have a subtract mode where the two input channels can be electrically subtracted to give the difference in a differential signal. For decent results, each probe used should be matched and compensated before using it. In this method, the common mode rejection ratio is typically limited to less than  $-20$  dB (10:1). If the common mode signal on each probe is very large and differential signal is much smaller, any gain difference between the two sides will significantly alter their "differential" or "A-B" result. A good sanity check here would be to double probe the same signal and see what the "A-B" shows them.

Using a high-voltage differential probe such as Keysight's N2790A is a much better solution for making safe, accurate floating measurements with any oscilloscope. With a true differential amplifier in the probe head, the N2790A is rated to measure differential voltage up to 1,400 VDC + peak AC with CMRR of  $-70$  dB at 10 MHz. Use a differential probe with sufficient dynamic range and bandwidth for your application to make safe and accurate floating measurements.

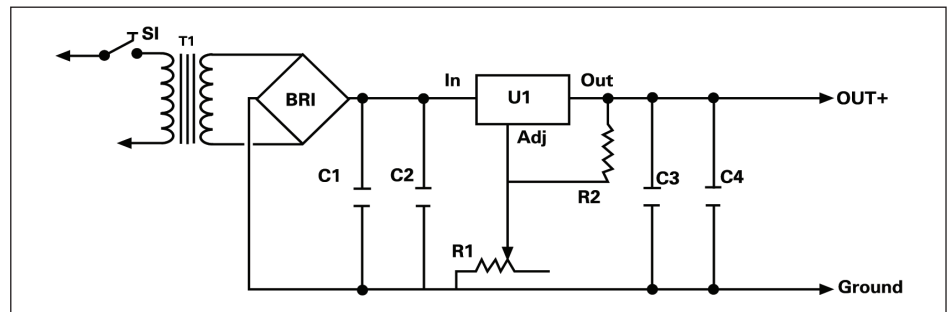

Figure 5-1. When measurement is not ground referenced, a differential measurement solution is necessary.

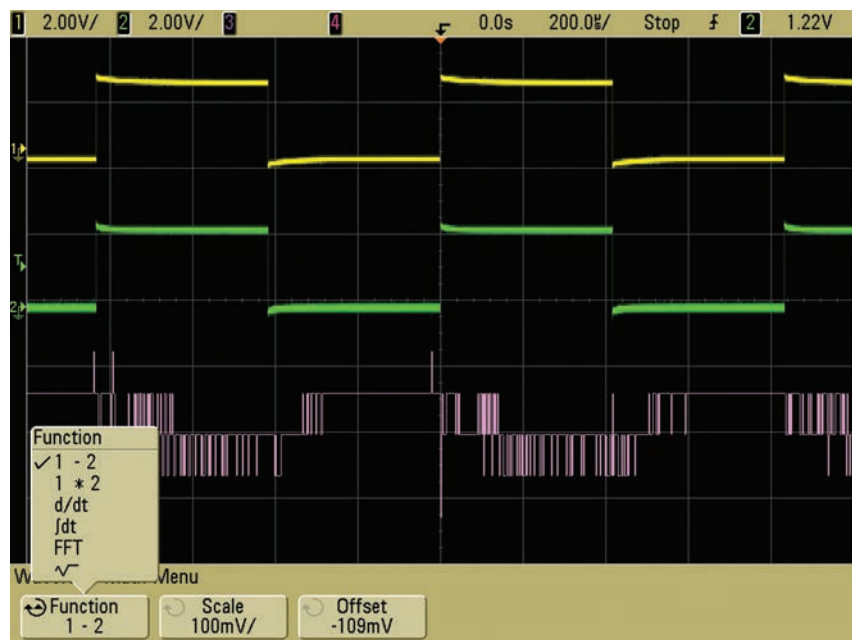

Figure 5-2. As a sanity check, double probe the same signal and see what the "A-B" looks like.





## Hint #6

### Check the common mode rejection

One of the most misunderstood issues with probing is that common mode rejection can limit the quality of a measurement. With either a single-ended or differential probe, it is always worthwhile to connect both probe tips to the ground of the DUT and see if any signals appear on the screen.

If signals appear, they show the level of signal corruption that is due to lack of common mode rejection. Common mode noise currents caused by sources other than the signal being measured can flow from ground in the DUT through the probe ground and onto the probe cable shield. Sources of common mode noise can be internal to the DUT or external to it, such as power line noise, EMI or ESD currents.

A long ground lead on a single-ended probe can make this problem very significant. A single-ended probe does suffer from lack of common mode rejection. Differential active probes provide much higher common-mode rejection ratios, typically as high as 80 dB (10,000:1).



Figure 6-1. Connect both probe tips to the ground and see if any signals appear on the screen.

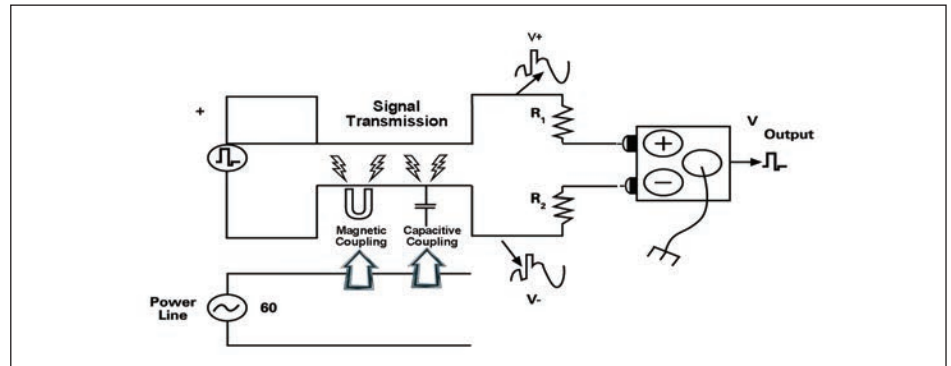

Figure 6-2. Differential active probe provides much higher common mode rejection ratio effectively eliminating common mode noise current.



## Hint #7

### Check the probe coupling

With your probe connected to a signal, move the probe cable around and grab it with your hands. If the waveform on the screen varies significantly, energy is being coupled onto the probe shield, causing this variation. Using a ferrite core on the probe cable may help improve probing accuracy by reducing the common mode noise currents on the cable shield. A ferrite core on the probe cable generates a series impedance in parallel with a resistor in the conductor. The addition of the ferrite core to the probe cable rarely affects the signal because the signal passes through the core on the center conductor and returns through the core on the shield, resulting in no net signal current flowing through the core.

The position of the ferrite core on the cable is important. For convenience, you may be tempted to place the core at the scope end. This would make the probe head lighter and easier to handle. However, the core's effectiveness would be reduced substantially by locating the core at the scope interface end of the cable.

Reducing the length of the ground lead on a single-ended probe will help some. Switching to a differential probe will typically help the most. Many users don't understand that the probe cable environment can cause variations in their measurements, especially at higher frequencies, and this can lead to frustration with the repeatability and quality of measurements.



Figure 7-1. Using a ferrite core on the probe cable may help improve probing accuracy.



## Hint #8

### Damp the resonance

The performance of a probe is highly affected by the probe connection. As the speeds in your design increase, you may notice more overshoot, ringing, and other perturbations when connecting an oscilloscope probe. Probes form a resonant circuit where they connect to the device. If this resonance is within the bandwidth of the oscilloscope probe you are using, it will be difficult to determine if the measured perturbations are due to your circuit or the probe.

If you have to add wires to the tip of a probe to make a measurement in a tight environment, put a resistor at the tip to damp the resonance of the added wire.

For a single-ended probe, put the resistance only on the signal lead and try to keep the ground lead as short as possible. For a differential probe, put resistors at the tip of both leads and keep the lead lengths the same. The value of the resistor can be determined by first probing a known step signal through a fixture board like the Keysight E2655C into a scope channel. Then probe the signal with your proposed wire with a resistor at the tip. When the resistance value is right, you should see a step shaped much like the test step, except it may be low-pass filtered. If you see excessive ringing, increase the resistor value.

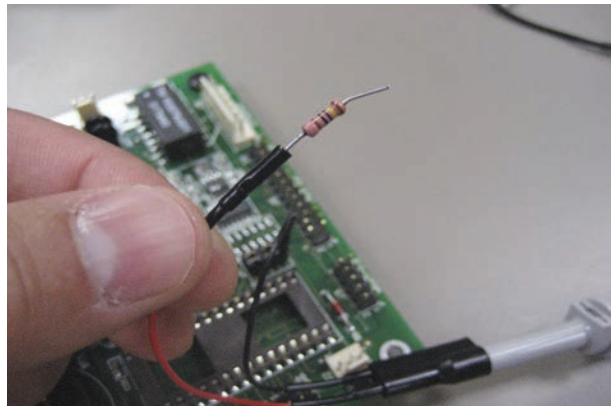

Figure 8-1. Put a resistor at the tip to damp the resonance of the added wire.

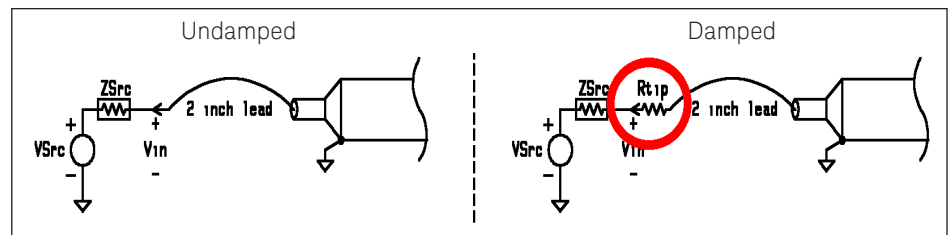

Figure 8-2. With a properly damped probe input, the loading/input impedance will never drop below the value of the damping resistor.

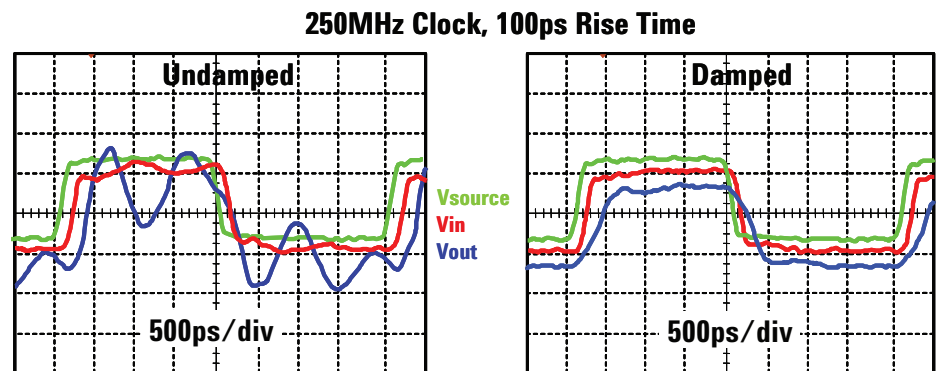

Figure 8-3. As the speeds in your design increase, you may notice more overshoot, ringing and other perturbations. Overcome the resonance formed by the connection of a probe by adding a damp resistor to your probe tip.



## Hint #8 (Continued)

### Damp the resonance

This probe's damped accessories give a flexible use model that maintains low input capacitance and inductance and flat frequency response through its specified bandwidth. The InfiniiMode N2750A Series, 1156A-58A Series and InfiniiMax Series probes use this damped accessory technology for optimum, but flexible performance.

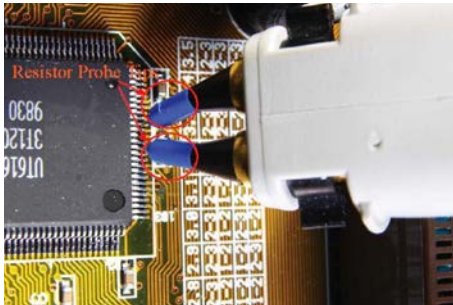
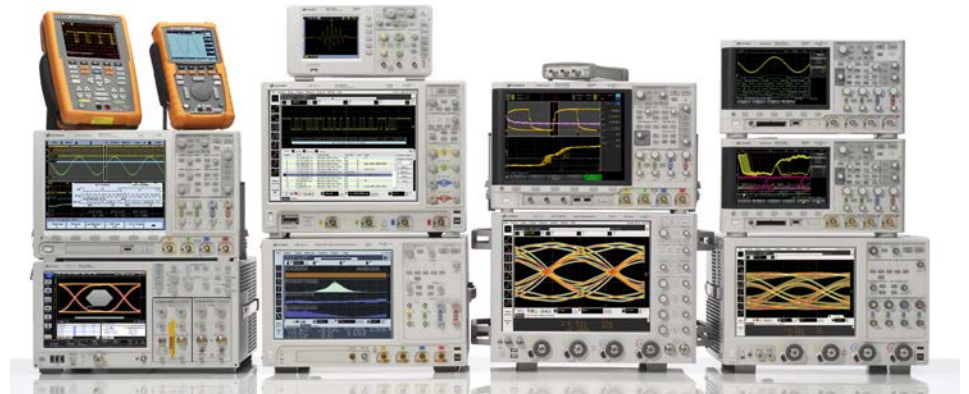

Figure 8-4. The InfiniiMode N2750A Series, 1156A-58A Series and InfiniiMax Series probes use this damped accessory technology for optimum, but flexible performance.

### Reliable measurements start with the probe! Related Keysight literature

Publication title	Publication number
Oscilloscope Probes and Accessories - Selection Guide	5989-6162EN
Infiniium Oscilloscope Probes and Accessories - Data Sheet	5968-7141EN
InfiniiVision Oscilloscope Probes and Accessories - Selection Guide	5968-8153EN

To get the most out of your oscilloscope, you need the right probes and accessories for your particular applications. Please call the measurement specialists at Keysight or visit [www.keysight.com/find/scope\\_probes](http://www.keysight.com/find/scope_probes) for information on our comprehensive array of scope probes and accessories.



## Keysight Oscilloscopes

Multiple form factors from 20 MHz to > 90 GHz | Industry leading specs | Powerful applications







**[www.axistandard.org](http://www.axistandard.org)**

AdvancedTCA® Extensions for Instrumentation and Test (AXIe) is an open standard that extends the AdvancedTCA for general purpose and semiconductor test. The business that became Keysight was a founding member of the AXIe consortium. ATCA®, AdvancedTCA®, and the ATCA logo are registered US trademarks of the PCI Industrial Computer Manufacturers Group.



**[www.lxistandard.org](http://www.lxistandard.org)**

LAN eXtensions for Instruments puts the power of Ethernet and the Web inside your test systems. The business that became Keysight was a founding member of the LXI consortium.



**[www.pxisa.org](http://www.pxisa.org)**

PCI eXtensions for Instrumentation (PXI) modular instrumentation delivers a rugged, PC-based high-performance measurement and automation system.



## Evolving Since 1939

Our unique combination of hardware, software, services, and people can help you reach your next breakthrough. We are unlocking the future of technology.

From Hewlett-Packard to Agilent to Keysight.

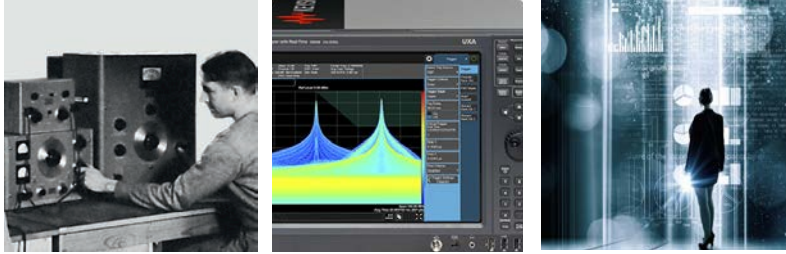

### myKeysight

#### myKeysight

[www.keysight.com/find/mykeysight](http://www.keysight.com/find/mykeysight)

A personalized view into the information most relevant to you.

[http://www.keysight.com/find/emt\\_product\\_registration](http://www.keysight.com/find/emt_product_registration)

Register your products to get up-to-date product information and find warranty information.



#### Keysight Services

[www.keysight.com/find/service](http://www.keysight.com/find/service)

Keysight Services can help from acquisition to renewal across your instrument's lifecycle. Our comprehensive service offerings—one-stop calibration, repair, asset management, technology refresh, consulting, training and more—helps you improve product quality and lower costs.



#### Keysight Assurance Plans

[www.keysight.com/find/AssurancePlans](http://www.keysight.com/find/AssurancePlans)

Up to ten years of protection and no budgetary surprises to ensure your instruments are operating to specification, so you can rely on accurate measurements.

#### Keysight Channel Partners

[www.keysight.com/find/channelpartners](http://www.keysight.com/find/channelpartners)

Get the best of both worlds: Keysight's measurement expertise and product breadth, combined with channel partner convenience.

For more information on Keysight Technologies' products, applications or services, please contact your local Keysight office. The complete list is available at:

[www.keysight.com/find/contactus](http://www.keysight.com/find/contactus)

#### Americas

Canada	(877) 894 4414
Brazil	55 11 3351 7010
Mexico	001 800 254 2440
United States	(800) 829 4444

#### Asia Pacific

Australia	1 800 629 485
China	800 810 0189
Hong Kong	800 938 693
India	1 800 11 2626
Japan	0120 (421) 345
Korea	080 769 0800
Malaysia	1 800 888 848
Singapore	1 800 375 8100
Taiwan	0800 047 866
Other AP Countries	(65) 6375 8100

#### Europe & Middle East

Austria	0800 001122
Belgium	0800 58580
Finland	0800 523252
France	0805 980333
Germany	0800 6270999
Ireland	1800 832700
Israel	1 809 343051
Italy	800 599100
Luxembourg	+32 800 58580
Netherlands	0800 0233200
Russia	8800 5009286
Spain	800 000154
Sweden	0200 882255
Switzerland	0800 805353
	Opt. 1 (DE)
	Opt. 2 (FR)
	Opt. 3 (IT)
United Kingdom	0800 0260637

For other unlisted countries:

[www.keysight.com/find/contactus](http://www.keysight.com/find/contactus)  
(BP-9-7-17)



[www.keysight.com/go/quality](http://www.keysight.com/go/quality)

Keysight Technologies, Inc.  
DEKRA Certified ISO 9001:2015  
Quality Management System

This information is subject to change without notice.

© Keysight Technologies, 2011 - 2017  
Published in USA, November 23, 2017  
5989-7894EN

[www.keysight.com](http://www.keysight.com)

