



RX 7890-RX 7891

ERGO™ Snipe Nose Pliers with Dual-Component Synthetic Handle





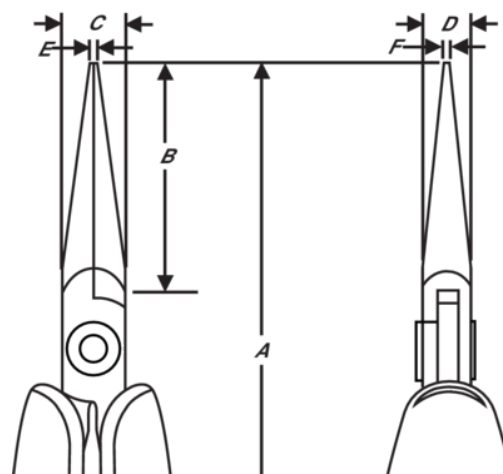

PRODUCT DETAILS

- Precision snipe nose pliers developed according to the scientific ERGO™ process
- ESD safe ERGO™ handles with two-component combination, thermoplastic surface for comfortable grip, on tough polypropylene core for rigidity
- Micro-Touch: the shape of the handles makes it possible to control & rotate the pliers between thumb & index finger for precision work
- High-performance alloyed steel
- Polished finish
- Bio spring limits the tension throughout the working cycle of the tool & can be adjusted to 3 different positions or removed
- Numerically controlled machine grinding guarantees accuracy & increases the tool's reliability & consistency
- Tough, hardened 42-46 HRC
- Screw joint minimises friction & maximises jaw alignment
- 32 mm jaws with radiused edges
- RX 7890 with smooth jaws
- RX 7891 with serrated jaws







PRODUCT ATTRIBUTES

Product: **RX 7890**

	Chain Nose		S	A	158.5 mm
A	6.24 in	B	32 mm	B	1,26 in
C	9 mm	C	0.35 in	D	6 mm
D	0,24 inch	E	1,2 mm	E	0,05 in
F	0,8 mm	F	0,03 in		Smooth
	72 g				

Product: **RX 7891**

	Chain Nose		S	A	158.5 mm
A	6.24 in	B	32 mm	B	1,26 in
C	9 mm	C	0.35 in	D	6 mm
D	0,24 inch	E	1,2 mm	E	0,05 in
F	0,8 mm	F	0,03 in		Serrated
	72 g				