

## 5 GHz to 30 GHz, GaAs, MMIC, Double Balanced Mixer

### FEATURES

- ▶ Conversion loss (downconverter): 7 dB typical at 15 GHz to 30 GHz
- ▶ Input IP3 (downconverter): 27 dBm typical at 15 GHz to 30 GHz
- ▶ Input IP2 (upconverter): 50 dBm typical at 15 GHz to 30 GHz
- ▶ Input 1 dB compression point (downconverter): 17 dBm typical
- ▶ LO to RF isolation: 40 dB typical
- ▶ LO to IF isolation: 50 dB typical at 15 GHz to 30 GHz
- ▶ RF to IF isolation: 25 dB typical at 15 GHz to 30 GHz
- ▶ 18-terminal, RoHS compliant, 4 mm × 4 mm LGA package

### APPLICATIONS

- ▶ Microwave and very small aperture terminal (VSAT) radios
- ▶ Test equipment
- ▶ Military electronic warfare (EW)
- ▶ Electronic countermeasure (ECM)
- ▶ Command, control, communications, and intelligence (C3I)

### FUNCTIONAL BLOCK DIAGRAM

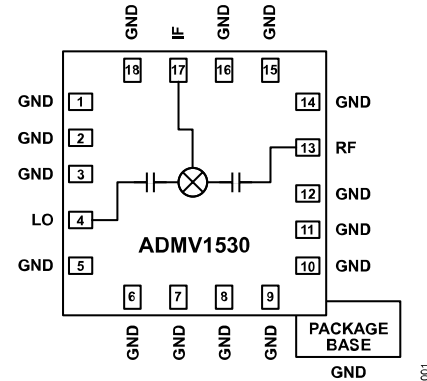

Figure 1. Functional Block Diagram

### GENERAL DESCRIPTION

The ADMV1530 is a general-purpose, double balanced mixer in a leadless, RoHS compliant, surface-mount technology (SMT) package that can be used as an upconverter or downconverter between 5 GHz and 30 GHz. The wide bandwidth from 0 GHz to 10 GHz on the intermediate frequency (IF) port allows for flexible frequency planning to avoid spurious products. This mixer is fabricated in a gallium arsenide (GaAs), monolithic microwave integrated circuit (MMIC) process and requires no external components or matching circuitry.

The ADMV1530 provides excellent local oscillator (LO) to RF and LO to IF suppression due to optimized balun structures. The mixer operates with a typical LO amplitude of 19 dBm. The RoHS-compliant ADMV1530 eliminates the need for wire bonding, allowing the use of surface-mount manufacturing techniques.

The ADMV1530 is available in a compact, 4 mm × 4 mm, 18-terminal land grid array (LGA) package and operates over a -40°C to +85°C temperature range.

**TABLE OF CONTENTS**

Features.....	1	Upconverter Performance, IF = 1 GHz.....	18
Applications.....	1	Upconverter Performance, IF = 5 GHz.....	22
Functional Block Diagram.....	1	Upconverter Performance, IF = 10 GHz.....	26
General Description.....	1	Isolation and Return Loss.....	30
Specifications.....	3	IF Bandwidth Downconverter.....	32
Pin Configuration and Function Descriptions.....	4	IF Bandwidth Upconverter.....	34
Interface Schematics.....	4	M × N Spurious Outputs.....	36
Absolute Maximum Ratings.....	5	Theory of Operation.....	38
Thermal Resistance.....	5	Applications Information.....	39
Electrostatic Discharge (ESD) Ratings.....	5	Typical Application Circuit.....	39
Typical Performance Characteristics.....	6	Evaluation PCB Information.....	39
Downconverter Performance, IF = 1 GHz.....	6	Outline Dimensions.....	40
Downconverter Performance, IF = 5 GHz.....	10	Ordering Guide.....	40
Downconverter Performance, IF = 10 GHz.....	14	Evaluation Boards.....	40

**REVISION HISTORY****7/2023—Revision 0: Initial Version**

## SPECIFICATIONS

$T_A = 25^\circ\text{C}$ ,  $IF = 1\text{ GHz}$ , and  $LO = 19\text{ dBm}$  for the upper sideband, unless otherwise noted.

**Table 1. Specifications, 5 GHz to 15 GHz Performance**

Parameter	Symbol	Min	Typ	Max	Unit
<b>FREQUENCY RANGE</b>					
RF Pin		5		15	GHz
IF Pin		DC		10	GHz
LO Pin		5		15	GHz
<b>LO AMPLITUDE</b>					
		17	19	21	dBm
<b>RF PERFORMANCE</b>					
Downconverter					
Conversion Loss			10		dB
Input Third-Order Intercept	IP3		20		dBm
Input Second-Order Intercept	IP2		40		dBm
Input 1 dB Compression Point	P1dB		17		dBm
Upconverter					
Conversion Loss			10	12	dB
Input Third-Order Intercept	IP3	9	18		dBm
Input Second-Order Intercept	IP2		40		dBm
Input 1 dB Compression Point	P1dB		13		dBm
<b>ISOLATION</b>					
LO to IF			35		dB
RF to IF			8		dB
LO to RF		30	40		dB

**Table 2. Specifications, 15 GHz to 30 GHz Performance**

Parameter	Symbol	Min	Typ	Max	Unit
<b>FREQUENCY RANGE</b>					
RF Pin		15		30	GHz
IF Pin		DC		10	GHz
LO Pin		15		30	GHz
<b>LO AMPLITUDE</b>					
		17	19	21	dBm
<b>RF PERFORMANCE</b>					
Downconverter					
Conversion Loss			7		dB
Input Third-Order Intercept	IP3		27		dBm
Input Second-Order Intercept	IP2		50		dBm
Input 1 dB Compression Point	P1dB		17		dBm
Upconverter					
Conversion Loss			9	11	dB
Input Third-Order Intercept	IP3	18	25		dBm
Input Second-Order Intercept	IP2		60		dBm
Input 1 dB Compression Point	P1dB		13		dBm
<b>ISOLATION</b>					
LO to IF			50		dB
RF to IF			25		dB
LO to RF		25	40		dB

**PIN CONFIGURATION AND FUNCTION DESCRIPTIONS**

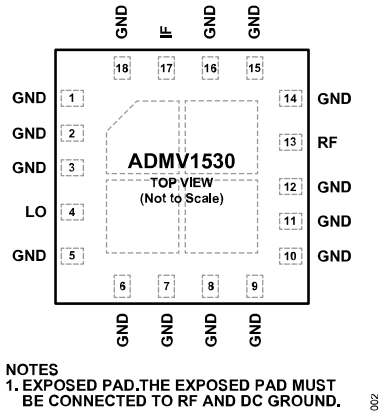

Figure 2. Pin Configuration

Table 3. Pin Function Descriptions

Pin No.	Mnemonic	Description
1 to 3, 5 to 12, 14 to 16, 18	GND	Ground. The GND pins must be connected to RF and DC ground. See Figure 3 for the interface schematic.
4	LO	LO Port. The LO pin is AC-coupled and matched to 50 Ω. See Figure 4 for the interface schematic.
13	RF	RF Port. The RF pin is AC-coupled and matched to 50 Ω. See Figure 5 for the interface schematic.
17	IF	IF Port. The IF pin is DC-coupled and matched to 50 Ω. For applications not requiring operation to DC, DC block this port externally using a series capacitor of a value chosen to pass the necessary RF frequency range. For operation to DC, the IF pin must not source or sink more than 78 mA of current. Otherwise, device malfunction or device failure may result. See Figure 6 for the interface schematic.
	EPAD	Exposed Pad. The exposed pad must be connected to RF and DC ground.

**INTERFACE SCHEMATICS**



Figure 3. GND Interface Schematic

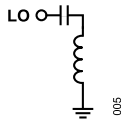

Figure 4. LO Interface Schematic

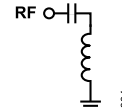

Figure 5. RF Interface Schematic

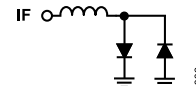

Figure 6. IF Interface Schematic

## ABSOLUTE MAXIMUM RATINGS

**Table 4. Absolute Maximum Ratings**

Parameter	Rating
RF Input Power	25 dBm
LO Input Power	25 dBm
IF Input Power	25 dBm
IF Current	78 mA
Continuous Power Dissipation, $P_{DISS}$ ( $T_A = 85^\circ\text{C}$ , Derate 4.1 mW/ $^\circ\text{C}$ Above $85^\circ\text{C}$ )	269 mW
Peak Reflow Temperature (Moisture Sensitivity Level (MSL) 3) <sup>1</sup>	260 $^\circ\text{C}$
Junction Temperature ( $T_J$ )	150 $^\circ\text{C}$
Lifetime at Maximum Temperature ( $T_J$ )	1 Million Hours
Operating Temperature Range	-40 $^\circ\text{C}$ to +85 $^\circ\text{C}$
Storage Temperature Range	-65 $^\circ\text{C}$ to +150 $^\circ\text{C}$
Lead Temperature Range	-65 $^\circ\text{C}$ to +150 $^\circ\text{C}$

<sup>1</sup> Based on IPC/JEDEC J-STD-20 MSL classifications.

Stresses at or above those listed under Absolute Maximum Ratings may cause permanent damage to the product. This is a stress rating only; functional operation of the product at these or any other conditions above those indicated in the operational section of this specification is not implied. Operation beyond the maximum operating conditions for extended periods may affect product reliability.

## THERMAL RESISTANCE

Thermal performance is directly linked to printed circuit board (PCB) design and operating environment. Careful attention to PCB thermal design is required.

$\theta_{JA}$  is the junction to ambient thermal resistance, and  $\theta_{JC}$  is the junction to case thermal resistance.

**Table 5. Thermal Resistance**

Package Type <sup>1</sup>	$\theta_{JA}$	$\theta_{JC}$	Unit
CC-18-3	64.8	241.2	$^\circ\text{C}/\text{W}$

<sup>1</sup> Thermal resistance values specified are simulated based on JEDEC specifications in compliance with JESD-51.

## ELECTROSTATIC DISCHARGE (ESD) RATINGS

The following ESD information is provided for handling of ESD-sensitive devices in an ESD protected area only.

Human body model (HBM) per ANSI/ESDA/JEDEC JS-001.

Field induced charged device model (FICDM) per ANSI/ESDA/JEDEC JS-002.

## ESD Ratings for ADMV1530

**Table 6. ADMV1530, 18-Terminal LGA**

ESD Model	Withstand Threshold (V)	Class
HBM	3000	2
FICDM	500	C2a

## ESD Caution



**ESD (electrostatic discharge) sensitive device.** Charged devices and circuit boards can discharge without detection. Although this product features patented or proprietary protection circuitry, damage may occur on devices subjected to high energy ESD. Therefore, proper ESD precautions should be taken to avoid performance degradation or loss of functionality.

TYPICAL PERFORMANCE CHARACTERISTICS

DOWNCONVERTER PERFORMANCE, IF = 1 GHz

Upper Sideband (Low-Side LO)

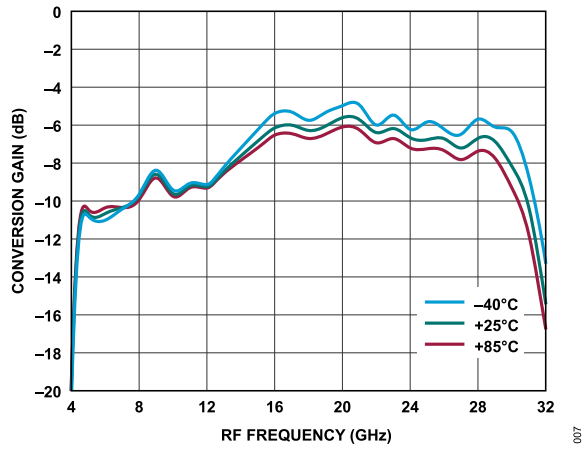

Figure 7. Conversion Gain vs. RF Frequency at Various Temperatures, LO = 19 dBm

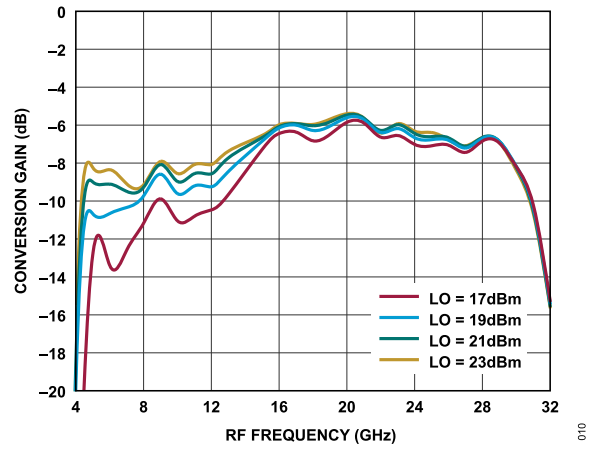

Figure 10. Conversion Gain vs. RF Frequency at Various LO Power Levels,  $T_A = 25^\circ\text{C}$

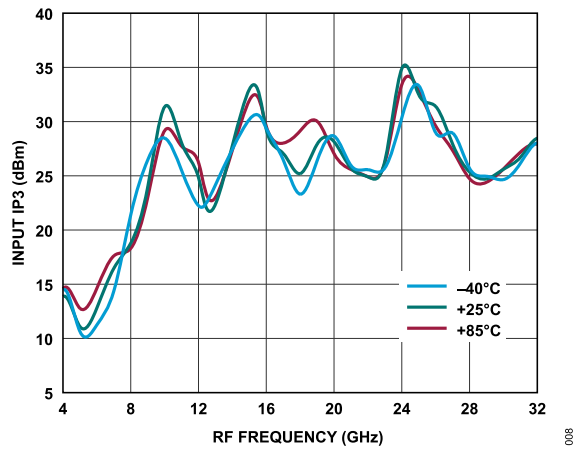

Figure 8. Input IP3 vs. RF Frequency at Various Temperatures, LO = 19 dBm

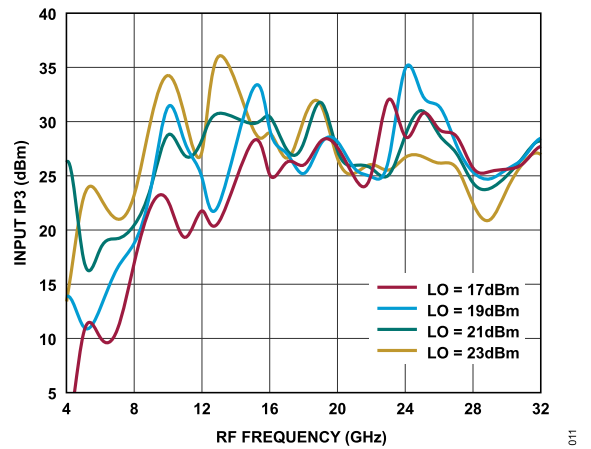

Figure 11. Input IP3 vs. RF Frequency at Various LO Power Levels,  $T_A = 25^\circ\text{C}$

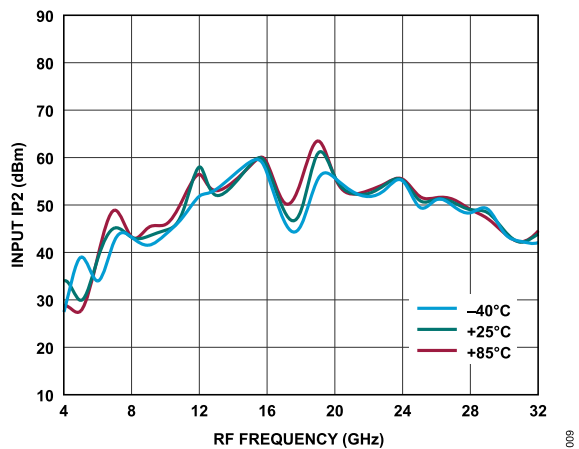

Figure 9. Input IP2 vs. RF Frequency at Various Temperatures, LO = 19 dBm

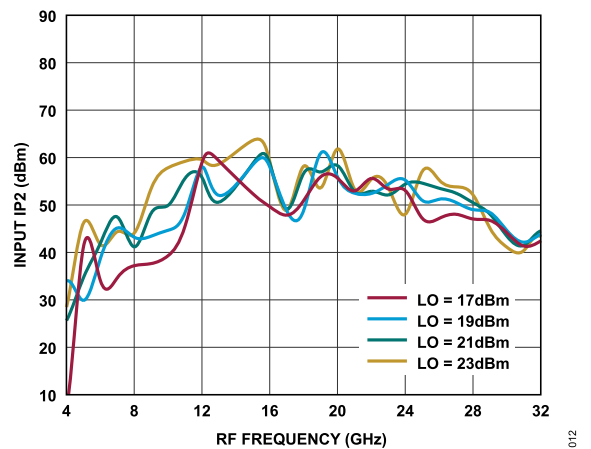

Figure 12. Input IP2 vs. RF Frequency at Various LO Power Levels,  $T_A = 25^\circ\text{C}$

TYPICAL PERFORMANCE CHARACTERISTICS

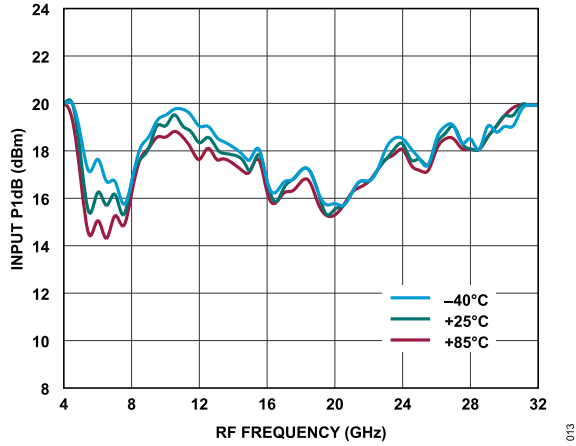

Figure 13. Input P1dB vs. RF Frequency at Various Temperatures, LO = 19 dBm

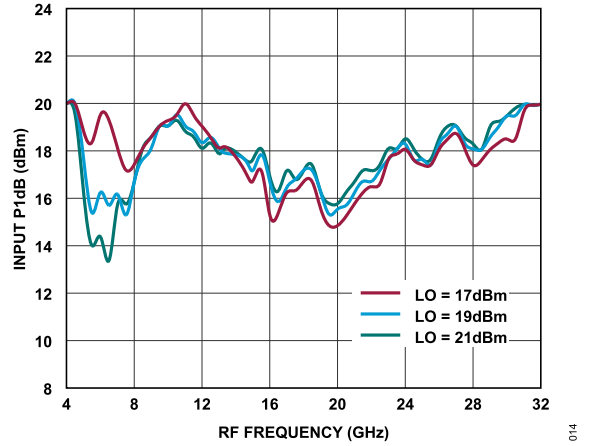

Figure 15. Input P1dB vs. RF Frequency at Various LO Power Levels,  $T_A = 25^\circ\text{C}$

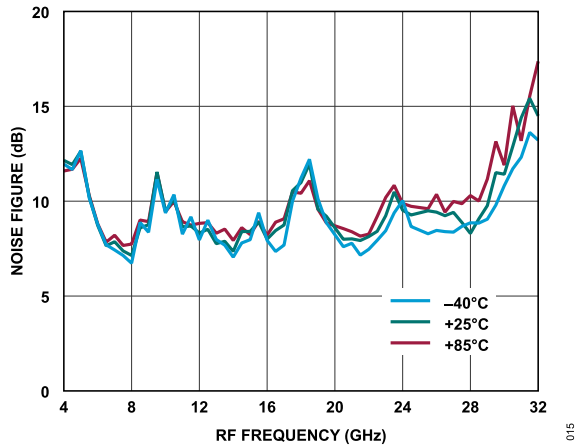

Figure 14. Noise Figure vs. RF Frequency at Various Temperatures, LO = 19 dBm

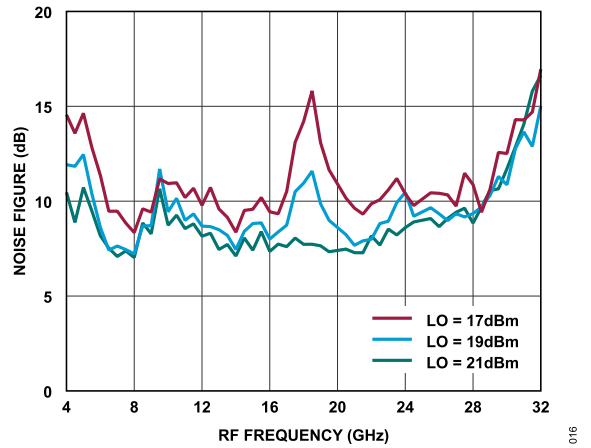

Figure 16. Noise Figure vs. RF Frequency at Various LO Power Levels,  $T_A = 25^\circ\text{C}$

TYPICAL PERFORMANCE CHARACTERISTICS

Lower Sideband (High-Side LO)

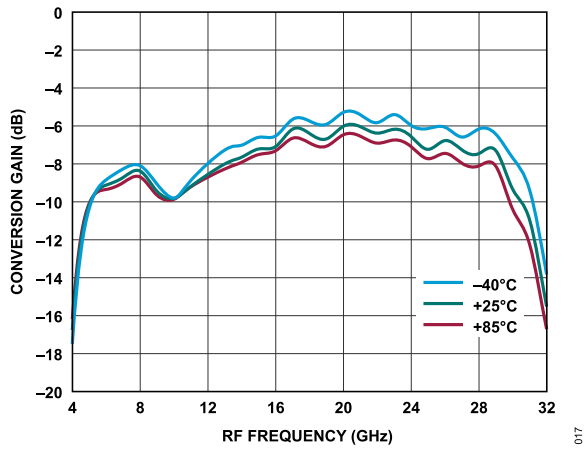

Figure 17. Conversion Gain vs. RF Frequency at Various Temperatures, LO = 19 dBm

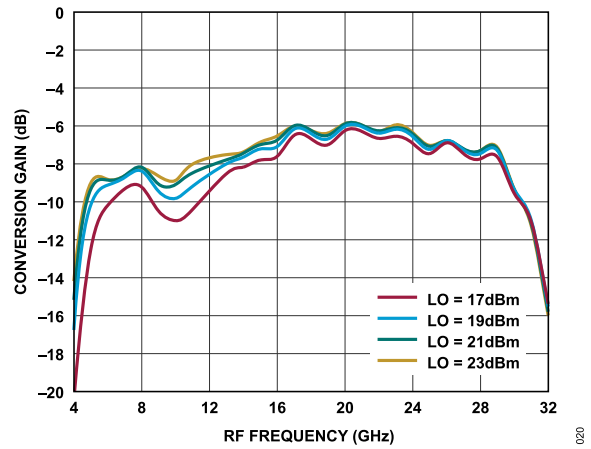

Figure 20. Conversion Gain vs. RF Frequency at Various LO Power Levels,  $T_A = 25^\circ\text{C}$

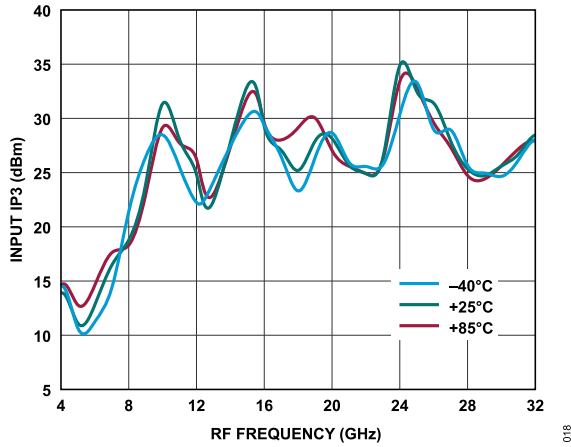

Figure 18. Input IP3 vs. RF Frequency at Various Temperatures, LO = 19 dBm

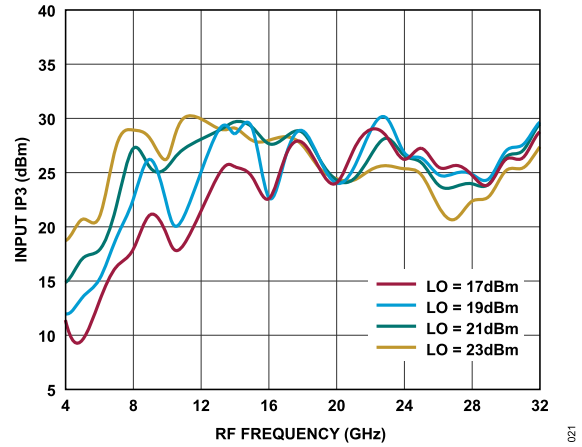

Figure 21. Input IP3 vs. RF Frequency at Various LO Power Levels,  $T_A = 25^\circ\text{C}$

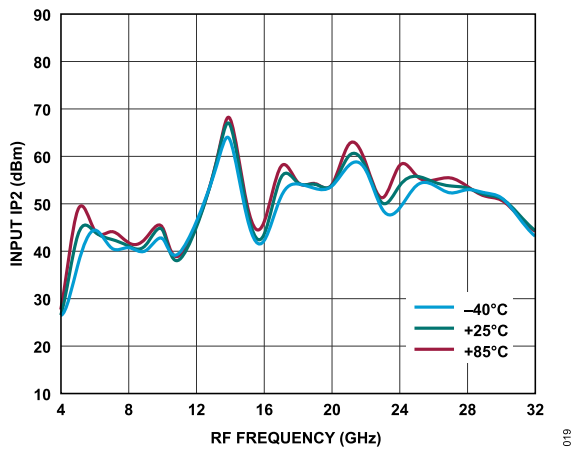

Figure 19. Input IP2 vs. RF Frequency at Various Temperatures, LO = 19 dBm

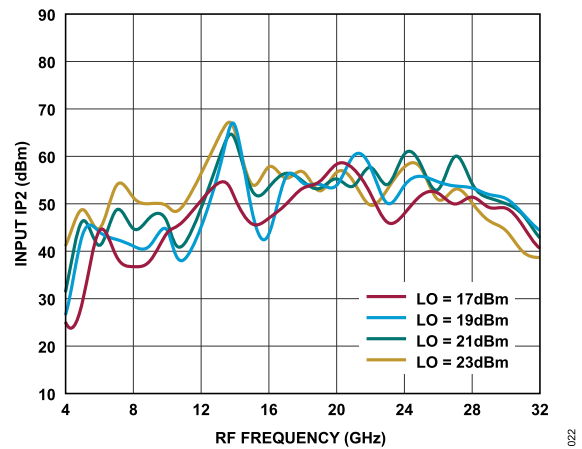

Figure 22. Input IP2 vs. RF Frequency at Various LO Power Levels,  $T_A = 25^\circ\text{C}$



TYPICAL PERFORMANCE CHARACTERISTICS

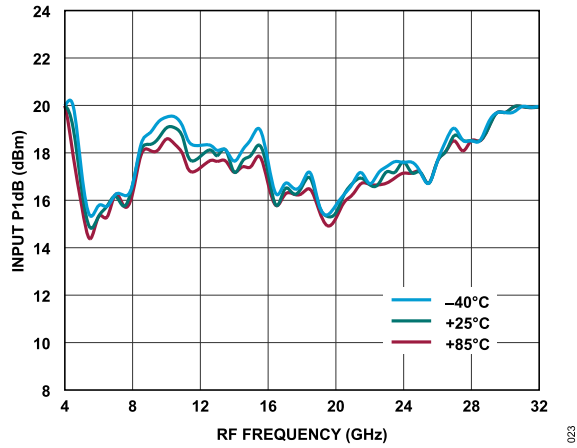

Figure 23. Input P1dB vs. RF Frequency at Various Temperatures, LO = 19 dBm

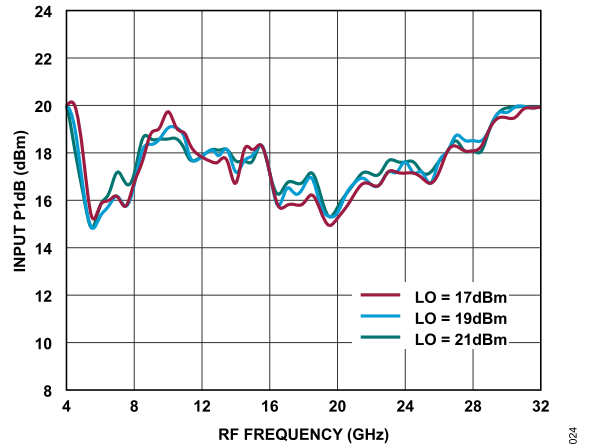

Figure 24. Input P1dB vs. RF Frequency at Various LO Power Levels,  $T_A = 25^\circ\text{C}$

TYPICAL PERFORMANCE CHARACTERISTICS

DOWNCONVERTER PERFORMANCE, IF = 5 GHz

Upper Sideband (Low-Side LO)

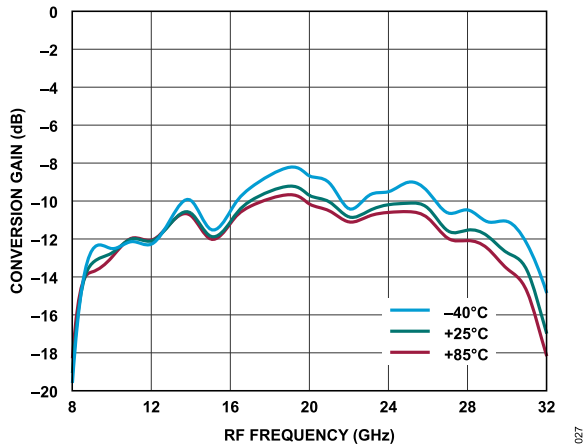

Figure 25. Conversion Gain vs. RF Frequency at Various Temperatures, LO = 19 dBm

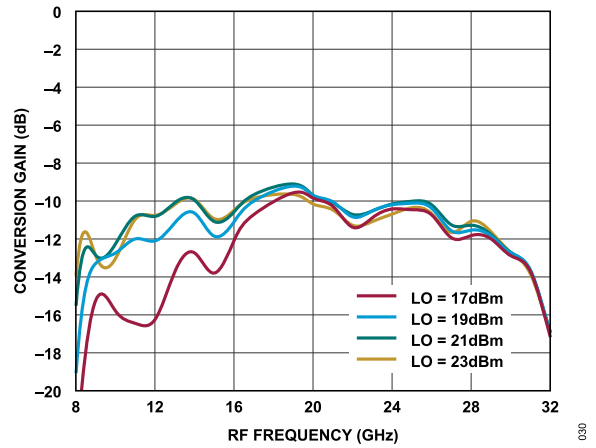

Figure 28. Conversion Gain vs. RF Frequency at Various LO Power Levels,  $T_A = 25^\circ\text{C}$

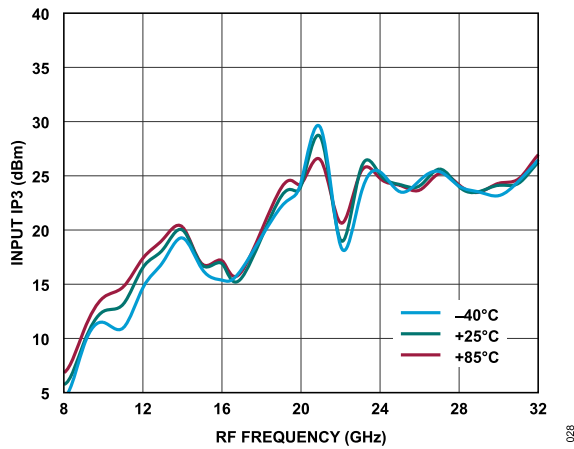

Figure 26. Input IP3 vs. RF Frequency at Various Temperatures, LO = 19 dBm

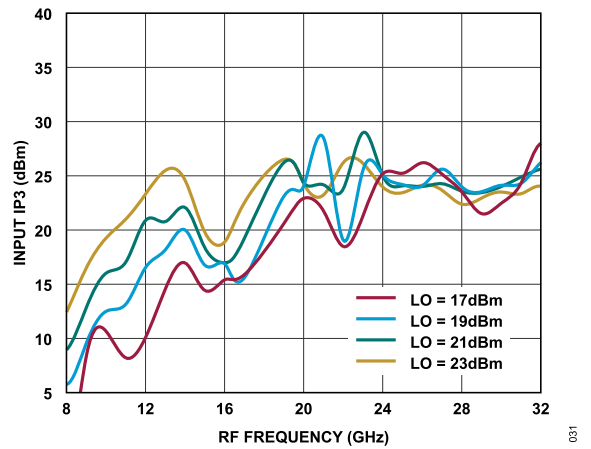

Figure 29. Input IP3 vs. RF Frequency at Various LO Power Levels,  $T_A = 25^\circ\text{C}$

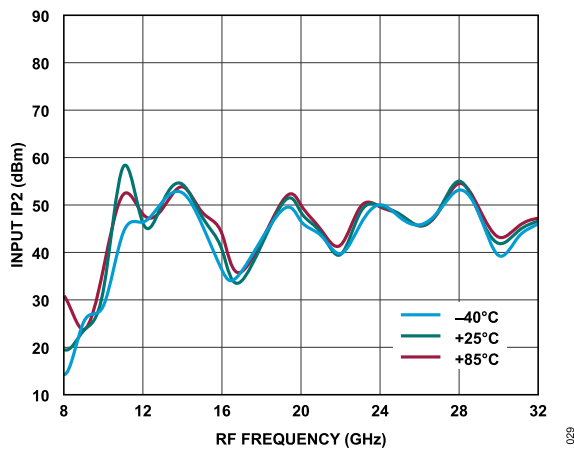

Figure 27. Input IP2 vs. RF Frequency at Various Temperatures, LO = 19 dBm

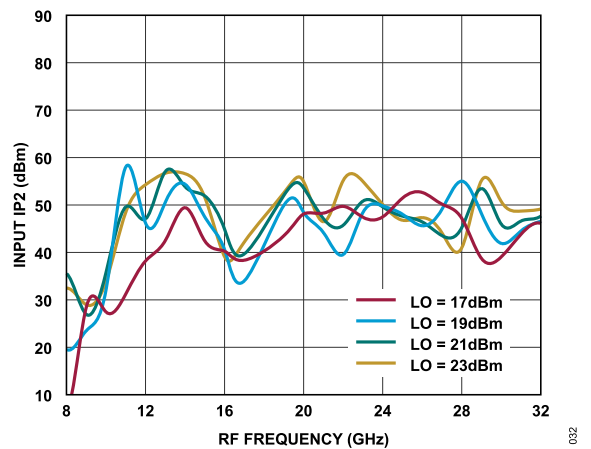

Figure 30. Input IP2 vs. RF Frequency at Various LO Power Levels,  $T_A = 25^\circ\text{C}$

TYPICAL PERFORMANCE CHARACTERISTICS

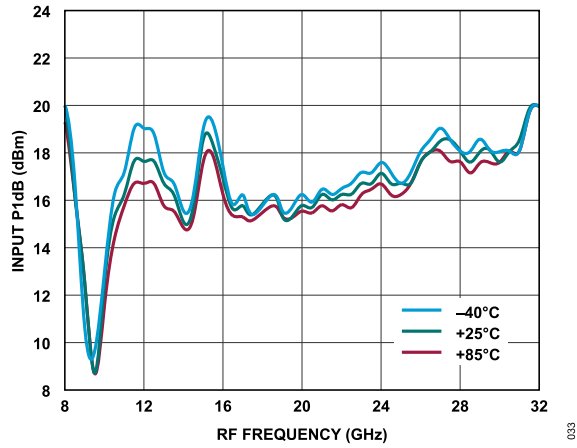

Figure 31. Input P1dB vs. RF Frequency at Various Temperatures, LO = 19 dBm

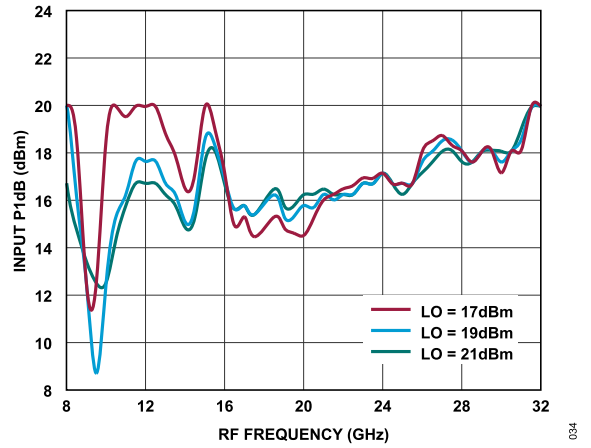

Figure 32. Input P1dB vs. RF Frequency at Various LO Power Levels,  $T_A = 25^\circ\text{C}$

TYPICAL PERFORMANCE CHARACTERISTICS

Lower Sideband (High-Side LO)

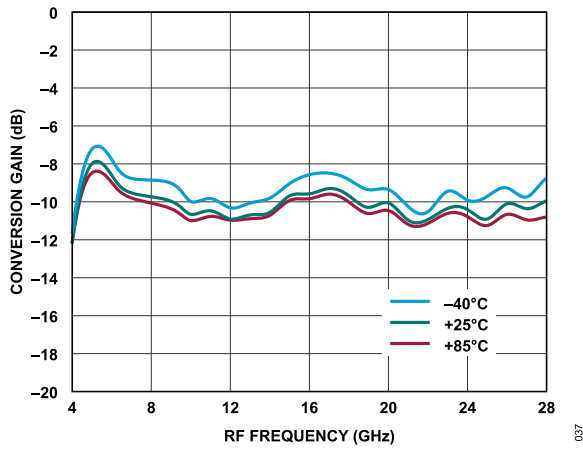

Figure 33. Conversion Gain vs. RF Frequency at Various Temperatures, LO = 19 dBm

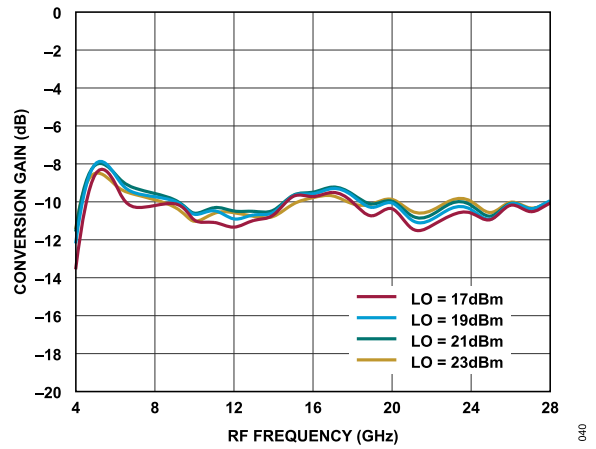

Figure 36. Conversion Gain vs. RF Frequency at Various LO Power Levels,  $T_A = 25^\circ\text{C}$

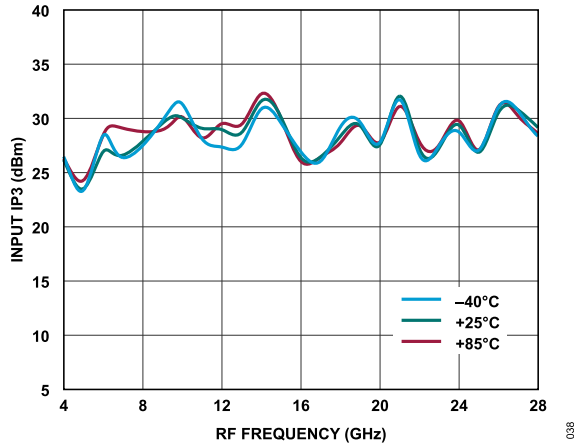

Figure 34. Input IP3 vs. RF Frequency at Various Temperatures, LO = 19 dBm

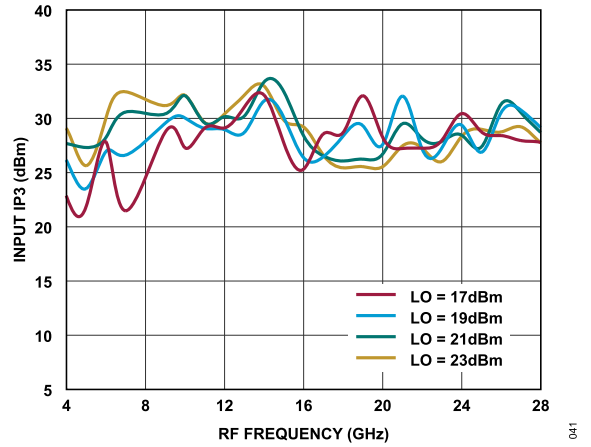

Figure 37. Input IP3 vs. RF Frequency at Various LO Power Levels,  $T_A = 25^\circ\text{C}$

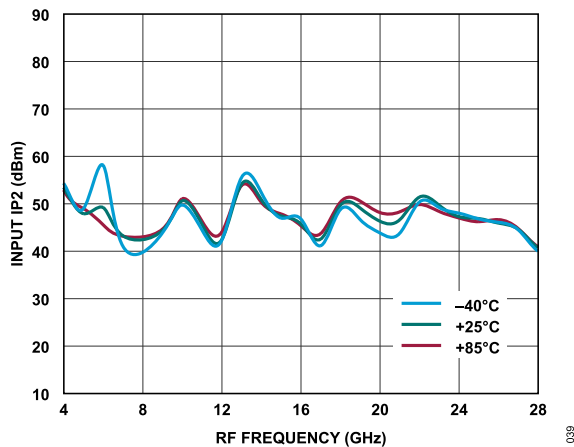

Figure 35. Input IP2 vs. RF Frequency at Various Temperatures, LO = 19 dBm

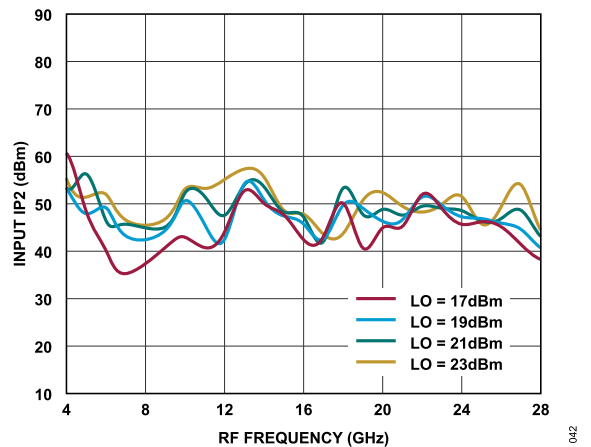

Figure 38. Input IP2 vs. RF Frequency at Various LO Power Levels,  $T_A = 25^\circ\text{C}$

TYPICAL PERFORMANCE CHARACTERISTICS

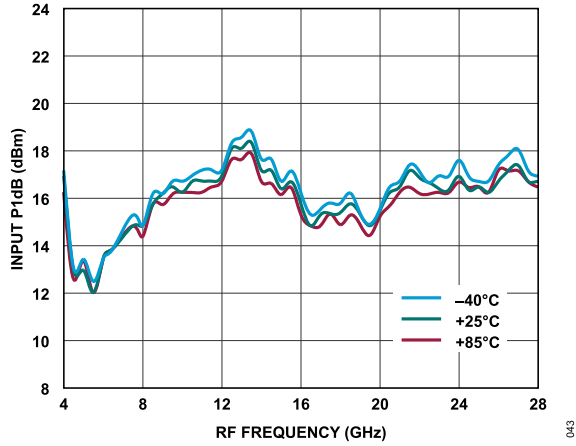

Figure 39. Input P1dB vs. RF Frequency at Various Temperatures, LO = 19 dBm

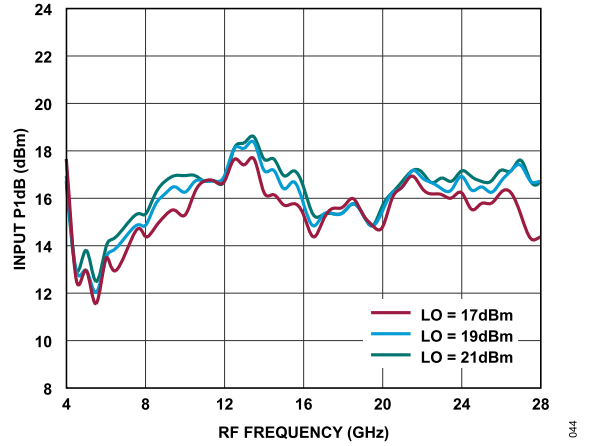

Figure 40. Input P1dB vs. RF Frequency at Various LO Power Levels,  $T_A = 25^\circ\text{C}$

TYPICAL PERFORMANCE CHARACTERISTICS

DOWNCONVERTER PERFORMANCE, IF = 10 GHz

Upper Sideband (Low-Side LO)

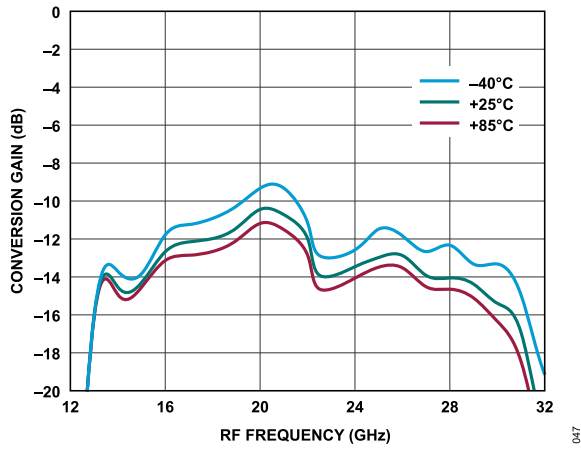

Figure 41. Conversion Gain vs. RF Frequency at Various Temperatures, LO = 19 dBm

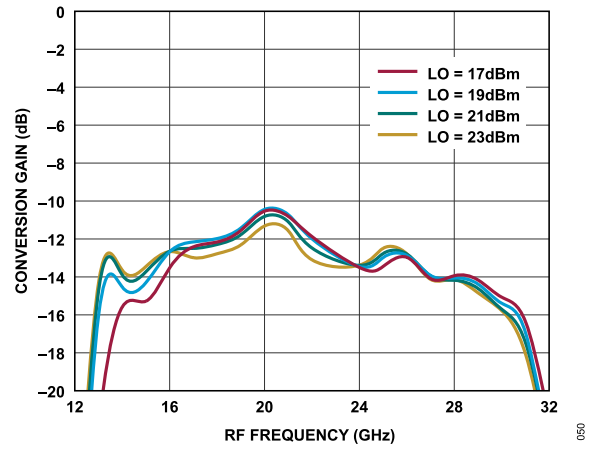

Figure 44. Conversion Gain vs. RF Frequency at Various LO Power Levels,  $T_A = 25^\circ\text{C}$

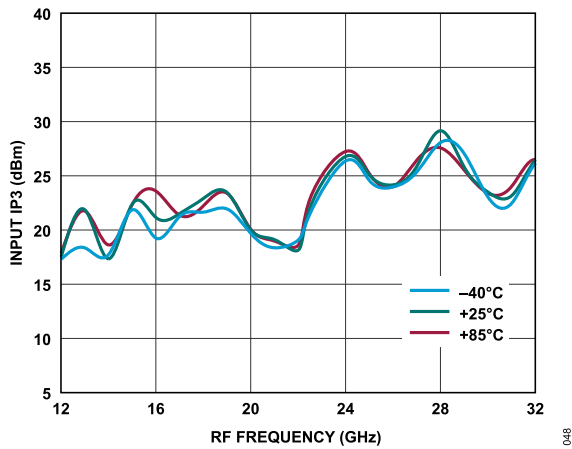

Figure 42. Input IP3 vs. RF Frequency at Various Temperatures, LO = 19 dBm

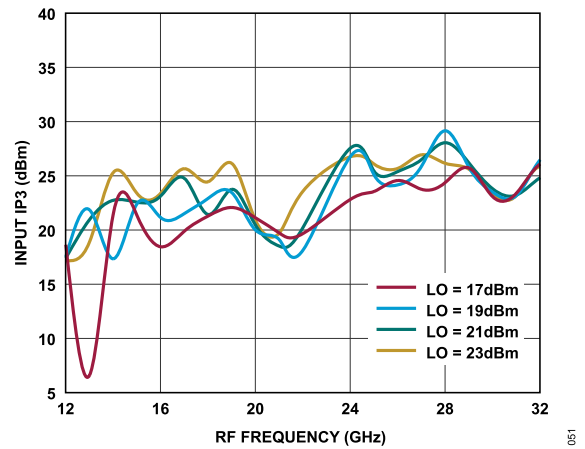

Figure 45. Input IP3 vs. RF Frequency at Various LO Power Levels,  $T_A = 25^\circ\text{C}$

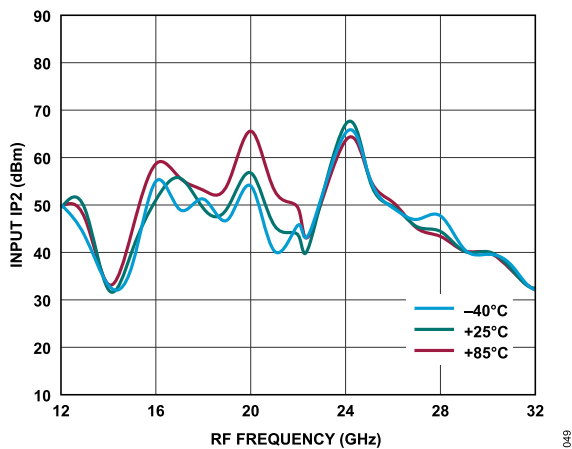

Figure 43. Input IP2 vs. RF Frequency at Various Temperatures, LO = 19 dBm

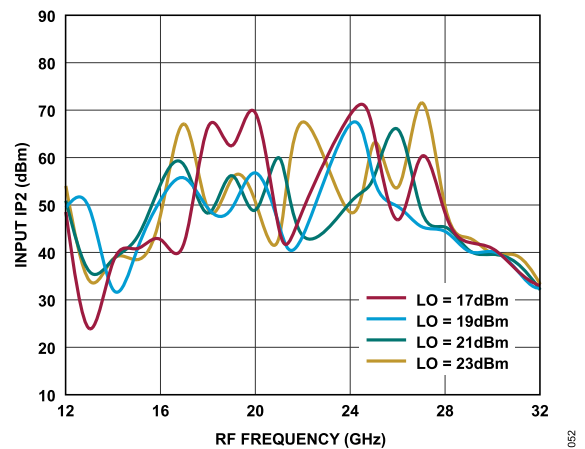

Figure 46. Input IP2 vs. RF Frequency at Various LO Power Levels,  $T_A = 25^\circ\text{C}$

TYPICAL PERFORMANCE CHARACTERISTICS

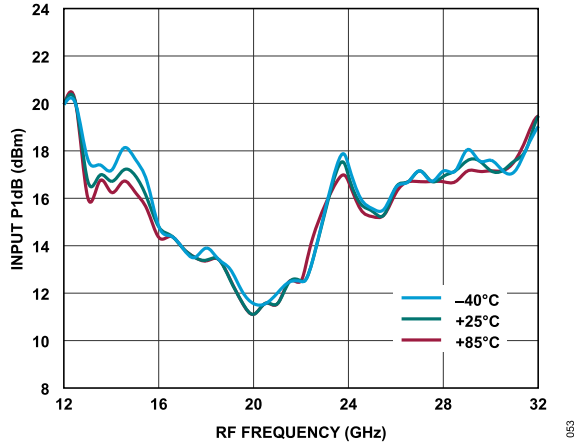

Figure 47. Input P1dB vs. RF Frequency at Various Temperatures, LO = 19 dBm

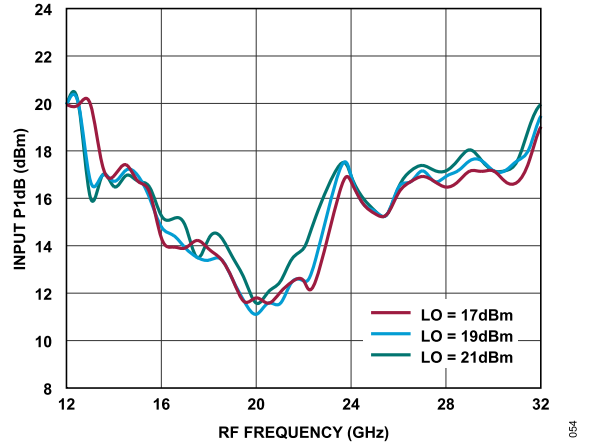

Figure 48. Input P1dB vs. RF Frequency at Various LO Power Levels, TA = 25°C

TYPICAL PERFORMANCE CHARACTERISTICS

Lower Sideband (High-Side LO)

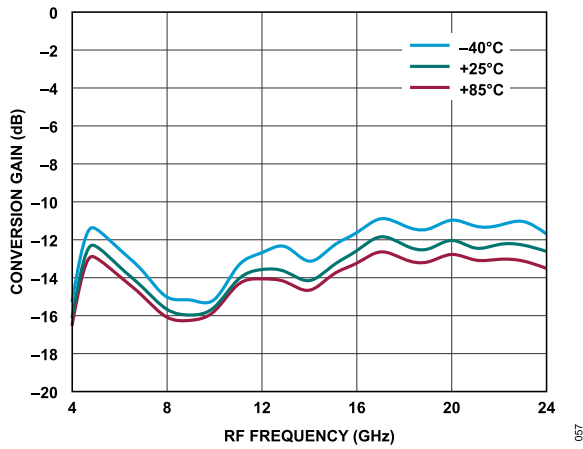

Figure 49. Conversion Gain vs. RF Frequency at Various Temperatures, LO = 19 dBm

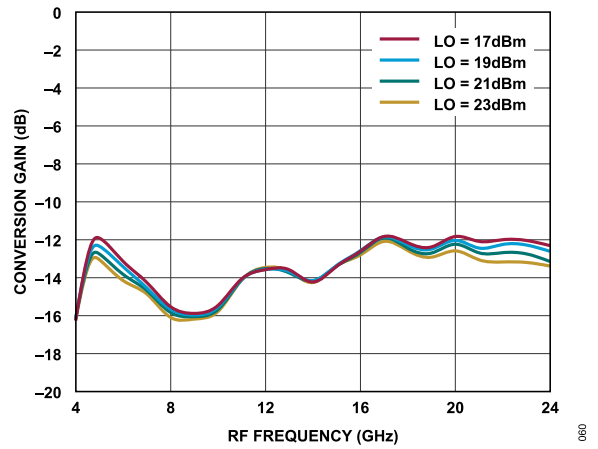

Figure 52. Conversion Gain vs. RF Frequency at Various LO Power Levels,  $T_A = 25^\circ\text{C}$

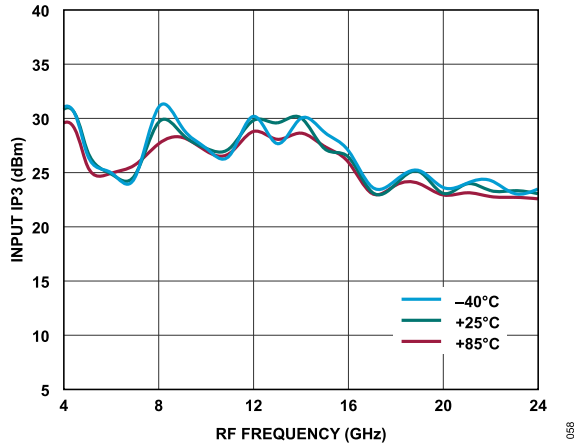

Figure 50. Input IP3 vs. RF Frequency at Various Temperatures, LO = 19 dBm

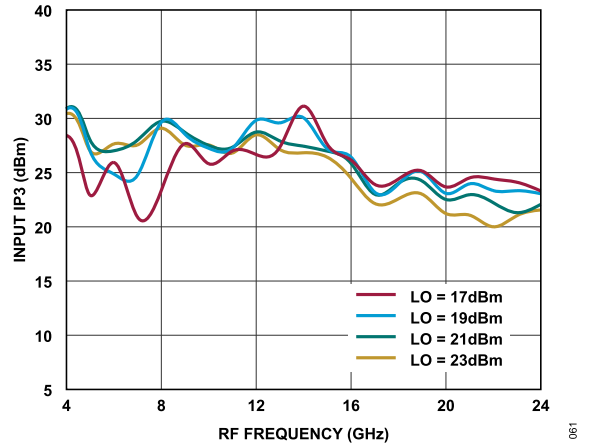

Figure 53. Input IP3 vs. RF Frequency at Various LO Power Levels,  $T_A = 25^\circ\text{C}$

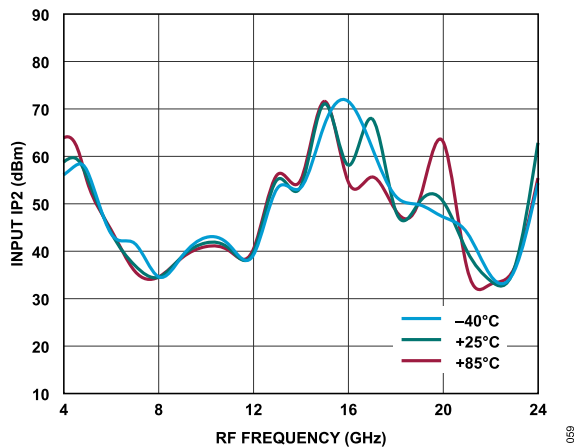

Figure 51. Input IP2 vs. RF Frequency at Various Temperatures, LO = 19 dBm

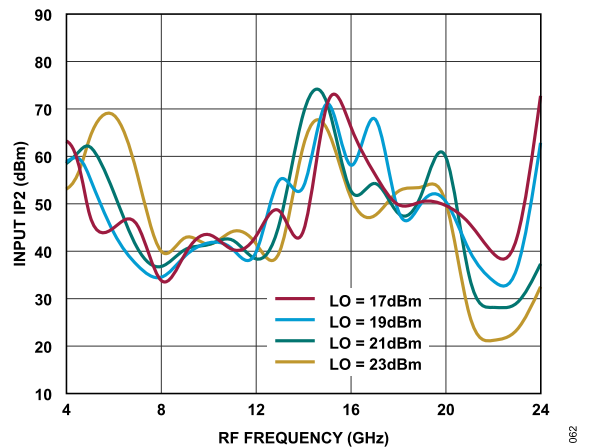

Figure 54. Input IP2 vs. RF Frequency at Various LO Power Levels,  $T_A = 25^\circ\text{C}$



TYPICAL PERFORMANCE CHARACTERISTICS

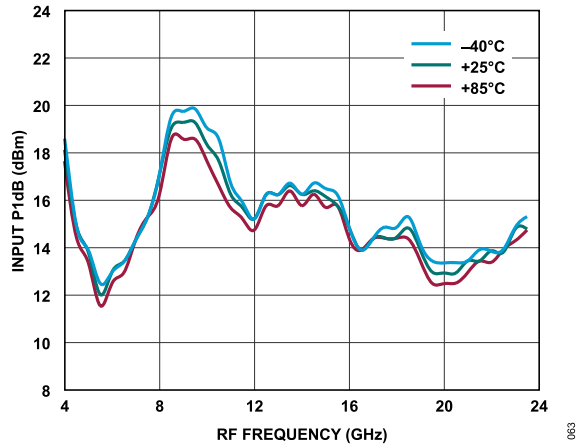

Figure 55. Input P1dB vs. RF Frequency at Various Temperatures, LO = 19 dBm

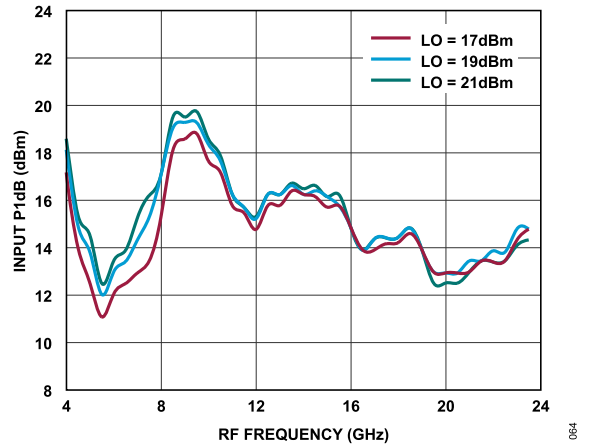

Figure 56. Input P1dB vs. RF Frequency at Various LO Power Levels, TA = 25°C

TYPICAL PERFORMANCE CHARACTERISTICS

UPCONVERTER PERFORMANCE, IF = 1 GHz

Upper Sideband (Low-Side LO)

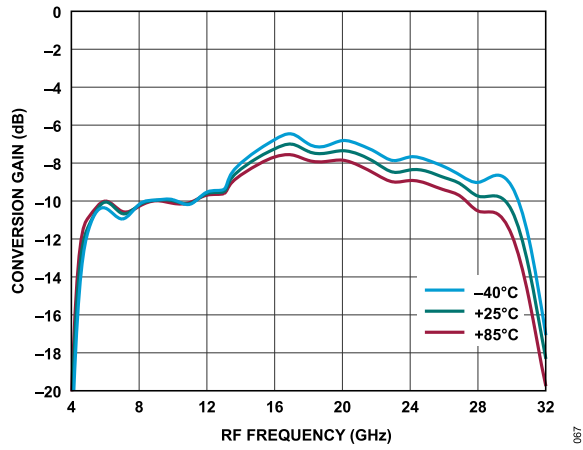

Figure 57. Conversion Gain vs. RF Frequency at Various Temperatures, LO = 19 dBm

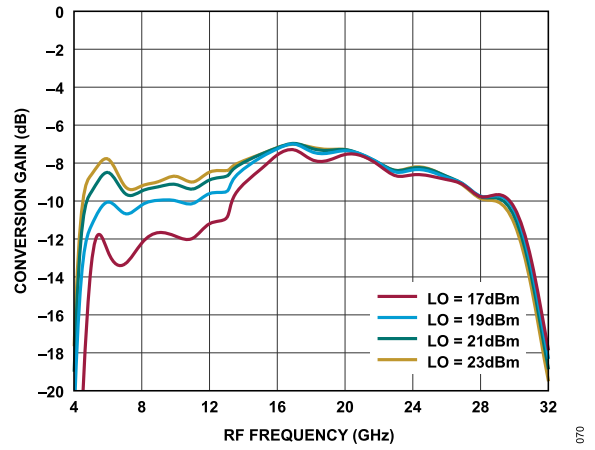

Figure 60. Conversion Gain vs. RF Frequency at Various LO Power Levels,  $T_A = 25^\circ\text{C}$

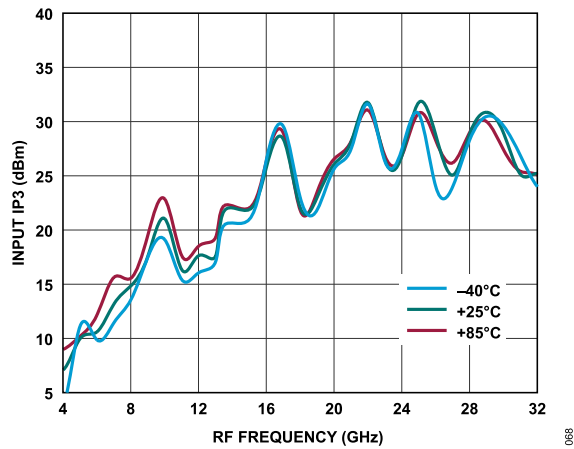

Figure 58. Input IP3 vs. RF Frequency at Various Temperatures, LO = 19 dBm

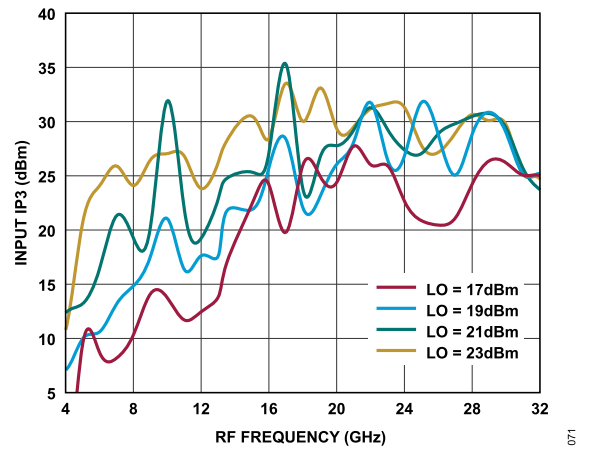

Figure 61. Input IP3 vs. RF Frequency at Various LO Power Levels,  $T_A = 25^\circ\text{C}$

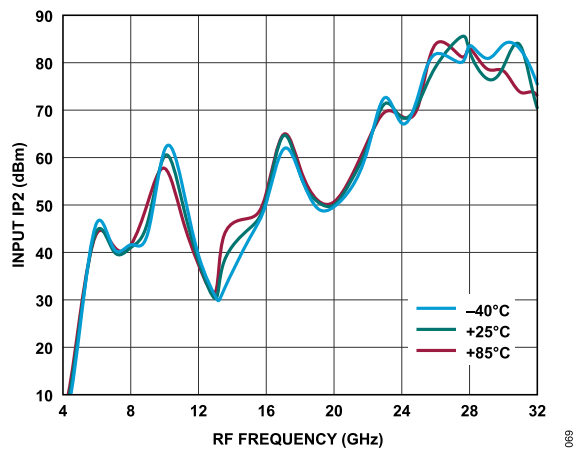

Figure 59. Input IP2 vs. RF Frequency at Various Temperatures, LO = 19 dBm

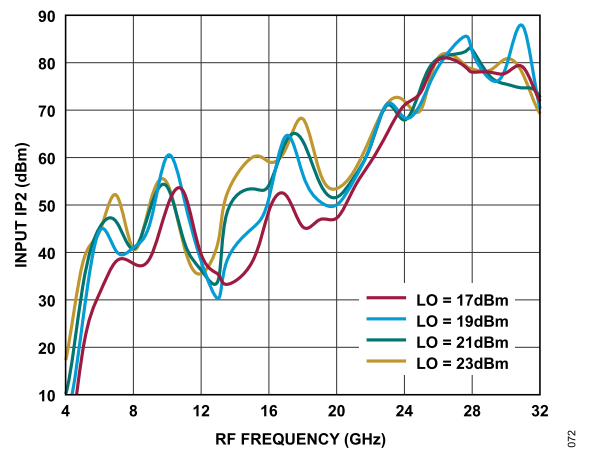

Figure 62. Input IP2 vs. RF Frequency at Various LO Power Levels,  $T_A = 25^\circ\text{C}$

TYPICAL PERFORMANCE CHARACTERISTICS

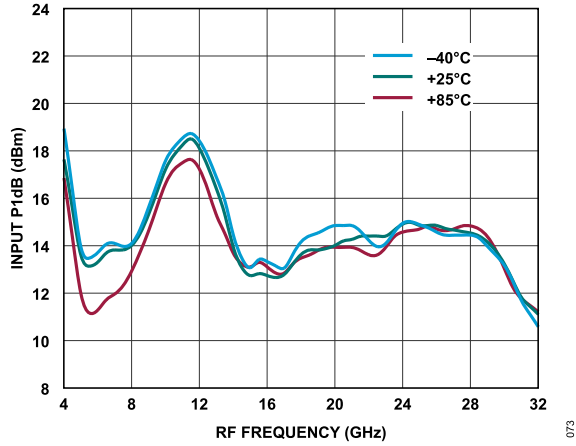

Figure 63. Input P1dB vs. RF Frequency at Various Temperatures, LO = 19 dBm

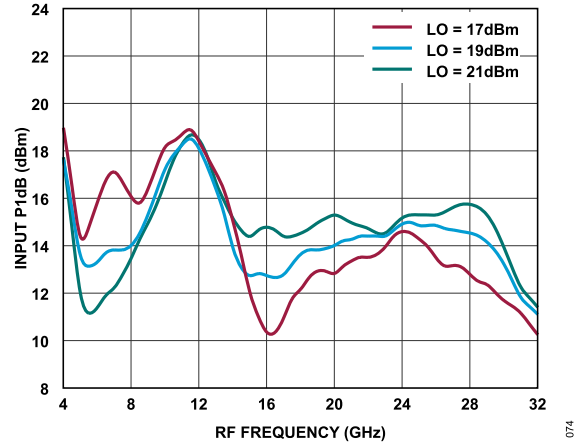

Figure 64. Input P1dB vs. RF Frequency at Various LO Power Levels, TA = 25°C

TYPICAL PERFORMANCE CHARACTERISTICS

Lower Sideband (High-Side LO)

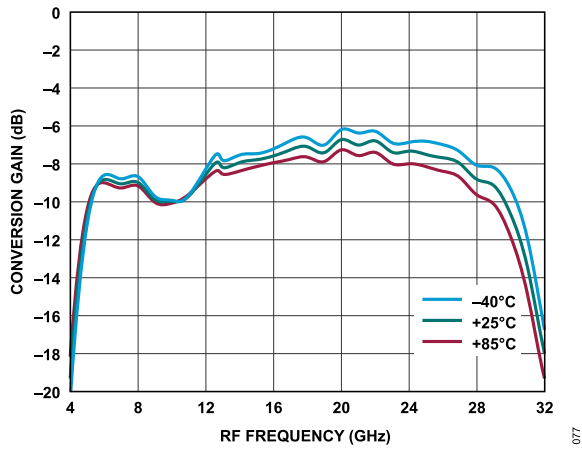

Figure 65. Conversion Gain vs. RF Frequency at Various Temperatures, LO = 19 dBm

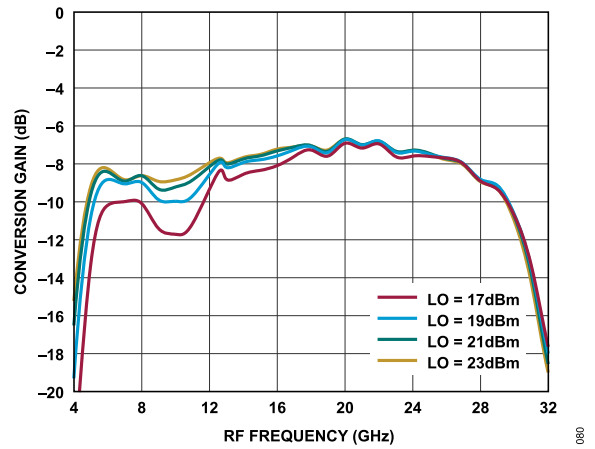

Figure 68. Conversion Gain vs. RF Frequency at Various LO Power Levels,  $T_A = 25^\circ\text{C}$

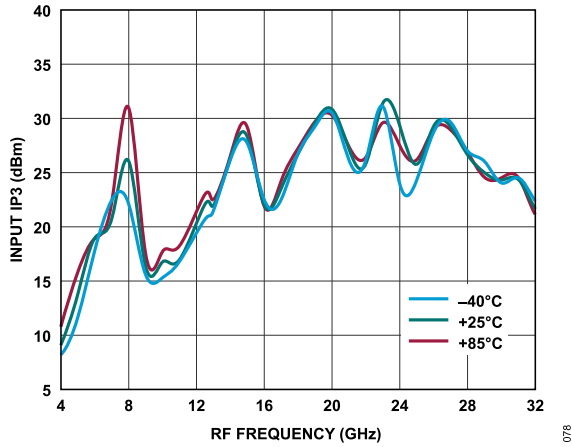

Figure 66. Input IP3 vs. RF Frequency at Various Temperatures, LO = 19 dBm

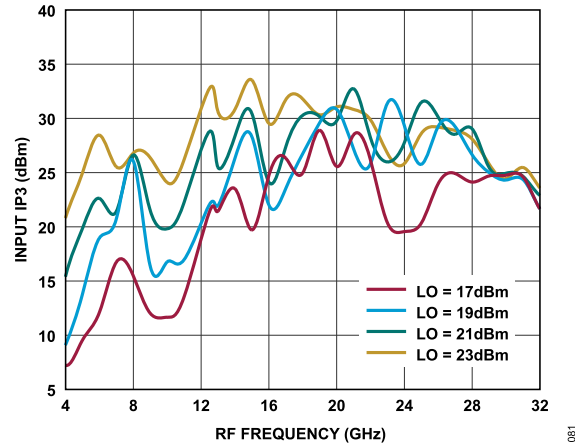

Figure 69. Input IP3 vs. RF Frequency at Various LO Power Levels,  $T_A = 25^\circ\text{C}$

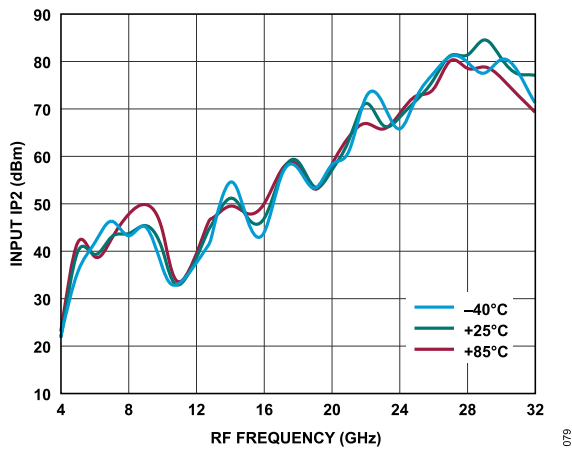

Figure 67. Input IP2 vs. RF Frequency at Various Temperatures, LO = 19 dBm

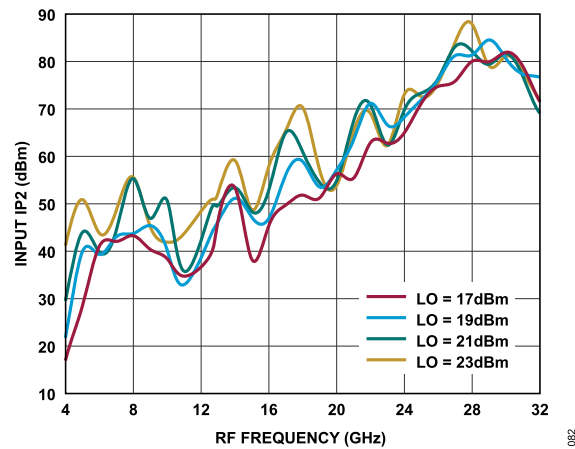

Figure 70. Input IP2 vs. RF Frequency at Various LO Power Levels,  $T_A = 25^\circ\text{C}$

TYPICAL PERFORMANCE CHARACTERISTICS

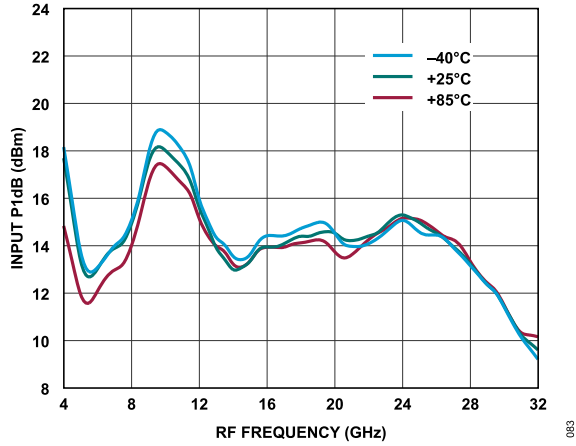

Figure 71. Input P1dB vs. RF Frequency at Various Temperatures, LO = 19 dBm

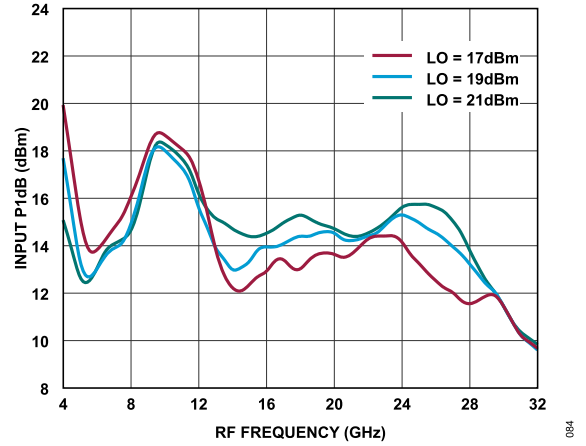

Figure 72. Input P1dB vs. RF Frequency at Various LO Power Levels, TA = 25°C

TYPICAL PERFORMANCE CHARACTERISTICS

UPCONVERTER PERFORMANCE, IF = 5 GHz

Upper Sideband (Low-Side LO)

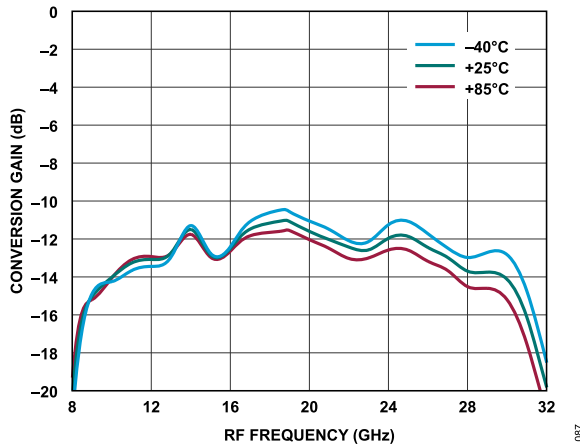

Figure 73. Conversion Gain vs. RF Frequency at Various Temperatures, LO = 19 dBm

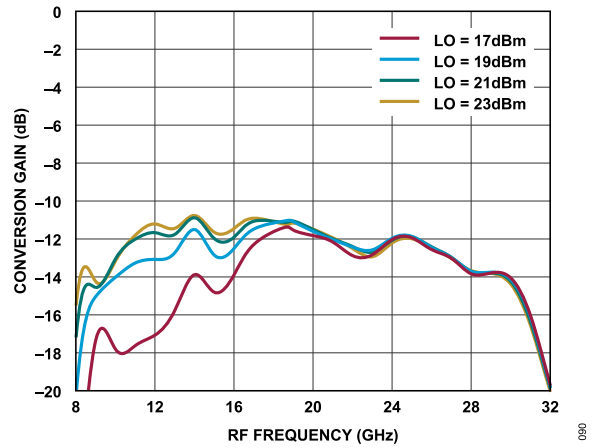

Figure 76. Conversion Gain vs. RF Frequency at Various LO Power Levels,  $T_A = 25^\circ\text{C}$

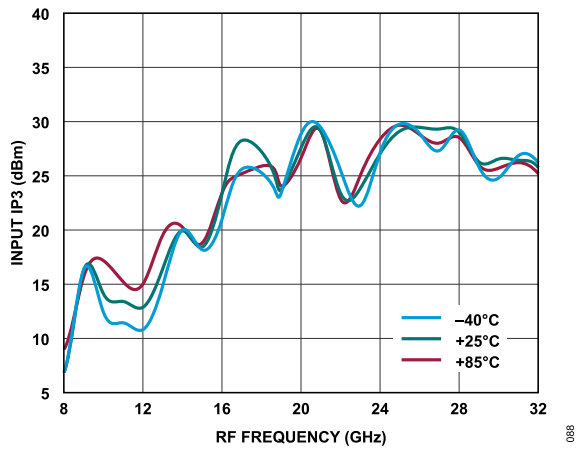

Figure 74. Input IP3 vs. RF Frequency at Various Temperatures, LO = 19 dBm

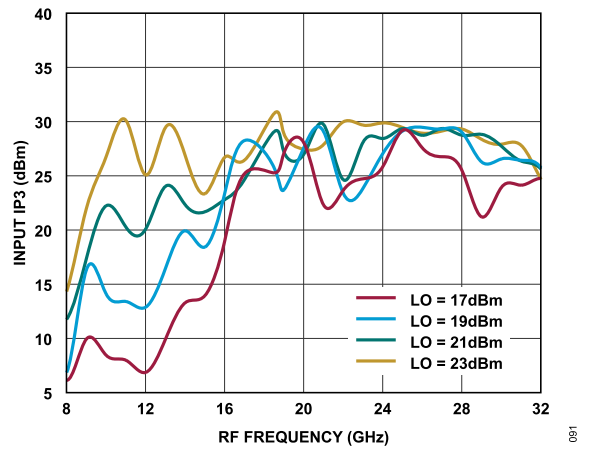

Figure 77. Input IP3 vs. RF Frequency at Various LO Power Levels,  $T_A = 25^\circ\text{C}$

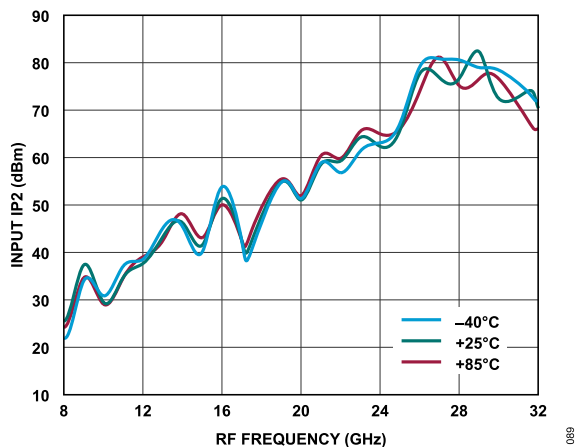

Figure 75. Input IP2 vs. RF Frequency at Various Temperatures, LO = 19 dBm

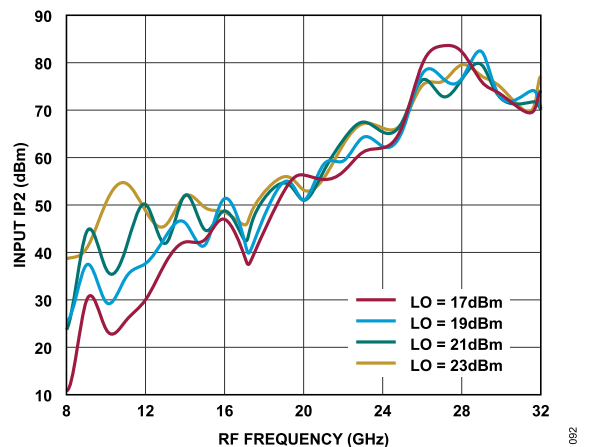

Figure 78. Input IP2 vs. RF Frequency at Various LO Power Levels,  $T_A = 25^\circ\text{C}$

TYPICAL PERFORMANCE CHARACTERISTICS

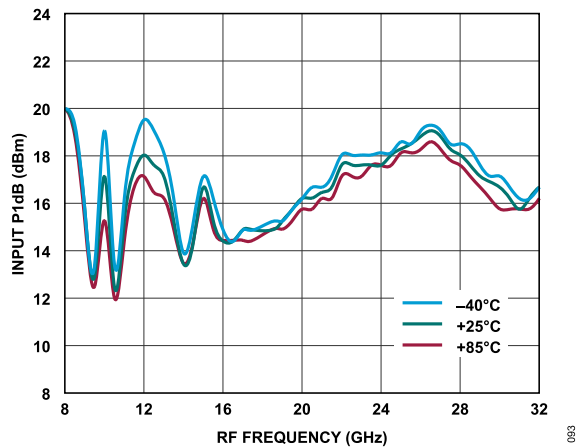

Figure 79. Input P1dB vs. RF Frequency at Various Temperatures, LO = 19 dBm

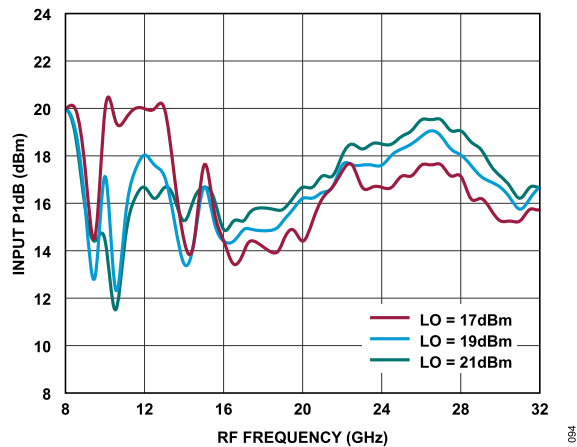

Figure 80. Input P1dB vs. RF Frequency at Various LO Power Levels,  $T_A = 25^\circ\text{C}$

TYPICAL PERFORMANCE CHARACTERISTICS

Lower Sideband (High-Side LO)

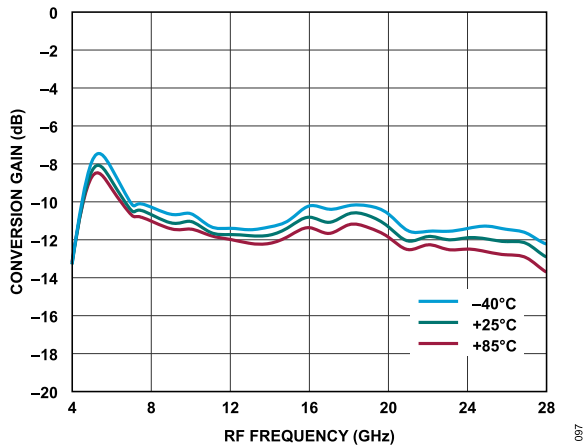

Figure 81. Conversion Gain vs. RF Frequency at Various Temperatures, LO = 19 dBm

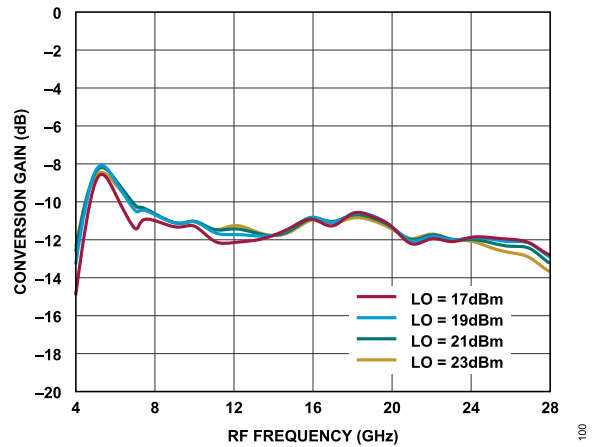

Figure 84. Conversion Gain vs. RF Frequency at Various LO Power Levels, TA = 25°C

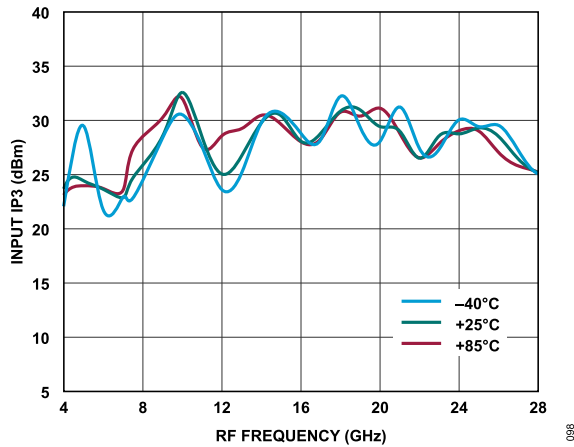

Figure 82. Input IP3 vs. RF Frequency at Various Temperatures, LO = 19 dBm

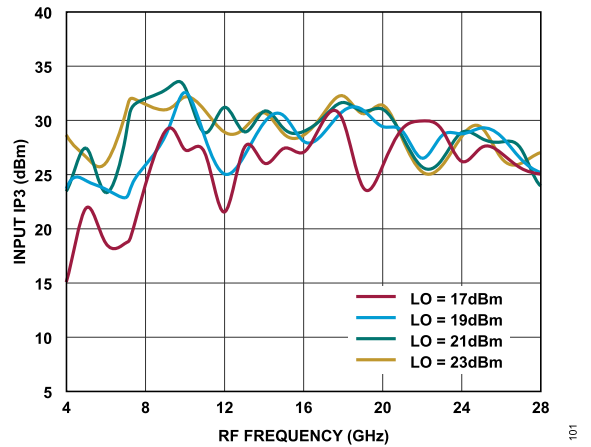

Figure 85. Input IP3 vs. RF Frequency at Various LO Power Levels, TA = 25°C

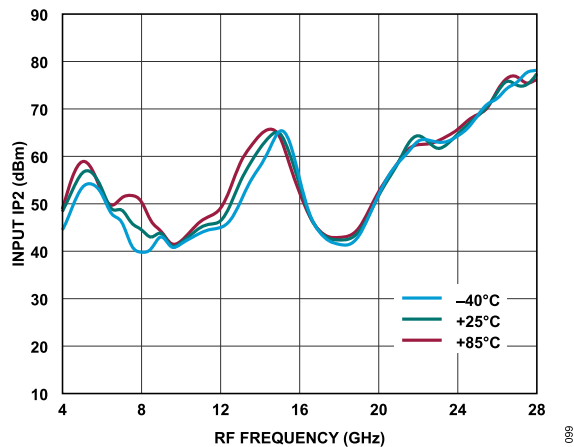

Figure 83. Input IP2 vs. RF Frequency at Various Temperatures, LO = 19 dBm

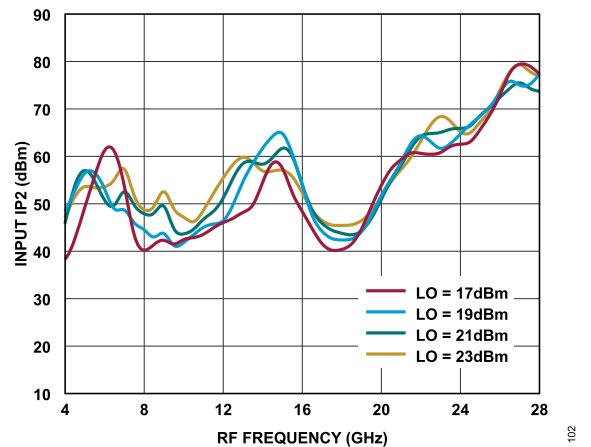

Figure 86. Input IP2 vs. RF Frequency at Various LO Power Levels, TA = 25°C



TYPICAL PERFORMANCE CHARACTERISTICS

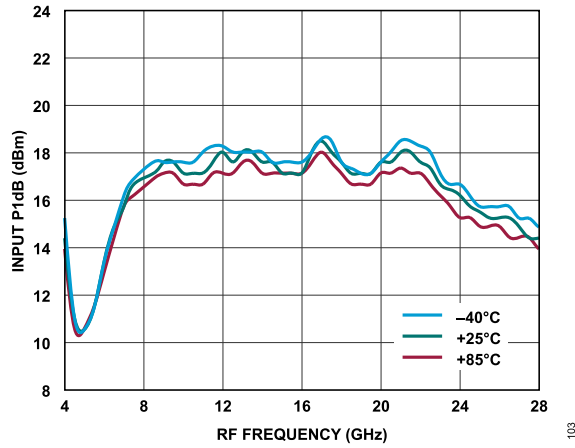

Figure 87. Input P1dB vs. RF Frequency at Various Temperatures, LO = 19 dBm

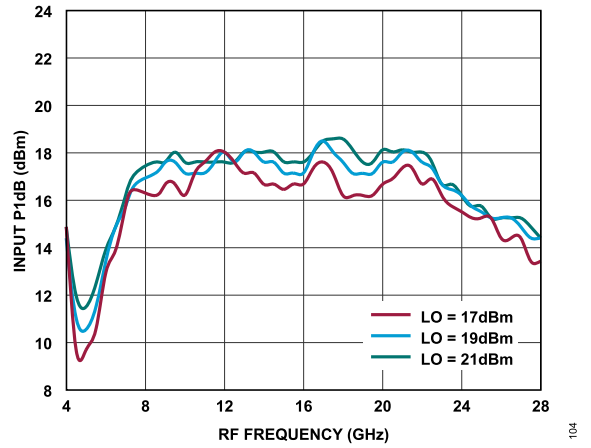

Figure 88. Input P1dB vs. RF Frequency at Various LO Power Levels,  $T_A = 25^\circ\text{C}$

TYPICAL PERFORMANCE CHARACTERISTICS

UPCONVERTER PERFORMANCE, IF = 10 GHz

Upper Sideband (Low-Side LO)

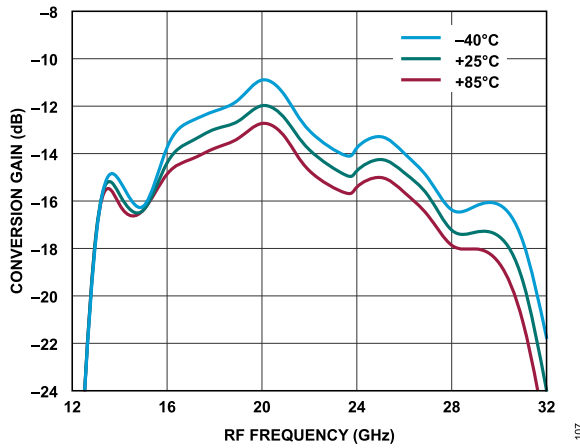

Figure 89. Conversion Gain vs. RF Frequency at Various Temperatures, LO = 19 dBm

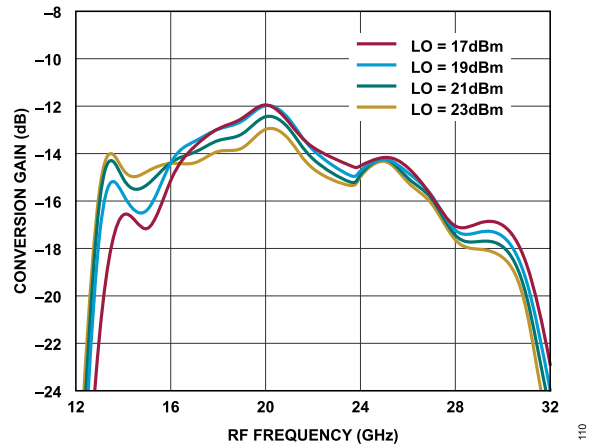

Figure 92. Conversion Gain vs. RF Frequency at Various LO Power Levels,  $T_A = 25^\circ\text{C}$

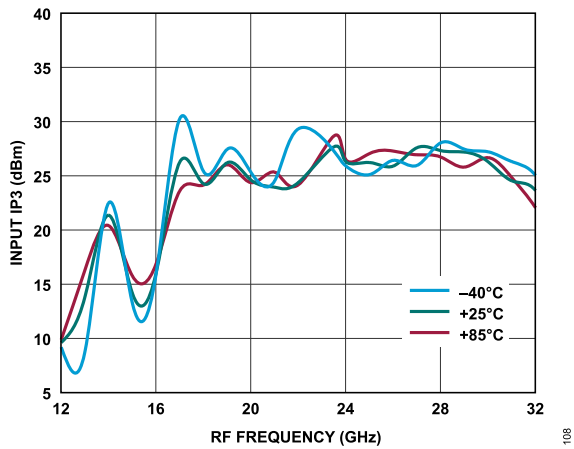

Figure 90. Input IP3 vs. RF Frequency at Various Temperatures, LO = 19 dBm

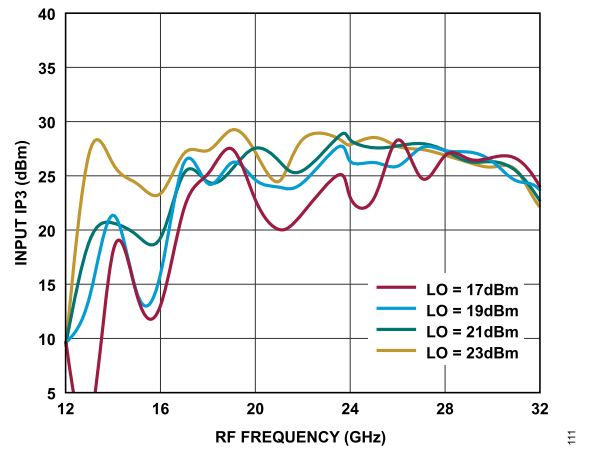

Figure 93. Input IP3 vs. RF Frequency at Various LO Power Levels,  $T_A = 25^\circ\text{C}$

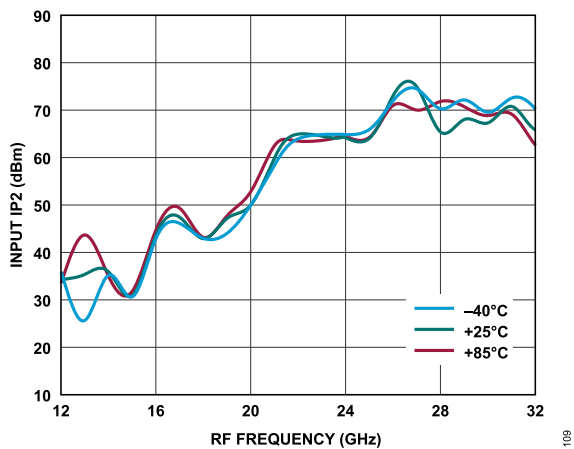

Figure 91. Input IP2 vs. RF Frequency at Various Temperatures, LO = 19 dBm

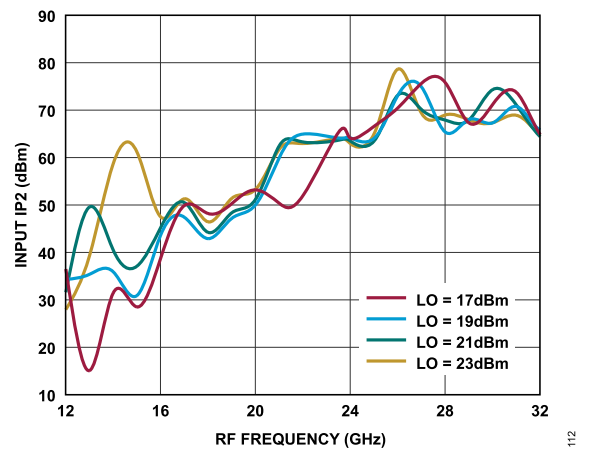

Figure 94. Input IP2 vs. RF Frequency at Various LO Power Levels,  $T_A = 25^\circ\text{C}$

TYPICAL PERFORMANCE CHARACTERISTICS

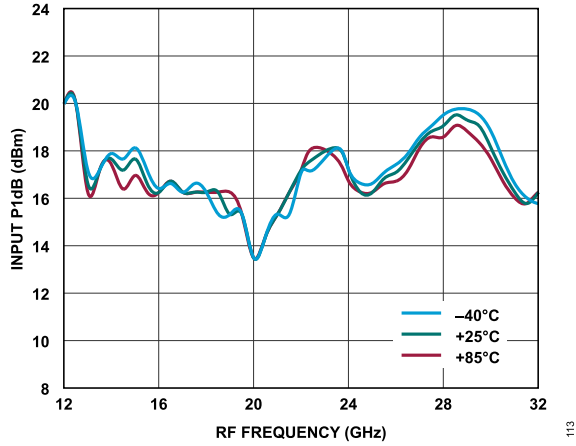

Figure 95. Input P1dB vs. RF Frequency at Various Temperatures, LO = 19 dBm

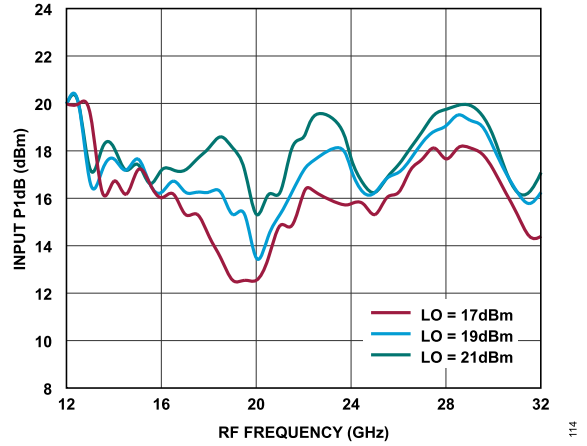

Figure 96. Input P1dB vs. RF Frequency at Various LO Power Levels, TA = 25°C

TYPICAL PERFORMANCE CHARACTERISTICS

Lower Sideband (High-Side LO)

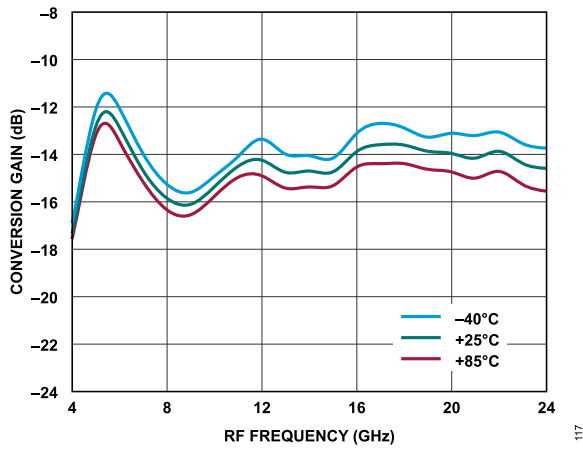

Figure 97. Conversion Gain vs. RF Frequency at Various Temperatures, LO = 19 dBm

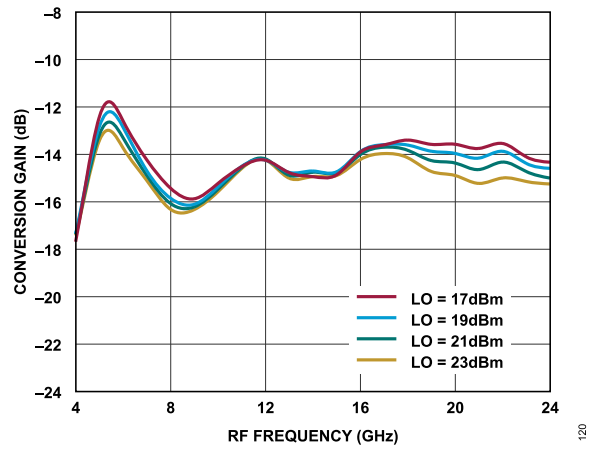

Figure 100. Conversion Gain vs. RF Frequency at Various LO Power Levels,  $T_A = 25^\circ\text{C}$

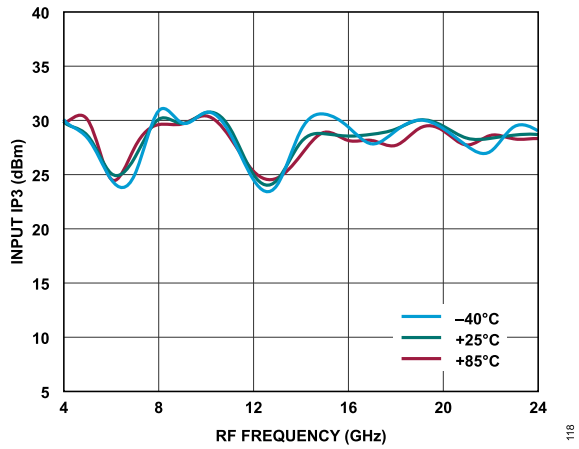

Figure 98. Input IP3 vs. RF Frequency at Various Temperatures, LO = 19 dBm

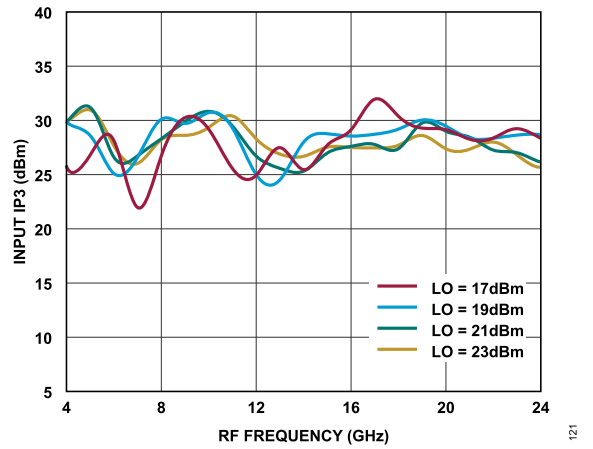

Figure 101. Input IP3 vs. RF Frequency at Various LO Power Levels,  $T_A = 25^\circ\text{C}$

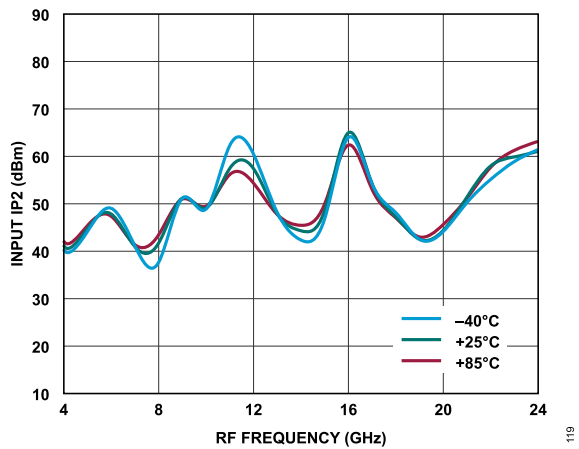

Figure 99. Input IP2 vs. RF Frequency at Various Temperatures, LO = 19 dBm

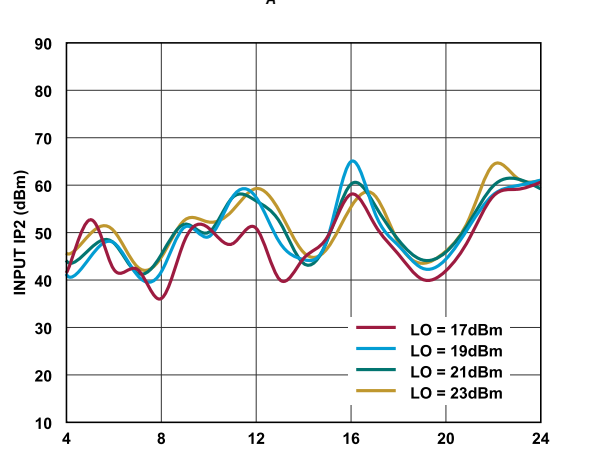

Figure 102. Input IP2 vs. RF Frequency at Various LO Power Levels,  $T_A = 25^\circ\text{C}$

TYPICAL PERFORMANCE CHARACTERISTICS

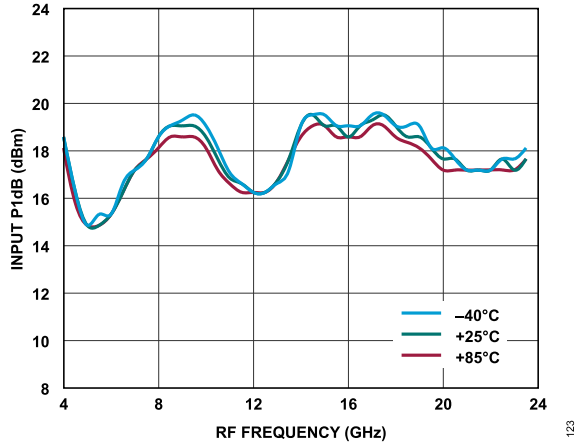

Figure 103. Input P1dB vs. RF Frequency at Various Temperatures, LO = 19 dBm

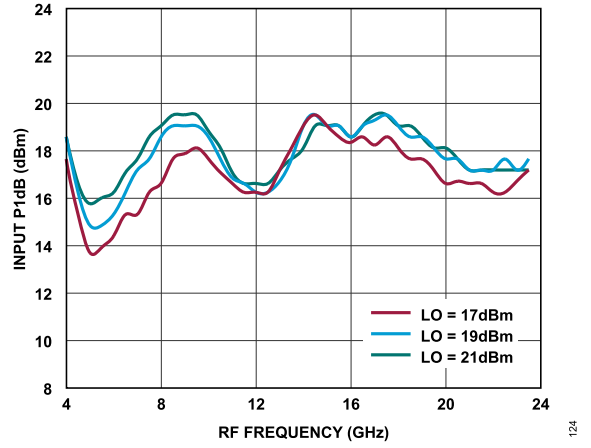

Figure 104. Input P1dB vs. RF Frequency at Various LO Power Levels, TA = 25°C

TYPICAL PERFORMANCE CHARACTERISTICS

ISOLATION AND RETURN LOSS

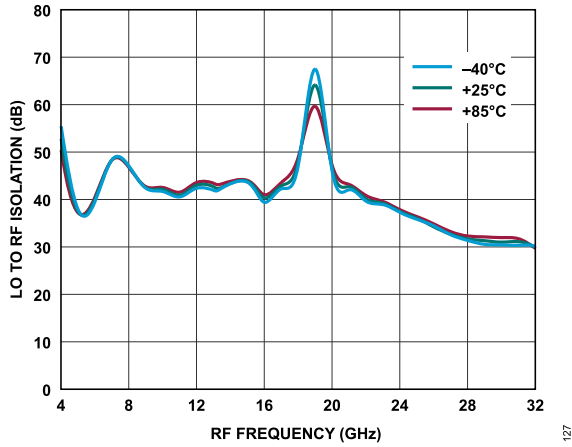

Figure 105. LO to RF Isolation vs. RF Frequency at Various Temperatures, LO = 19 dBm

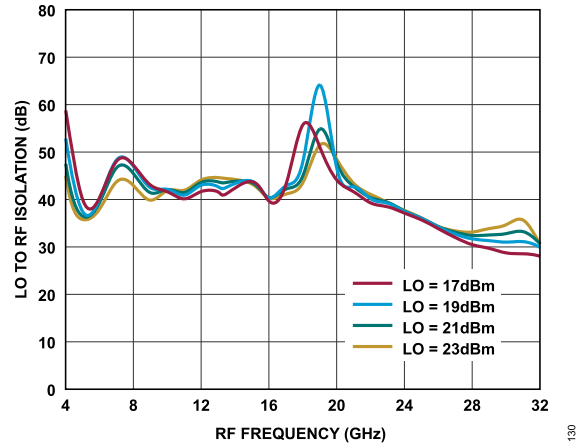

Figure 108. LO to RF Isolation vs. RF Frequency at Various LO Power Levels, TA = 25°C

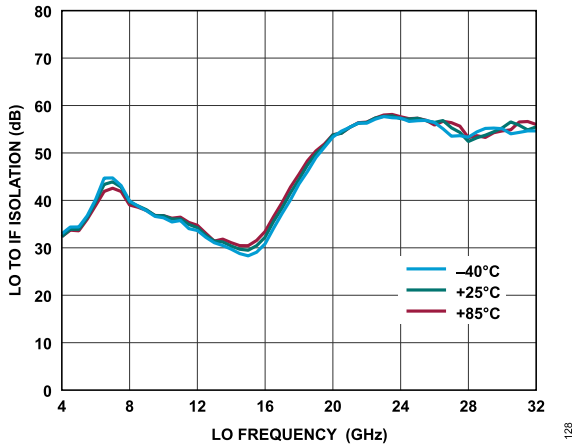

Figure 106. LO to IF Isolation vs. LO Frequency at Various Temperatures, LO = 19 dBm

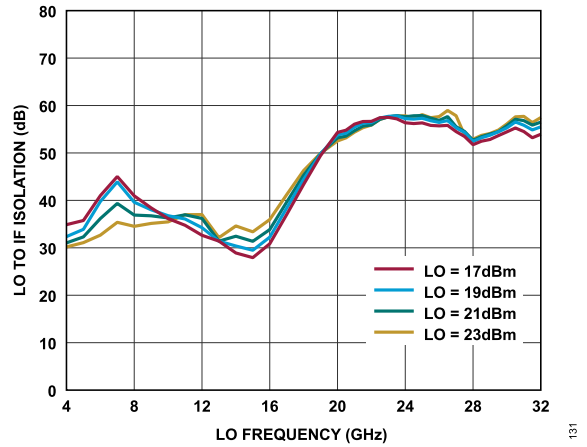

Figure 109. LO to IF Isolation vs. LO Frequency at Various LO Power Levels, TA = 25°C

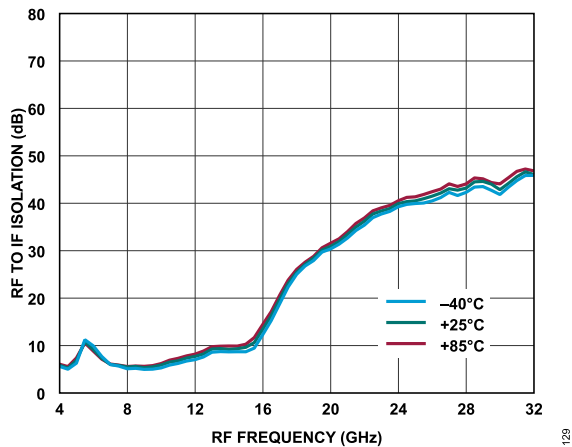

Figure 107. RF to IF Isolation vs. RF Frequency at Various Temperatures, LO = 19 dBm

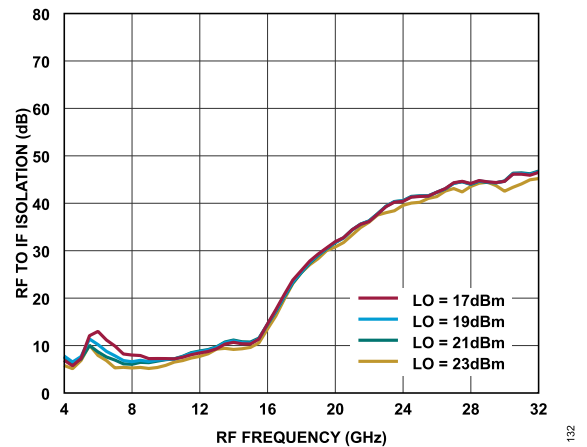

Figure 110. RF to IF Isolation vs. RF Frequency at Various LO Power Levels, TA = 25°C

TYPICAL PERFORMANCE CHARACTERISTICS

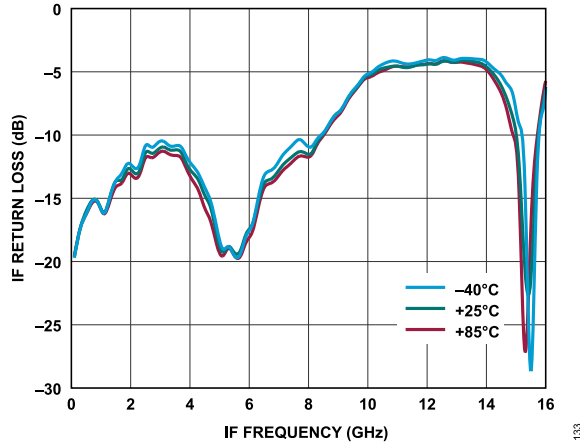

Figure 111. IF Return Loss vs. IF Frequency at Various Temperatures, LO = 20 GHz

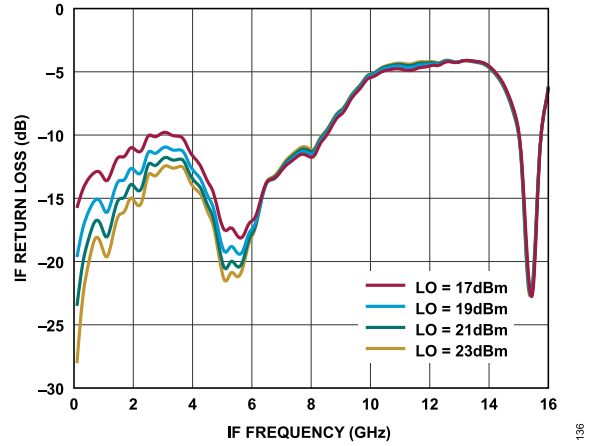

Figure 114. IF Return Loss vs. IF Frequency at Various LO Power Levels, TA = 25°C, LO = 20 GHz

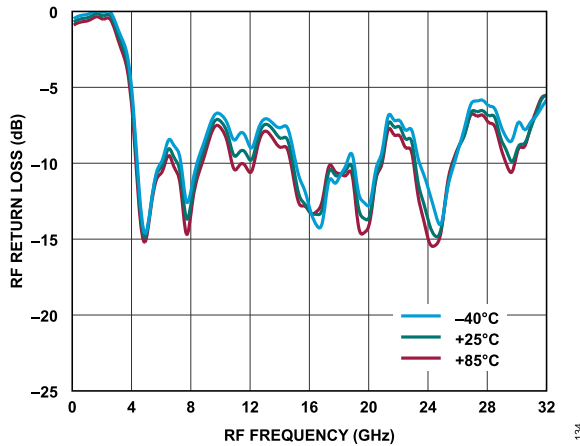

Figure 112. RF Return Loss vs. RF Frequency at Various Temperatures, LO = 20 GHz

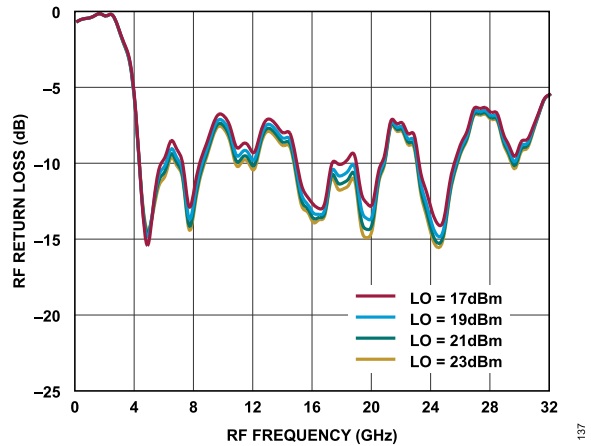

Figure 115. RF Return Loss vs. RF Frequency at Various LO Power Levels, TA = 25°C, LO = 20 GHz

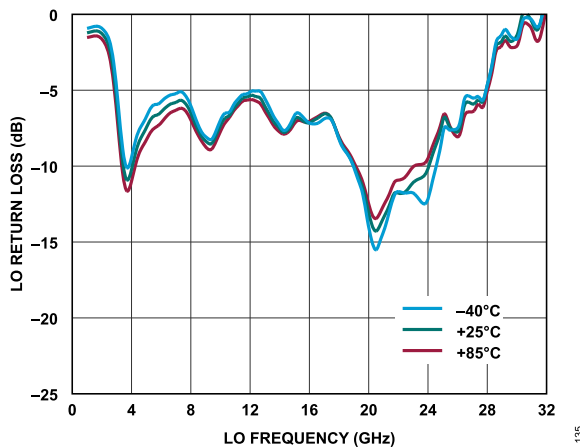

Figure 113. LO Return Loss vs. LO Frequency at Various Temperatures

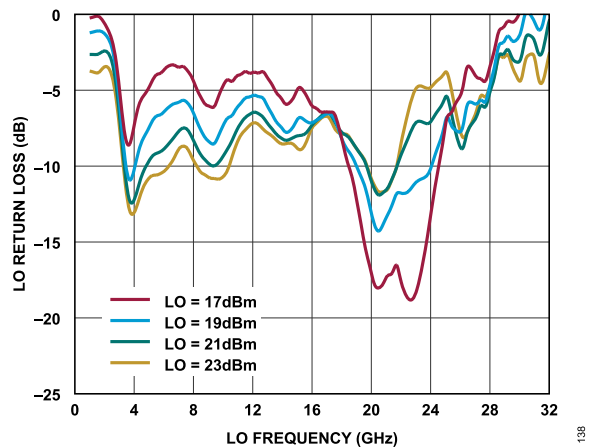

Figure 116. LO Return Loss vs. LO Frequency at Various LO Power Levels, TA = 25°C

TYPICAL PERFORMANCE CHARACTERISTICS

IF BANDWIDTH DOWNCONVERTER

Upper Sideband, LO Frequency = 8 GHz

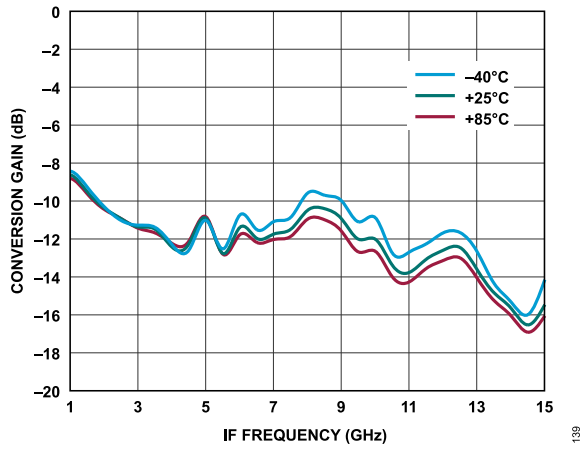

Figure 117. Conversion Gain vs. IF Frequency at Various Temperatures, LO = 19 dBm

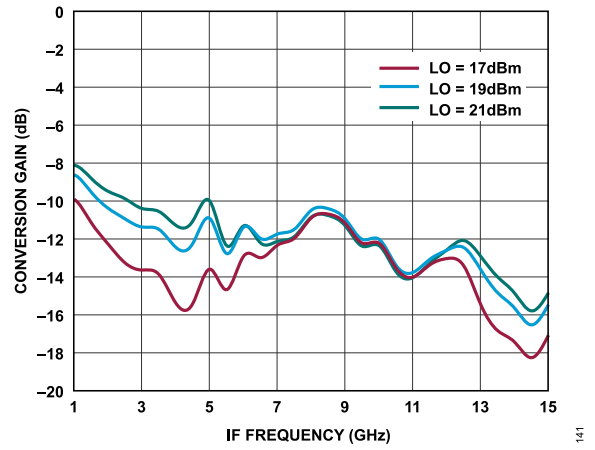

Figure 119. Conversion Gain vs. IF Frequency at Various LO Power Levels,  $T_A = 25^\circ\text{C}$

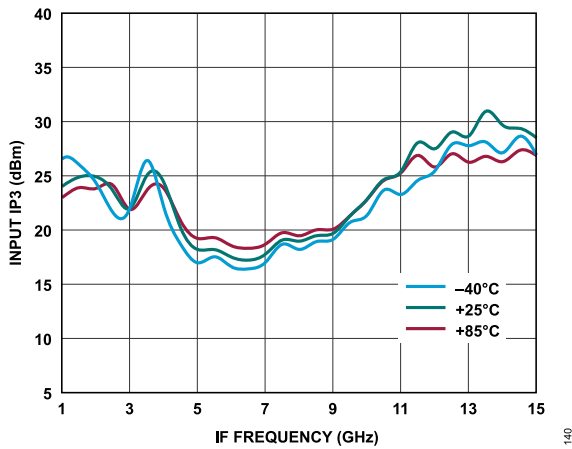

Figure 118. Input IP3 vs. IF Frequency at Various Temperatures, LO = 19 dBm

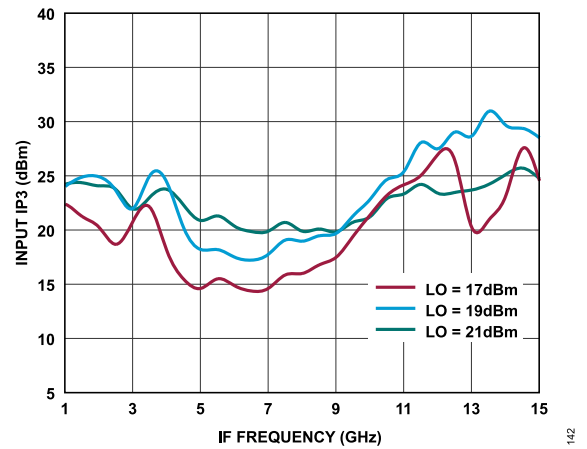

Figure 120. Input IP3 vs. IF Frequency at Various LO Power Levels,  $T_A = 25^\circ\text{C}$



TYPICAL PERFORMANCE CHARACTERISTICS

Lower Sideband, LO Frequency = 30 GHz

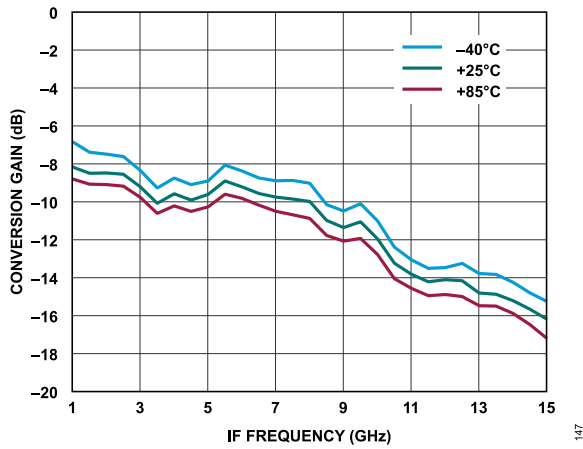

Figure 121. Conversion Gain vs. IF Frequency at Various Temperatures, LO = 19 dBm

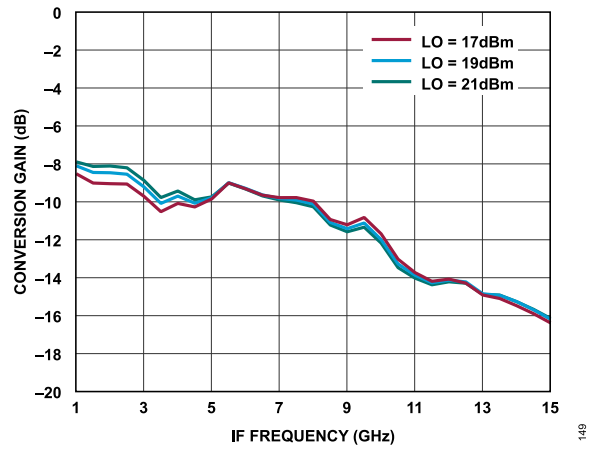

Figure 123. Conversion Gain vs. IF Frequency at Various LO Power Levels,  $T_A = 25^\circ\text{C}$

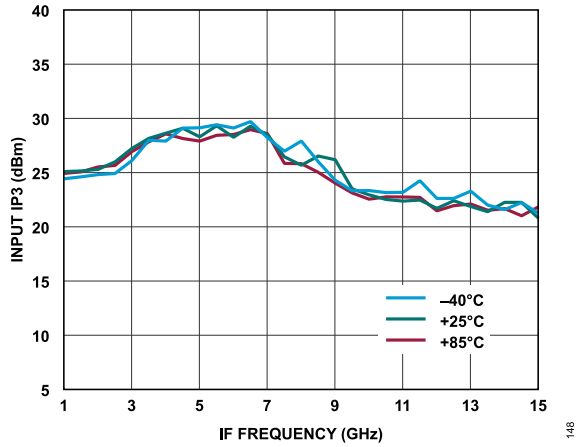

Figure 122. Input IP3 vs. IF Frequency at Various Temperatures, LO = 19 dBm

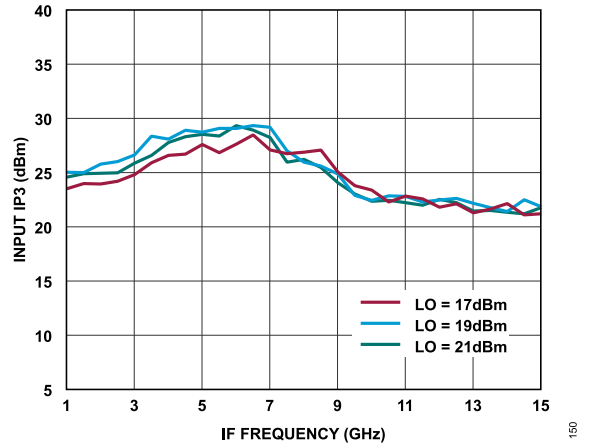

Figure 124. Input IP3 vs. IF Frequency at Various LO Power Levels,  $T_A = 25^\circ\text{C}$

TYPICAL PERFORMANCE CHARACTERISTICS

IF BANDWIDTH UPCONVERTER

Upper Sideband, LO Frequency = 8 GHz

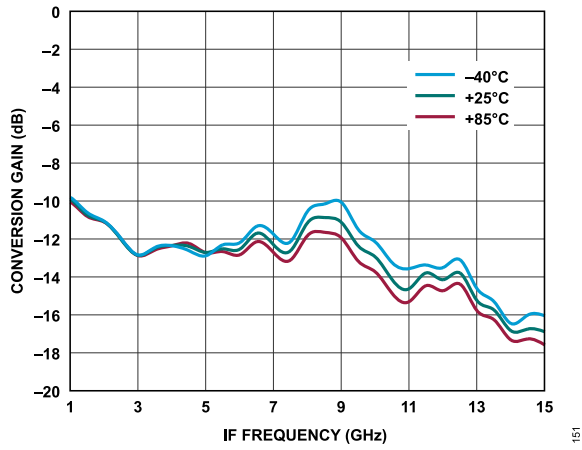

Figure 125. Conversion Gain vs. IF Frequency at Various Temperatures, LO = 19 dBm

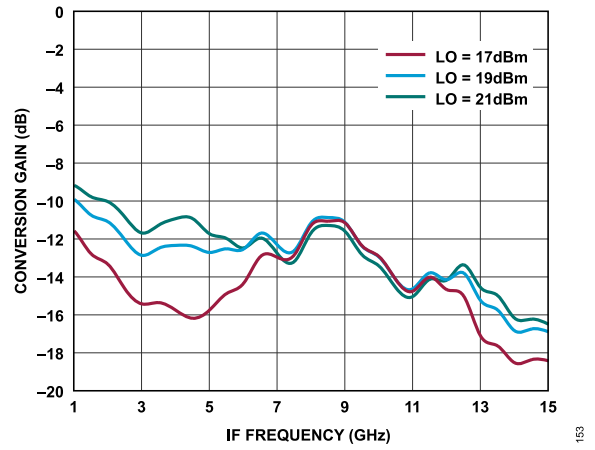

Figure 127. Conversion Gain vs. IF Frequency at Various LO Power Levels,  $T_A = 25^\circ\text{C}$

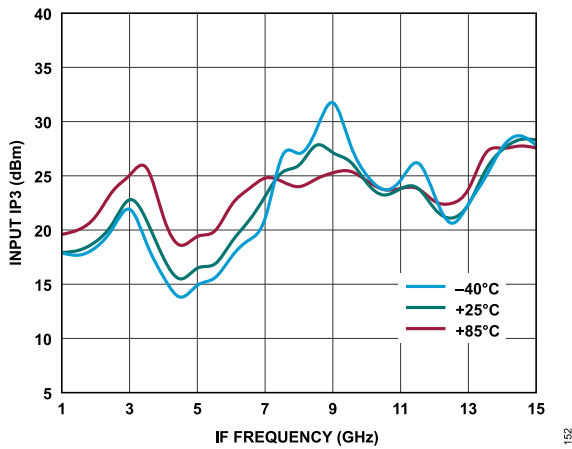

Figure 126. Input IP3 vs. IF Frequency at Various Temperatures, LO = 19 dBm

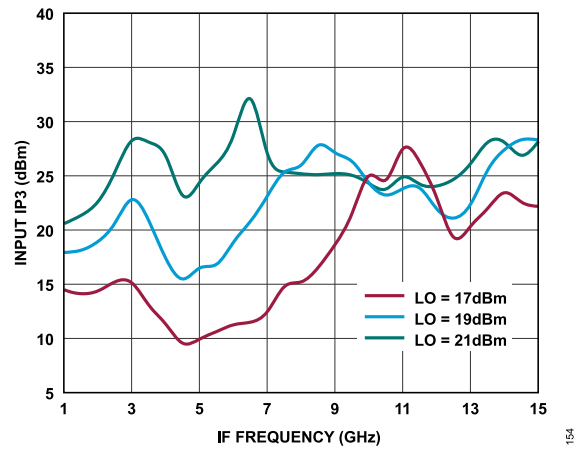

Figure 128. Input IP3 vs. IF Frequency at Various LO Power Levels,  $T_A = 25^\circ\text{C}$

TYPICAL PERFORMANCE CHARACTERISTICS

Lower Sideband, LO Frequency = 30 GHz

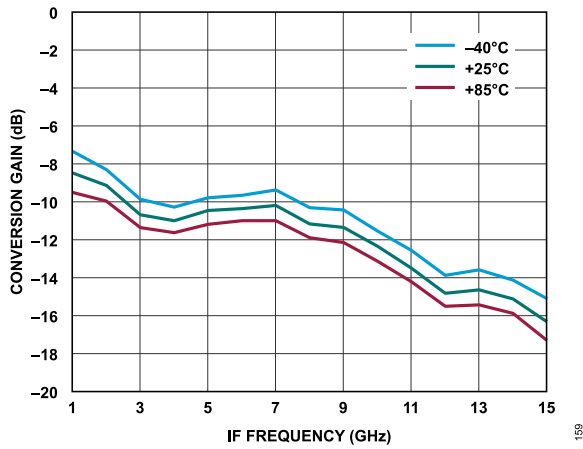

Figure 129. Conversion Gain vs. IF Frequency at Various Temperatures, LO = 19 dBm

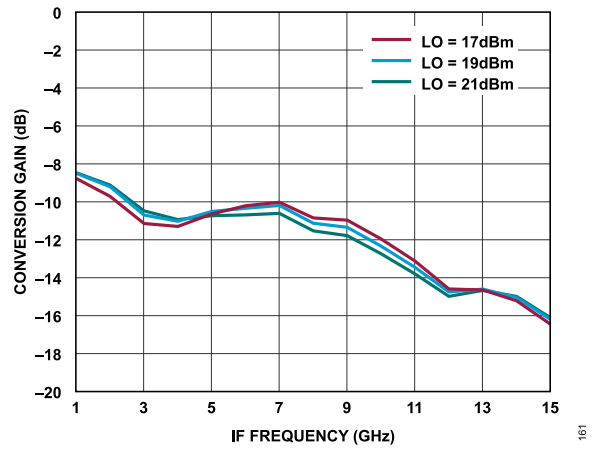

Figure 131. Conversion Gain vs. IF Frequency at Various LO Power Levels, TA = 25°C

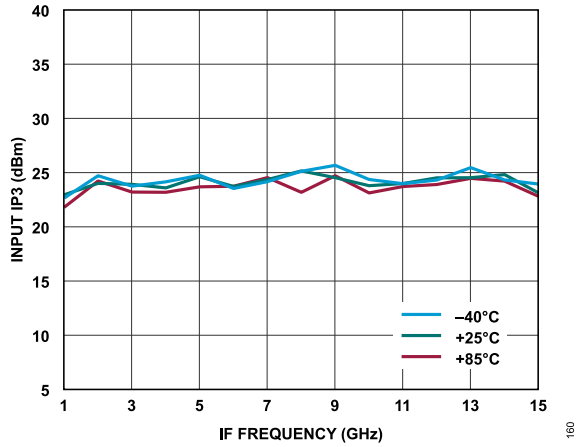

Figure 130. Input IP3 vs. IF Frequency at Various Temperatures, LO = 19 dBm

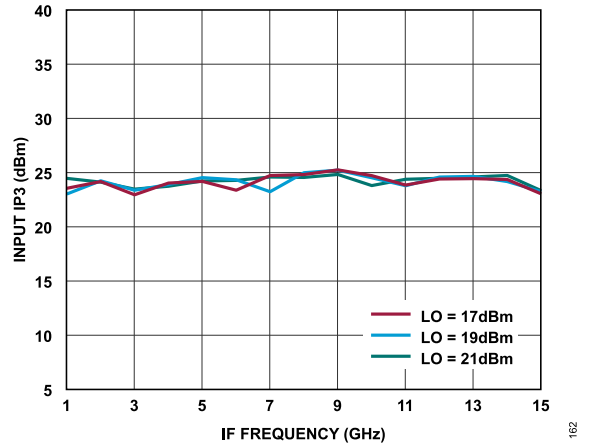

Figure 132. Input IP3 vs. IF Frequency at Various LO Power Levels, TA = 25°C

## TYPICAL PERFORMANCE CHARACTERISTICS

**M × N SPURIOUS OUTPUTS**

Mixer spurious products are measured in dBc from the IF output power level. N/A means not applicable.

**Downconverter, Upper Sideband**

Spur values are  $(M \times RF) - (N \times LO)$ .

IF output (IF<sub>OUT</sub>) = 1 GHz, RF input (RF<sub>IN</sub>) = 9 GHz at -10 dBm, and LO = 8 GHz at +19 dBm.

		N × LO				
		0	1	2	3	4
M × RF	0	N/A	3	28	38	48
	1	N/A	0	18	21	56
	2	62	69	61	60	62
	3	59	63	69	71	64
	4	45	61	62	68	73

IF<sub>OUT</sub> = 1 GHz, RF<sub>IN</sub> = 25 GHz at -10 dBm, and LO = 24 GHz at +19 dBm.

		N × LO				
		0	1	2	3	4
M × RF	0	N/A	21	47	N/A	N/A
	1	32	0	53	65	N/A
	2	N/A	96	66	95	80
	3	N/A	N/A	91	98	96
	4	N/A	N/A	N/A	94	108

**Downconverter, Lower Sideband**

Spur values are  $(M \times RF) - (N \times LO)$ .

IF<sub>OUT</sub> = 1 GHz, RF<sub>IN</sub> = 9 GHz at -10 dBm, and LO = 10 GHz at +19 dBm.

		N × LO				
		0	1	2	3	4
M × RF	0	N/A	N/A	32	41	43
	1	N/A	0	19	54	49
	2	63	69	70	62	62
	3	57	63	69	73	66
	4	45	58	62	74	73

IF<sub>OUT</sub> = 1 GHz, RF<sub>IN</sub> = 19 GHz at -10 dBm, LO = 20 GHz at +19 dBm.

		N × LO				
		0	1	2	3	4
M × RF	0	N/A	19	36	N/A	N/A
	1	22	0	50	59	N/A
	2	72	80	74	95	81
	3	N/A	76	101	84	97
	4	N/A	N/A	81	101	107

## TYPICAL PERFORMANCE CHARACTERISTICS

## Upconverter, Upper Sideband

Spur values are  $(M \times IF) + (N \times LO)$ .

$IF_{IN} = 1$  GHz at  $-10$  dBm,  $LO = 8$  GHz at  $+19$  dBm, and  $RF_{OUT} = 9$  GHz.

		N × LO				
		0	1	2	3	4
M × IF	0	N/A	5	9	15	32
	1	21	0	18	11	29
	2	52	42	57	50	54
	3	67	73	68	61	62
	4	73	74	69	65	61

$IF_{IN} = 1$  GHz at  $-10$  dBm,  $LO = 24$  GHz at  $+19$  dBm, and  $RF_{OUT} = 25$  GHz.

		N × LO				
		0	1	2	3	4
M × IF	0	N/A	N/A	28	N/A	N/A
	1	22	0	34	98	N/A
	2	N/A	42	76	97	99
	3	N/A	N/A	87	99	104
	4	N/A	N/A	N/A	97	95

## Upconverter, Lower Sideband

Spur values are  $(M \times IF) - (N \times LO)$ .

$IF_{IN} = 1$  GHz at  $-10$  dBm,  $LO = 10$  GHz at  $+19$  dBm, and  $RF_{OUT} = 9$  GHz.

		N × LO				
		0	1	2	3	4
M × IF	0	N/A	2	2	6	15
	1	20	0	14	18	14
	2	50	43	53	62	39
	3	67	64	64	57	41
	4	72	74	64	59	46

$IF_{IN} = 1$  GHz at  $-10$  dBm,  $LO = 20$  GHz at  $+19$  dBm, and  $RF_{OUT} = 19$  GHz.

		N × LO				
		0	1	2	3	4
M × IF	0	N/A	7	0	N/A	N/A
	1	23	0	18	96	N/A
	2	54	43	61	102	98
	3	N/A	76	77	100	103
	4	N/A	N/A	84	101	100

## THEORY OF OPERATION

The ADMV1530 is a general-purpose, double balanced mixer that can be used as an upconverter or a downconverter from 5 GHz to 30 GHz.

When used as a downconverter, the ADMV1530 downconverts radio frequencies between 5 GHz and 30 GHz to intermediate frequencies between DC and 10 GHz.

When used as an upconverter, the mixer upconverts intermediate frequencies between DC and 10 GHz to radio frequencies between 5 GHz and 30 GHz.

APPLICATIONS INFORMATION

TYPICAL APPLICATION CIRCUIT

Figure 133 shows the typical application circuit for the ADMV1530. The ADMV1530 is a passive device that does not require any external components. The LO and RF pins are internally AC-coupled. The IF pin is internally DC-coupled. For applications not requiring operation to DC, DC block this port externally using a series capacitor of a value chosen to pass the necessary IF frequency range. When IF operation to DC is required, do not exceed the IF source and sink current ratings specified in the Absolute Maximum Ratings section.

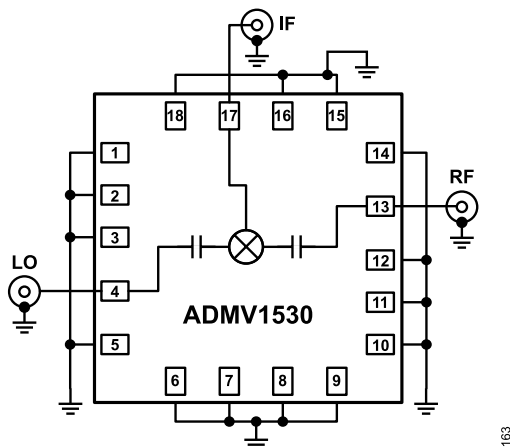

Figure 133. Typical Application Circuit

EVALUATION PCB INFORMATION

The circuit board used in the application must use RF circuit design techniques. Signal lines must have 50 Ω impedance, and the package grounds leads and exposed pad must be connected directly to the ground plane similarly to that shown in Figure 134. Use a sufficient number of via holes to connect the top and bottom ground planes. The evaluation circuit board shown in Figure 134 is available from Analog Devices, Inc., upon request.

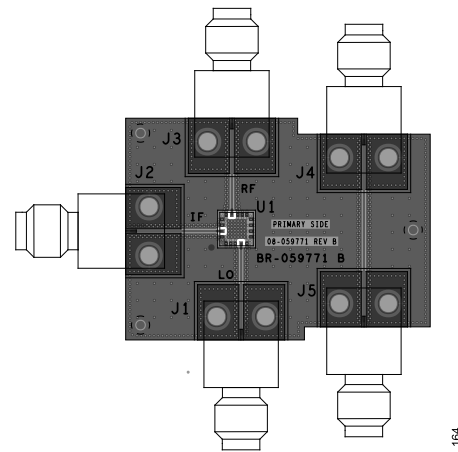

Figure 134. Evaluation PCB Top Layer

Table 7. Bill of Materials for the ADMV1530-EVALZ Evaluation PCB

Quantity	Reference Designator	Description	Manufacturer	Part Number
1		PCB, evaluation board		08-059771
5	J1 to J5	Connectors, 2.92 mm, 40 GHz	Southwest Microwave	1092-01A-9
1	U1	Device under test (DUT)	Analog Devices	<a href="#">ADMV1530ACCZ</a>

OUTLINE DIMENSIONS

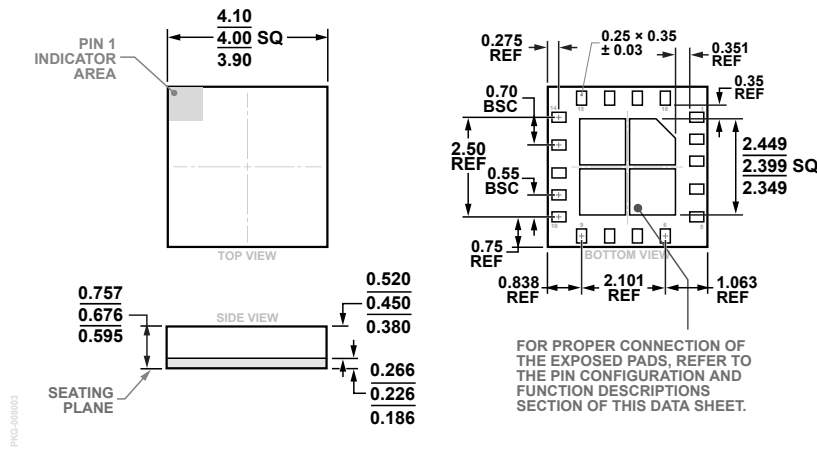

Figure 135. 18-Terminal Land Grid Array [LGA] (CC-18-3)  
Dimensions shown in millimeters

ORDERING GUIDE

Model <sup>1</sup>	Temperature Range	Package Description	Package Option	Package Quantity
ADMV1530ACCZ	-40°C to +85°C	18-Terminal Land Grid Array [LGA]	CC-18-3	
ADMV1530ACCZ-RL7	-40°C to +85°C	18-Terminal Land Grid Array [LGA]	CC-18-3	Reel, 1000

<sup>1</sup> Z = RoHS-Compliant Part.

EVALUATION BOARDS

Table 8. Evaluation Boards

Model <sup>1</sup>	Description
ADMV1530-EVALZ	Evaluation Board

<sup>1</sup> Z = RoHS-Compliant Part.