

Products Catalog

## Fixed Resistors

- General purpose chip resistors type
- High precision type
- Current sensing type
- Small & High power type
- Anti-Sulfurated type
- High temperature type
- Array type / Resistor network

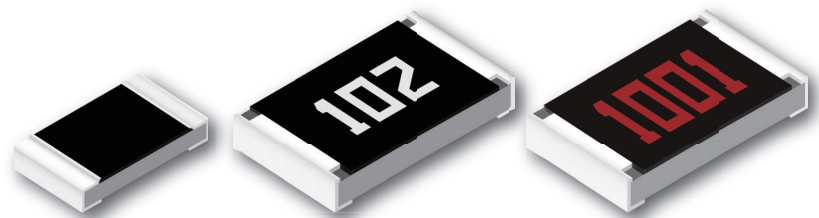

**IN Your  
Future**



# Fixed Resistors (Surface Mount Resistors) INDEX

Classification	Product item	Part No.	Page
<a href="#">Safety and Legal Matters to Be Observed / Matters to Be Observed When Using This Product</a>			1
General purpose chip resistors	<a href="#">Thick film chip resistors</a>	ERJ XG, 1G, 2G, 3G, 6G, ERJ 8G*, 14*, 12*, 12Z*, 1T*	5
	<a href="#">Precision thick film chip resistors</a>	ERJ XG, 1G, 1R, 2R, 3R, 6R, 3E, 6E, 8E*, ERJ 14*, 12*, 1T*	8
High precision	<a href="#">Thin film chip resistors, High voltage type</a>	ERA 8P	12
	<a href="#">Thin film chip resistors, High stability and reliability type</a>	ERA 2V, 3V, 3K, 6V, 6K, 8V, 8K	14
	<a href="#">Metal film (Thin film) Chip resistors, High reliability type</a>	ERA 1A, 2A, 3A, 6A, 8A	17
	<a href="#">High precision thick film chip resistors</a>	ERJ PB3, PB6	20
Current sensing	<a href="#">Thick film chip resistors / Low resistance type</a>	ERJ 2LW, 3LW, 6LW, ERJ 2BW, 3BW, 6BW, 8BW, 6CW, 8CW ERJ 2BS/Q, 3BS/Q, 6DS/Q, 6BS/Q, 8BS/Q, 14BS/Q ERJ 3RS/Q, 6RS/Q, 8RS/Q, 14RS/Q, 12RS/Q, 12ZS/Q, 1TRS/Q ERJ L03, L06, L08, L14, L12, L1D	22
	<a href="#">Current sensing resistors, Metal plate type</a>	ERJ MS4S*, MS4H*, MB1S*	28
	<a href="#">High power chip resistors / Wide terminal type</a>	ERJ A1, B1, B2, B3	32
	<a href="#">Low TCR high power chip resistors / Wide terminal type</a>	ERJ D1, D2	37
Small & High power	<a href="#">Anti-Surge thick film chip resistors</a>	ERJ PA2, P03, PA3, P06, P08, PM8, P14	40
	<a href="#">Anti-Surge thick film chip resistors (Double-sided resistive elements structure)</a>	ERJ P6W*	45
	<a href="#">Anti-Pulse thick film chip resistors</a>	ERJ T06, T08, T14	47
Anti-Sulfurated	<a href="#">Anti-Sulfurated thick film chip resistors</a>	ERJ S02, S03, S06, S08, S14, S12, S1D, S1T, ERJ U0X, U01, U02, U03, U06, U08, U14, U12, ERJ U1D, ERJ U1T, ERJ U6S, U6Q	50
	<a href="#">Anti-Sulfurated thick film chip resistors / Precision type</a>	ERJ U2R, U3R, U6R	54
	<a href="#">Anti-Sulfurated thick film chip resistors / Anti-Surge type</a>	ERJ UP3, UP6, UP8	56
	<a href="#">Anti-Sulfurated thick film chip resistors / Wide terminal type</a>	ERJ C1	59
High temperature	<a href="#">High temperature thick film chip resistors (Automotive Grade)</a>	ERJ H2G, H2C, H2R, H3G, H3E, H3Q, H6G, HP6	62
Resistor network/Array	<a href="#">Chip resistor array</a>	EXB 14V, 18V, 24V, 28V, N8V, 2HV, 34V, V4V, 38V, V8V, S8V	65
	<a href="#">Anti-Sulfurated chip resistor array</a>	EXB U14, U18, U24, U28, U2H, U34, U38	69
	<a href="#">Chip resistor networks</a>	EXB D, E, A, Q	72
	<a href="#">Chip attenuator</a>	EXB 14AT, 24AT	76
Common specifications	<a href="#">Packaging methods (Taping)</a>		78
	<a href="#">Recommended land pattern</a>		83
	<a href="#">Recommended soldering conditions</a>		86
	<a href="#">Standard for resistance value and resistance tolerance</a>		87

\*Not Recommended for New Design

## Safety and Legal Matters to Be Observed

### Product specifications and applications

- Please be advised that this product and product specifications are subject to change without notice for improvement purposes. Therefore, please request and confirm the latest delivery specifications that explain the specifications in detail before the final design, or purchase or use of the product, regardless of the application. In addition, do not use this product in any way that deviates from the contents of the company's delivery specifications.
- Unless otherwise specified in this catalog or the product specifications, this product is intended for use in general electronic equipment (AV products, home appliances, commercial equipment, office equipment, information and communication equipment, etc.).  
When this product is used for the following special cases, the specification document suited to each application shall be signed/sealed (with Panasonic Industry and the user) in advance..These include applications requiring special quality and reliability, wherein their failures or malfunctions may directly threaten human life or cause harm to the human body (e.g.: space/aircraft equipment, transportation/traffic equipment, combustion equipment, medical equipment, disaster prevention/crime prevention equipment, safety equipment, etc.).

### Safety design and product evaluation

- Please ensure safety through protection circuits, redundant circuits, etc., in the customer's system design so that a defect in our company's product will not endanger human life or cause other serious damage.
- This catalog shows the quality and performance of individual parts. The durability of parts varies depending on the usage environment and conditions. Therefore, please ensure to evaluate and confirm the state of each part after it has been mounted in your product in the actual operating environment before use.  
If you have any doubts about the safety of this product, then please notify us immediately, and be sure to conduct a technical review including the above protection circuits and redundant circuits at your company.

### Laws / Regulations / Intellectual property

- The transportation of dangerous goods as designated by UN numbers, UN classifications, etc., does not apply to this product. In addition, when exporting products, product specifications, and technical information described in this catalog, please comply with the laws and regulations of the countries to which the products are exported, especially those concerning security export control.
- Each model of this product complies with the RoHS Directive (Restriction of the use of hazardous substances in electrical and electronic equipment) (2011/65/EU and (EU) 2015/863). The date of compliance with the RoHS Directive and REACH Regulation varies depending on the product model.  
Further, if you are using product models in stock and are not sure whether or not they comply with the RoHS Directive or REACH Regulation, please contact us by selecting "Sales Inquiry" from the inquiry form.
- During the manufacturing process of this product and any of its components and materials to be used, Panasonic Industry does not intentionally use ozone-depleting substances stipulated in the Montreal Protocol and specific bromine-based flame retardants such as PBBs (Poly-Brominated Biphenyls) / PBDEs (Poly-Brominated Diphenyl Ethers). In addition, the materials used in this product are all listed as existing chemical substances based on the Act on the Regulation of Manufacture and Evaluation of Chemical Substances.
- With regard to the disposal of this product, please confirm the disposal method in each country and region where it is incorporated into your company's product and used.
- The technical information contained in this catalog is intended to show only typical operation and application circuit examples of this product. This catalog does not guarantee that such information does not infringe upon the intellectual property rights of Panasonic Industry or any third party, nor imply that the license of such rights has been granted.
- Design, materials, or process related to technical owned by Panasonic Industry are subject to change without notice.

**Panasonic Industry will assume no liability whatsoever if the use of our company's products deviates from the contents of this catalog or does not comply with the precautions. Please be advised of these restrictions.**

## Matters to Be Observed When Using This Product

### (Fixed resistor)

#### Use environments and cleaning conditions

- This product (fixed resistor) is not designed for use in specific environments. Using the resistor in the following specific environments or service conditions may affect the performance/reliability of the resistor. Avoid using it in such specific environments. If you intend to use the resistor in such environments, checking the performance, reliability, etc., of the product sufficiently is your own responsibility.
  - (1) Used in liquid, such as water, oil, chemicals, and organic solvents.
  - (2) Used in a place exposed to direct sunlight, an outdoor place with no shielding, or a dusty place.
  - (3) Used in a place where the product is heavily exposed to sea breeze or a corrosive gas, such as Cl<sub>2</sub>, H<sub>2</sub>S, NH<sub>3</sub>, SO<sub>2</sub>, or NO<sub>x</sub>.
  - (4) Used in an environment where static electricity and electromagnetic waves are strong.
  - (5) Located close to a heating component or a flammable material, such as a vinyl cable placed near the product.
  - (6) Sealed or coated with a resin.
  - (7) Solder flux of the resistor soldered with no-clean type solder, etc., is cleansed with a solvent, water, or a water-soluble cleaner, etc. (Water-soluble flux residues have a particularly large influence on a resistor.)
  - (8) Used in a place where dew concentrates on the product.
  - (9) Used in a contaminated state.  
(Example: Touching the resistor mounted on a printed board leaving sebum on the resistor (improper handling))
- Sealing the resistor with a resin in a resin potting process, damp-proofing process, etc., applies excessive stress to the resistor, which may cause the internal electrodes a connection problem. In such cases, the proper operation of the resistor is not guaranteed. If you intend to use the resistor in such environments, checking the performance, reliability, etc., of the product sufficiently is your own responsibility.
- Do not leave the resistor immersed in a solvent for a long time. When using the resistor immersed in a solvent, confirm the operation of the product mounted on the board.
- When a cleaning solution or cleaning condition for cleaning the printed board or a drying condition for drying the printed board after soldering the resistor is improper, it may have a negative effect on the performance/reliability of the resistor. Confirming these conditions sufficiently is your own responsibility. Also examine the effects of soiled cleaning agent, cleaning residues, and post-cleaning contaminations, and control for these effects properly.

#### Response to anomalies and handling conditions

- When the resistor is heating abnormally or emitting a smell, stop using the resistor immediately, for example, turn off the main power supply of the device.  
Also, keep your face and hands away from the product as it may become hot and cause burns.
- The resistor is so thin that it may break easily when subjected to impact. Before putting the resistor in use, confirm that the resistor has not been broken by impact that applied thereto when mounted on the printed board. Applying impact to the resistor or pinching the resistor with a hard tool (pliers, tweezers, etc.) may chip the resistor or its protective film, which affects its performance. Be careful to avoid such cases.
- Do not reuse a resistor having been used on a printed board and removed therefrom. Do not touch the resistor with your bare hands.
- Be careful not to drop the resistor on the floor, etc. The resistor is likely to suffer mechanical or electrical damage when dropped on the floor. Avoid using said resistor.
- The resistor may have its resistance value changed due to electrostatic discharge (ESD). Take ESD prevention measures when handling the resistor. ESD prevention measures include an environment where static electricity is not likely to be generated (recommended RH: 40% to 60%), by wearing an earth band, conductive gloves, etc., grounding the device in which the resistor is incorporated, and placing a conductive mat, etc., on a work platform.
- It is guaranteed that a resistor not exposed to any stress will have its proper resistance value. Any stress or pressure applied to the resistor may cause its resistance value to change. Examine and evaluate the characteristics of the resistor sufficiently before using it.

## Reliability and product life

A product conforming to "AEC-Q200" refers to a product having passed some or all of the evaluation test items defined in AEC-Q200. To know the detailed specifications of individual products or specific evaluation test scores, please contact us. We issue a delivery specification sheet for each product ordered. Please confirm with the sheet when you place an order with us.

## Circuit design and circuit board design

- To prevent a case where a transient load (e.g., a pulse for a short period) too large for the product to handle is applied, make sure to evaluate and confirm the operation of the product incorporated in your product. Applying power or voltage (current) larger than the rated power or rated voltage (current) to the resistor may impair its performance and reliability. Make sure to use the resistor with power or voltage (current) equal to or lower than the rated power or rated voltage (current). The product warranty does not cover usage where an excessively large load, such as a pulse current, is applied to the product.
- The resistor may have a high temperature even when used with power equal to or lower than the rated power. Be careful in such cases. Another factor to be considered are effects on the board, peripheral components, etc., and the effects of peripheral components on the resistor. Make sure to confirm first that the temperature of the resistor incorporated in your product is equal to or lower than the specified temperature, and then use the resistor.
- When the resistors are connected in series or parallel, loads applied respectively to the resistors may not be equal to each other. Check whether the loads are equal in the actual circuit in which the resistors are incorporated.
- When a resistor is used in a high-frequency circuit, the resistor may fail to offer the required characteristics. Check whether the resistor offers the required characteristics in the actual circuit in which the resistors are incorporated.
- Be careful that unusual stress caused by an excessive bend of the printed board is not applied to the resistor. Design the circuit structure such that the resistor is not close to a perforated line for board splitting or on a line with sizable holes bored on the board.
- When a different component is mounted on the board where the resistor has been soldered, be careful that the board does not bend excessively. If necessary, provide the board with backup pins (support pins) to keep it straight.
- Avoid manual board splitting. Use a jig, etc., to break the board so that it does not bend excessively when split apart.

## Mounting conditions

- When the product is used under mounting conditions departing from mounting conditions specified in our specification sheet, the product may be exposed to unexpected stress to fail. Be careful to avoid such a case. When mounting the resistor on a printed board, set the resistor's front and back surfaces in the direction indicated by the tape. Make sure to evaluate and confirm the operation of the resistor incorporated in your product and determine whether the resistor is usable as a component of the product.
- Set soldering conditions for the resistor within the recommended soldering conditions specified by our company. Any time, soldering condition departing from the specified soldering condition, such as a high peak temperature or a long heating may impair the performance/reliability of the resistor. Note that the specified soldering conditions indicate conditions under which degradation of the resistor characteristics does not occur but do not indicate conditions under which stable soldering can be performed. Check and set individual conditions under which stable soldering can be performed.
- Heat the resistor in advance so that a difference between the soldering temperature and the temperature of the resistor surface is reduced to 100 °C or lower. When dipping the soldered resistor in a solvent, etc., to cool the resistor rapidly, ensure that the temperature difference between the resistor and the solvent is 100 °C or lower during the dipping.
- When soldering the resistor using a soldering iron, apply hot air, etc., to the resistor to heat it sufficiently in advance and then solder the resistor without bringing the soldering iron tip into contact with the product. If the temperature of the soldering iron tip is high, finish the soldering work quickly (within 3 seconds when the temperature of the soldering iron tip is 350 °C or lower). In the case of a fixed resistor with low resistance, the resistor may fail to offer the exactly intended resistance value because of the variation in the solder volume, etc. Make sure to confirm the resistance value of the resistor in the actual circuit configuration.

- Soldering the resistor with too much solder or too little solder results in the poor reliability of the solder connection of the resistor. Use the proper volume of solder in the soldering process. Sufficiently check for the volume of solder used.
- Soldering with high bond strength or special property solder may affect the quality of the resistor. Do not use such solder.
- Use rosin-based solder flux. When using highly active solder flux made mainly of halogen (chlorine, bromine, etc.), flux residues may affect the performance and reliability of the resistor. Check the effects of flux residues before using the solder flux. Do not use highly acidic flux, water-soluble flux, or flux containing fluoride ions. When solder flux sticks to the resistor after the soldering process, the activation energy of the flux may corrode the resistor and cause it to fail. Prevent solder flux from sticking to the resistor.

## Storage conditions

Keeping the product in the following environments or conditions may lead to degradation of its performance, solderability, etc. Do not keep the product in the following environments.

- (1) Stored in a place where the product is heavily exposed to sea breeze or a corrosive gas, such as Cl<sub>2</sub>, H<sub>2</sub>S, NH<sub>3</sub>, SO<sub>2</sub>, or NO<sub>x</sub>.
- (2) Stored in a place where the product is exposed to direct sunlight.
- (3) Stored in a place where a temperature condition of 5 °C to 35 °C and a relative humidity condition of 45% to 85% cannot be maintained.
- (4) Kept in storage for more than one year from the delivery date (when the product is kept in conditions excluding any of the environments (1) to (3)).

## Reference information

### Guidelines

Before using the resistor, refer to the technical report issued by JEITA, EIAJ RCR-2121B "Safety Application Guide for Fixed Resistor for Use in Electronic Equipment" revised in February 2015.

## Thick Film Chip Resistors

ERJ type

**ERJ XG, 1G, 2G, 3G, 6G series**

**ERJ 8G, 14, 12, 12Z, 1T series**

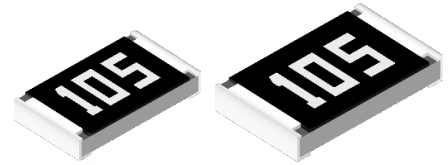

(Oct. 2021) Products marked as "NRFND" are not recommended for new design.  
 Target products : ERJ8G, 14, 12, 12Z, 1T series  
 Please refer to the recommended alternatives with "Design Support Tool" .

### Features

- Small size and lightweight
- High reliability : Metal glaze thick film resistive element and three layers of electrodes
- Compatible with placement machines : Taping packaging available
- Suitable for both reflow and flow soldering
- Reference standard : IEC 60115-8, JIS C 5201-8, JEITA RC-2134C
- AEC-Q200 compliant (except ERJXG, ERJ1GN)
- RoHS compliant

■ **As for packaging methods, land pattern, soldering conditions and safety precautions, please see data files.**

### Explanation of part numbers

Note : Please check the "Ratings" for the presence/absence of part numbers for combinations of the symbols below.

- ERJ XGN, 1GN, 1GJ, 2GE, 3GE, 6GE, 8GE, 14, 12, 12Z, 1T series, ±5 %

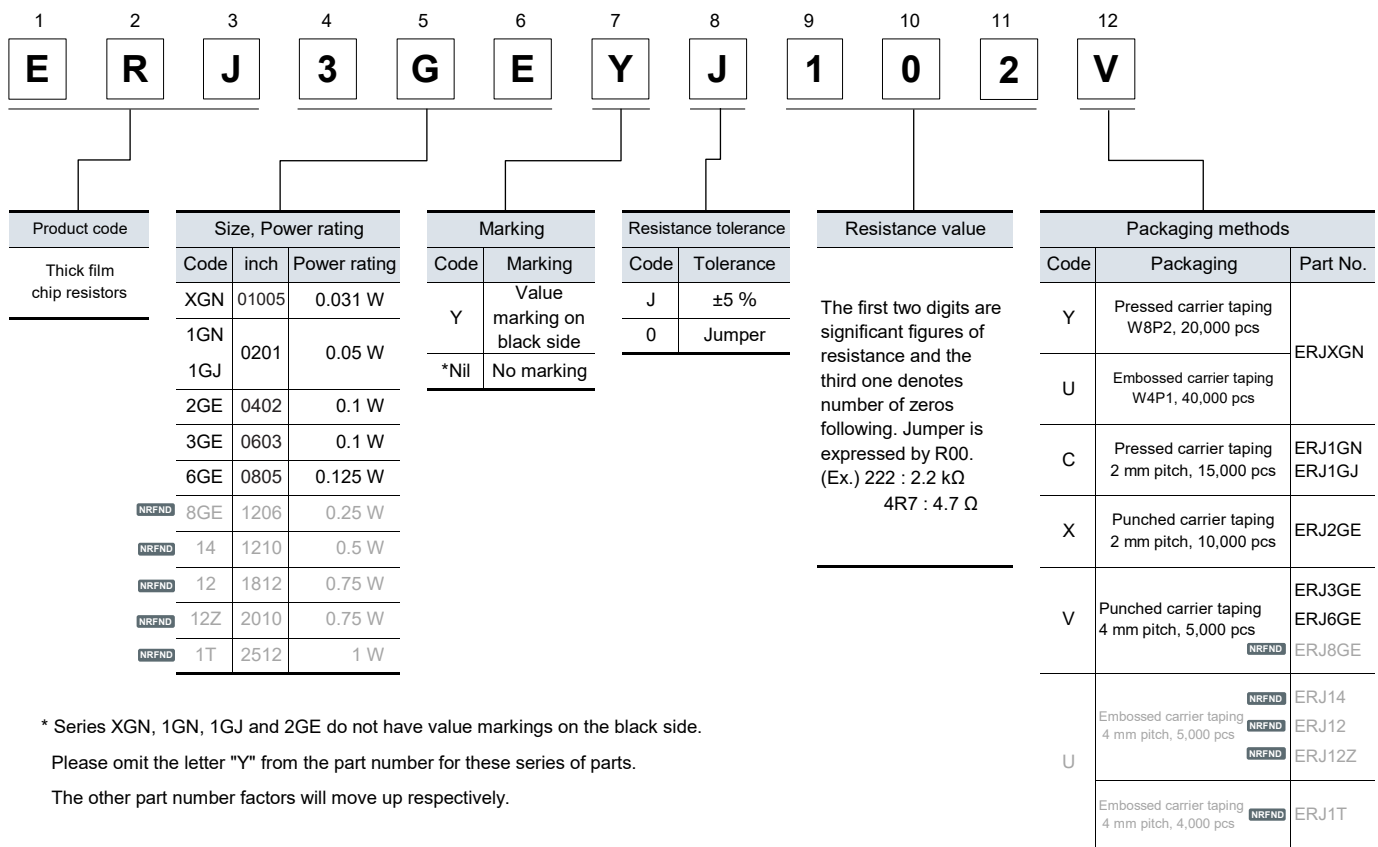

\* Series XGN, 1GN, 1GJ and 2GE do not have value markings on the black side.

Please omit the letter "Y" from the part number for these series of parts.

The other part number factors will move up respectively.

\* For the automotive application, please use ERJ1GJ as 0201 inch size from the new design.

Not recommended for new design

## Ratings

### [For Resistor]

Part No. (inch size)	Rated power <sup>*1</sup> (70 °C) (W)	Limiting element voltage <sup>*2</sup> (V)	Maximum overload voltage <sup>*3</sup> (V)	Resistance tolerance (%)	Resistance range (Ω)	T.C.R. (×10 <sup>-6</sup> /K)	Category temperature range (°C)	AEC-Q200 Grade
ERJXG (01005)	0.031	15	30	±5	1 to 1 M (E24)	R<10Ω : -100 to +600 10Ω to 100Ω : ±300 100Ω≤R : ±200	-55 to +125	-
ERJ1GN (0201)	0.05	25	50	±5	1 to 10 M (E24)	R<10 Ω : -100 to +600 10 Ω to 1 M Ω : ±200 1 MΩ<R : -400 to +150		
ERJ1GJ (0201)	0.05	25	50	±5	1 to 10 M (E24)			-55 to +155
ERJ2G (0402)	0.1	50	100	±5	1 to 10 M (E24)			
ERJ3G (0603)	0.1	75	150	±5	1 to 10 M (E24)			
ERJ6G (0805)	0.125	150	200	±5	1 to 10 M (E24)			Grade 0
<small>NRFND</small> ERJ8G (1206)	0.25	200	400	±5	1 to 10 M (E24)			
<small>NRFND</small> ERJ14 (1210)	0.5	200	400	±5	1 to 10 M (E24)	R<10 Ω : -100 to +600	-55 to +155	Grade 0
<small>NRFND</small> ERJ12 (1812)	0.75	200	500	±5	1 to 10 M (E24)	10 Ω to 1 M Ω : ±200 1 MΩ<R : -400 to +150		
<small>NRFND</small> ERJ12Z (2010)	0.75	200	500	±5	1 to 10 M (E24)			Grade 0
<small>NRFND</small> ERJ1T (2512)	1	200	500	±5	1 to 1 M (E24)			

\*1: Use it on the condition that the case temperature is below the upper category temperature.

\*2: Rated Continuous Working Voltage (RCWV) shall be determined from  $RCWV = \sqrt{\text{Power Rating} \times \text{Resistance Value}}$ , or Limiting Element Voltage listed above, whichever less.

\*3: Overload Test Voltage (OTV) shall be determined from  $OTV = \text{Specified Magnification (refer to performance)} \times RCWV$  or Maximum Overload Voltage listed above, whichever less.

NRFND

Not recommended for new design

### [For Jumper]

Part No.	Resistance(Ω)	Rated current(A)	Maximum overload current (A) <sup>*1</sup>
ERJXG	50 mΩ or less	0.5	1
ERJ1G			
ERJ2G		1	2
ERJ3G			
ERJ6G			
<small>NRFND</small> ERJ8G	50 mΩ or less	2	4
<small>NRFND</small> ERJ14			
<small>NRFND</small> ERJ12		2	4
<small>NRFND</small> ERJ12Z			
<small>NRFND</small> ERJ1T			

\* 1 :Overload test current

### Power derating curve

above 70 °C, power rating shall be derated in accordance with the figure below.

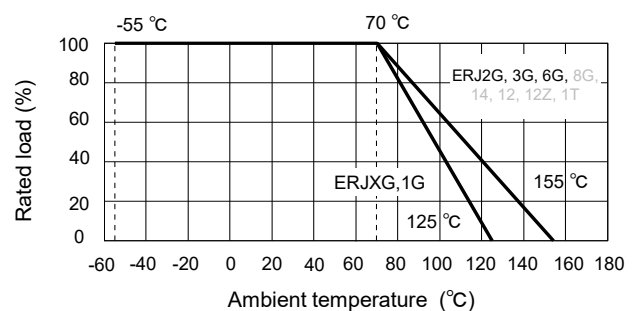

## Construction

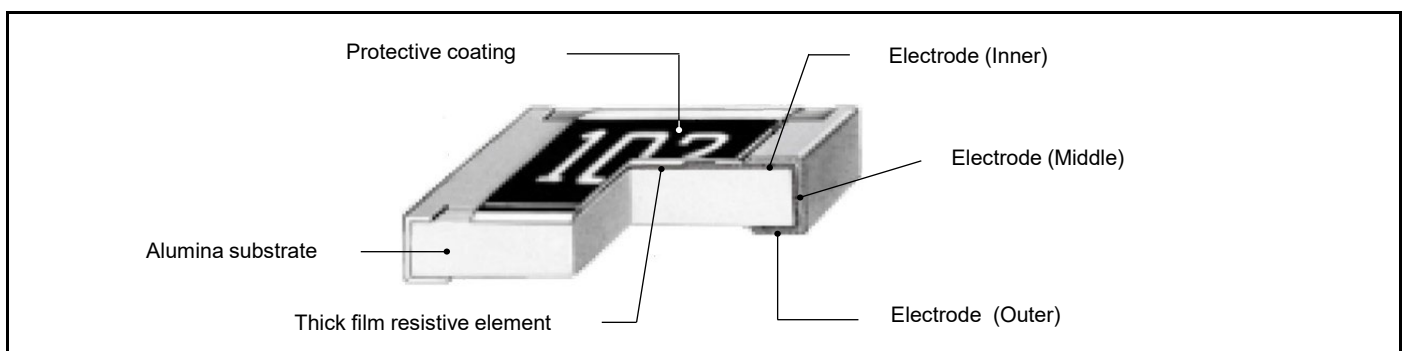



## Dimensions (not to scale)

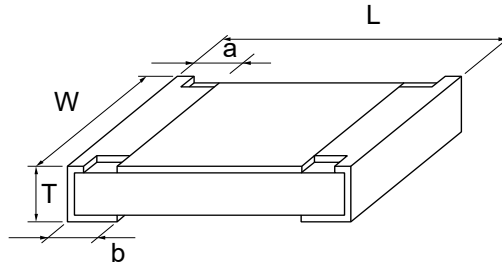

Unit : mm

Part No.	Dimensions					Mass (Weight) (Reference) (g/1000 pcs)
	L	W	a	b	T	
ERJXG	0.40±0.02	0.20±0.02	0.10±0.03	0.10±0.03	0.13±0.02	0.04
ERJ1G	0.60±0.03	0.30±0.03	0.10±0.05	0.15±0.05	0.23±0.03	0.15
ERJ2G	1.00±0.05	0.50±0.05	0.20±0.10	0.25±0.05	0.35±0.05	0.8
ERJ3G	1.60±0.15	0.80±0.15/-0.05	0.30±0.20	0.30±0.15	0.45±0.10	2
ERJ6G	2.00±0.20	1.25±0.10	0.40±0.20	0.40±0.20	0.60±0.10	4
<small>NRFND</small> ERJ8G	3.20±0.05/-0.20	1.60±0.05/-0.15	0.50±0.20	0.50±0.20	0.60±0.10	10
<small>NRFND</small> ERJ14	3.20±0.20	2.50±0.20	0.50±0.20	0.50±0.20	0.60±0.10	16
<small>NRFND</small> ERJ12	4.50±0.20	3.20±0.20	0.50±0.20	0.50±0.20	0.60±0.10	27
<small>NRFND</small> ERJ12Z	5.00±0.20	2.50±0.20	0.60±0.20	0.60±0.20	0.60±0.10	27
<small>NRFND</small> ERJ1T	6.40±0.20	3.20±0.20	0.65±0.20	0.60±0.20	0.60±0.10	45

NRFND

Not recommended for new design

## Performance

Test item	Performance requirements ΔR		Test conditions
	Resistor type	Jumper type	
Resistance	Within specified tolerance	50 mΩ or less	20 °C
T. C. R.	Within specified T. C. R.	50 mΩ or less	+25 °C / +155 °C (ERJXG,1G : +25 °C / +125 °C)
Overload	±2 %	50 mΩ or less	Rated voltage× 2.5, 5 s Jumper type : Max. overload current, 5 s
Resistance to soldering heat	±1 %	50 mΩ or less	270 °C, 10 s
Rapid change of temperature	±1 %	50 mΩ or less	-55 °C (30 min.) / +155 °C (ERJXG,1G : +125 °C) (30 min.), 100 cycles
High temperature exposure	±1 %	50 mΩ or less	+155 °C (ERJXG,1G : +125 °C), 1000 h
Damp heat, Steady state	±1 %	50 mΩ or less	60 °C, 90 % to 95 %RH, 1000 h
Load life in humidity	±3 %	50 mΩ or less	60 °C, 90 % to 95 %RH, Rated voltage (Jumper type : Rated current), 1.5 h ON / 0.5 h OFF cycle, 1000 h
Endurance at 70 °C	±3 %	50 mΩ or less	70 °C, Rated voltage (Jumper type : Rated current), 1.5 h ON / 0.5 h OFF cycle, 1000 h

## Precision Thick Film Chip Resistors

ERJ type

**ERJ XG, 1G** series

**ERJ 1R, 2R, 3R, 6R** series

**ERJ 3E, 6E, 8E, 14, 12, 1T** series

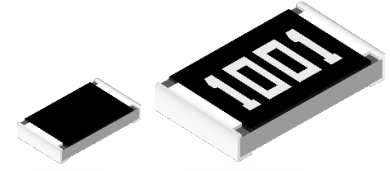

(Oct. 2021) Products marked as "NRFND" are not recommended for new design.  
 Target products : ERJ8E, 14, 12, 1T series  
 Please refer to the recommended alternatives with "Design Support Tool".

### Features

- Small size and lightweight
- High reliability : Metal glaze thick film resistive element and three layers of electrodes
- Compatible with placement machines : Taping packaging available
- Suitable for both reflow and flow soldering
- Low resistance tolerance : ERJXG, 1G, 2R, 3E, 6E, 8E, 14, 12, 1T series : ±1 %  
 ERJ1R, 2R, 3R, 6R series : ±0.5 %
- Reference standard : IEC 60115-8, JIS C 5201-8, JEITA RC-2134C
- AEC-Q200 compliant (except ERJ1R, ERJXG, ERJ1GN)
- RoHS compliant

■ As for packaging methods, land pattern, soldering conditions and safety precautions, please see data files.

### Explanation of part numbers

Note : Please check the "Ratings" for the presence/absence of part numbers for combinations of the symbols below.

- ERJ 1R, 2R, 3R, 6R series : ±0.5 %

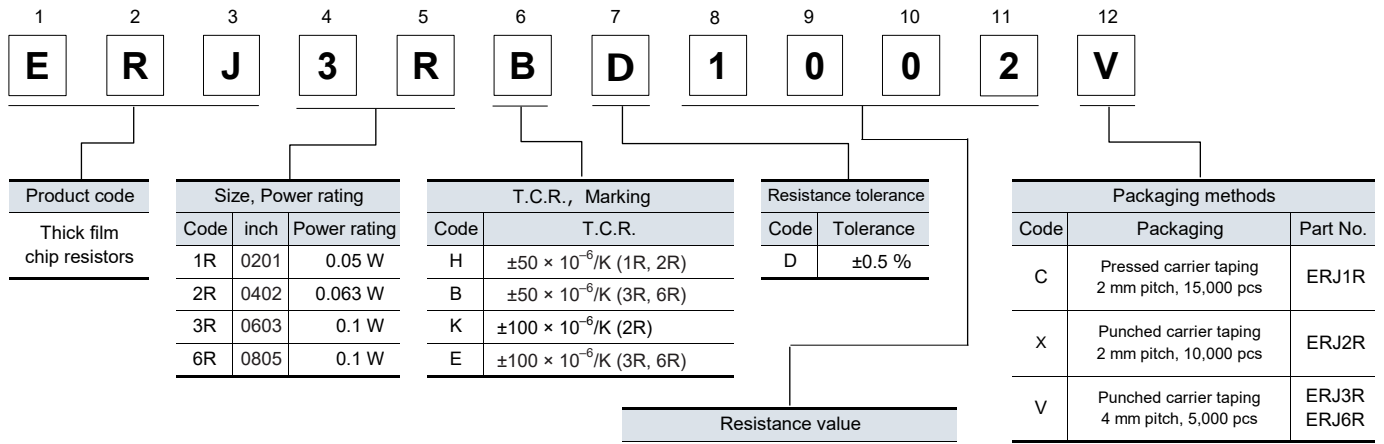

The first three digits are significant figures of resistance and the last one denotes number of zeros following.  
 Example : 1002 → 10 KΩ

## Explanation of part numbers

Note : Please check the "Ratings" for the presence/absence of part numbers for combinations of the symbols below.

### ● ERJ XGN, 1GN, 1GJ, 2RC, 2RK, 3EK, 6EN, 8EN, 14N, 12N, 12S, 1TN series : ±1 %

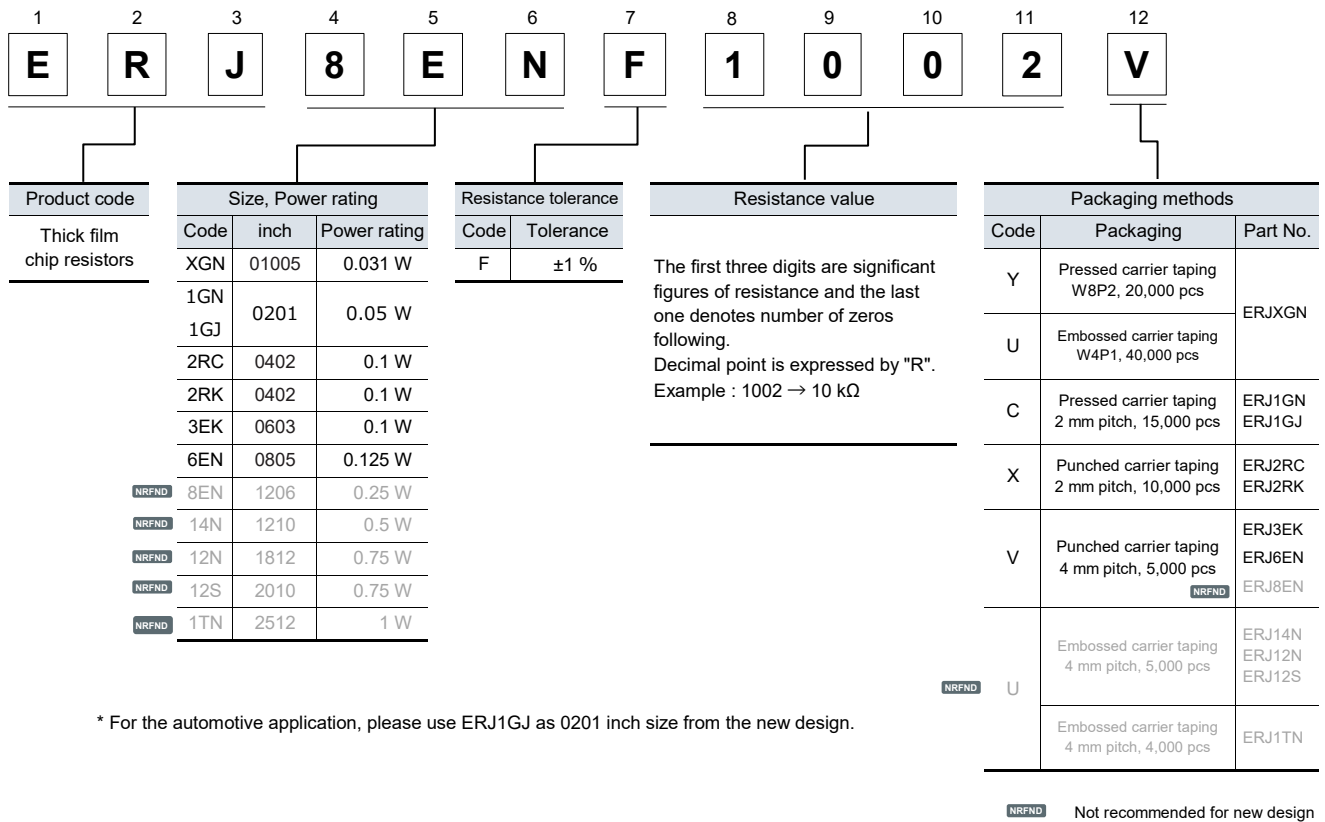

## Ratings

<±0.5 %>

Part No. (inch size)	Rated power <sup>*1</sup> (70 °C) (W)	Limiting element voltage <sup>*2</sup> (V)	Maximum overload voltage <sup>*3</sup> (V)	Resistance tolerance (%)	Resistance range (Ω)	T.C.R. (×10 <sup>-6</sup> /K)	Category temperature range (°C)	AEC-Q200 Grade
ERJ1RH (0201)	0.05	15	30	±0.5	1 k to 1 M (E24,E96)	±50	-55 to +125	-
ERJ2RH (0402)	0.063	50	100	±0.5	100 to 100 k (E24,E96)	±50	-55 to +155	Grade 0
ERJ2RK (0402)	0.063	50	100	±0.5	10 to 97.6 102 k to 1 M (E24,E96)	±100		
ERJ3RB (0603)	0.1	75	150	±0.5	100 to 100 k (E24,E96)	±50		
ERJ3RE (0603)	0.1	75	150	±0.5	10 to 97.6 102 k to 1 M (E24,E96)	±100		
ERJ6RB (0805)	0.1	150	200	±0.5	100 to 100 k (E24,E96)	±50		
ERJ6RE (0805)	0.1	150	200	±0.5	10 to 97.6 102 k to 1 M (E24,E96)	±100		

\*1 : Use it on the condition that the case temperature is below the upper category temperature.

\*2 : Rated continuous working voltage (RCWV) shall be determined from  $RCWV = \sqrt{\text{Power rating} \times \text{Resistance value}}$ , or limiting element voltage listed above, whichever less.

\*3 : Overload test voltage (OTV) shall be determined from  $OTV = \text{specified magnification (refer to performance)} \times RCWV$  or maximum overload voltage listed above, whichever less.

## Ratings

<±1 %>

Part No. (inch size)	Power rating <sup>*1</sup> (70 °C) (W)	Limiting element voltage <sup>*2</sup> (V)	Maximum overload voltage <sup>*3</sup> (V)	Resistance tolerance (%)	Resistance range (Ω)	T.C.R. (×10 <sup>-6</sup> /K)	Category temperature range (°C)	AEC-Q200 Grade
ERJXGN (01005)	0.031	15	30	±1	10 to 1 M <sup>*4</sup> (E24,E96)	R < 100 Ω : ±300 100 Ω ≤ R : ±200	-55 to +125	-
ERJ1GN (0201)	0.05	25	50	±1	10 to 1 M <sup>*4</sup> (E24,E96)	±200		
ERJ1GJ (0201)	0.05	25	50	±1	10 to 1 M <sup>*4</sup> (E24,E96)			
ERJ2RC (0402)	0.1	50	100	±1	1 to 9.76 (E24,E96)	-100 to +600	-55 to +155	Grade 0
ERJ2RK (0402)	0.1	50	100	±1	10 to 1 M (E24,E96)	±100		
ERJ3EK (0603)	0.1	75	150	±1	10 to 1 M (E24,E96)			
ERJ6EN (0805)	0.125	150	200	±1	10 to 2.2 M (E24,E96)			
<small>NRFND</small> ERJ8EN (1206)	0.25	200	400	±1	10 to 2.2 M (E24,E96)	±100	-55 to +155	Grade 0
<small>NRFND</small> ERJ14N (1210)	0.5	200	400	±1	10 to 1 M (E24,E96)			
<small>NRFND</small> ERJ12N (1812)	0.75	200	500	±1	10 to 1 M (E24,E96)			
<small>NRFND</small> ERJ12S (2010)	0.75	200	500	±1	10 to 1 M (E24,E96)			
<small>NRFND</small> ERJ1TN (2512)	1	200	500	±1	10 to 1 M (E24,E96)			

\*1 : Use it on the condition that the case temperature is below the upper category temperature.

\*2 : Rated continuous working voltage (RCWV) shall be determined from  $RCWV = \sqrt{\text{Power rating} \times \text{Resistance value}}$ , or limiting element voltage listed above, whichever less.

\*3 : Overload test voltage (OTV) shall be determined from  $OTV = \text{specified magnification (refer to performance)} \times RCWV$  or maximum overload voltage listed above, whichever less.

\*4 : Please contact us when you need a type with a resistance of less than 10 Ω.

NRFND Not recommended for new design

## Power derating curve

For resistors operated in ambient temperatures above 70 °C, power rating shall be derated in accordance with the figure on the right.

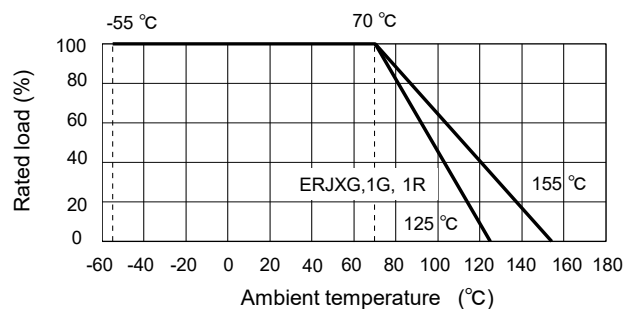

## Construction

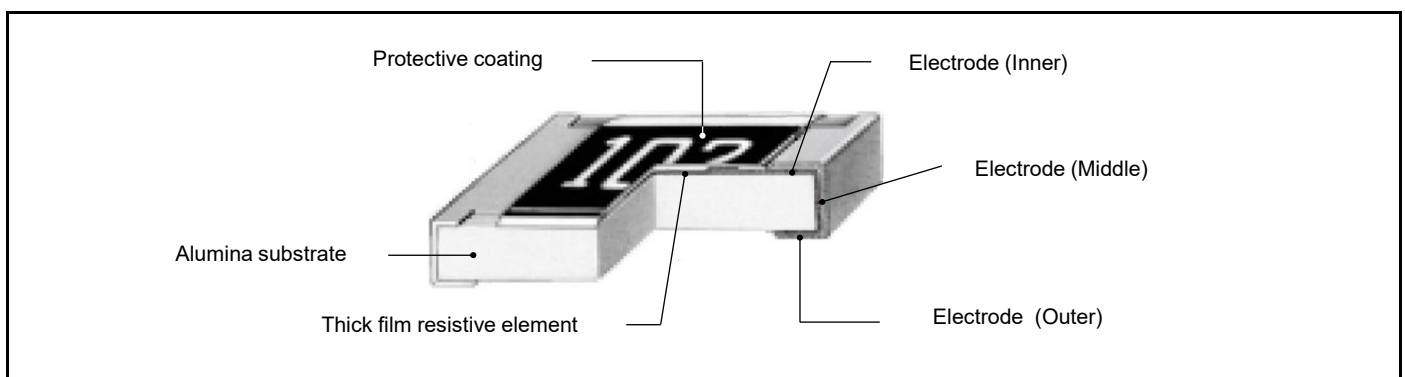

## Precision Thick Film Chip Resistors

### Dimensions (not to scale)

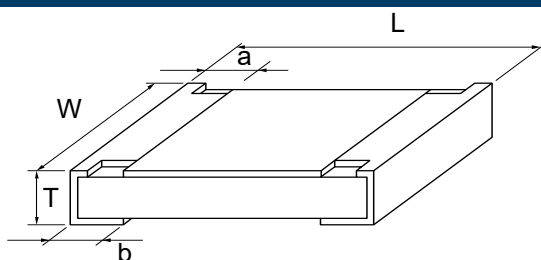

Part No.	Dimensions (mm)					Mass (Weight) (Reference) (g/1000 pcs)
	L	W	a	b	T	
ERJXG	0.40±0.02	0.20±0.02	0.10±0.03	0.10±0.03	0.13±0.02	0.04
ERJ1G	0.60±0.03	0.30±0.03	0.10±0.05	0.15±0.05	0.23±0.03	0.15
ERJ1R						
ERJ2R	1.00±0.05	0.50±0.05	0.20±0.10	0.25±0.05	0.35±0.05	0.8
ERJ3R	1.60±0.15	0.80±0.15/-0.05	0.30±0.20	0.30±0.15	0.45±0.10	2
ERJ3E						
ERJ6R	2.00±0.20	1.25±0.10	0.40±0.20	0.40±0.20	0.60±0.10	4
ERJ6E						
<small>NRFND</small> ERJ8EN	3.20+0.05/-0.20	1.60+0.05/-0.15	0.50±0.20	0.50±0.20	0.60±0.10	10
<small>NRFND</small> ERJ14N	3.20±0.20	2.50±0.20	0.50±0.20	0.50±0.20	0.60±0.10	16
<small>NRFND</small> ERJ12N	4.50±0.20	3.20±0.20	0.50±0.20	0.50±0.20	0.60±0.10	27
<small>NRFND</small> ERJ12S	5.00±0.20	2.50±0.20	0.60±0.20	0.60±0.20	0.60±0.10	27
<small>NRFND</small> ERJ1TN	6.40±0.20	3.20±0.20	0.65±0.20	0.60±0.20	0.60±0.10	45

NRFND Not recommended for new design

### Performance

#### ● ERJ 1R, 2R, 3R, 6R series : ±0.5 % (D)

Test item	Performance requirements ΔR	Test conditions
Resistance	Within specified tolerance	20 °C
T. C. R.	Within specified T. C. R.	+25 °C / +125 °C
Overload	±2 %	Rated voltage × 2.5, 5 s
Resistance to soldering heat	±1 %	270 °C, 10 s
Rapid change of temperature	±1 %	-55 °C (30 min.) / +155 °C (ERJ1R : +125 °C)(30 min.), 100 cycles
High temperature exposure	±1 %	+155 °C (ERJ1R : +125 °C), 1000 h
Damp heat, Steady state	±1 %	60 °C, 90 % to 95 %RH, 1000 h
Load life in humidity	±2 % ERJ1R : ±3 %	60 °C, 90 % to 95 %RH, Rated voltage, 1.5 h ON / 0.5 h OFF cycle, 1000 h
Endurance at 70 °C	±2 % ERJ1R : ±3 %	70 °C, Rated voltage, 1.5 h ON / 0.5 h OFF cycle, 1000 h

#### ● ERJ XGN, 1GN, 1GJ, 2RC, 2RK, 3EK, 6EN, 8EN, 14N, 12N, 12S, 1TN series : ±1 % (F)

Test item	Performance requirements ΔR	Test conditions
Resistance	Within specified tolerance	20 °C
T. C. R.	Within specified T. C. R.	+25 °C / +155 °C (ERJXG, ERJ1G : +25 °C / +125 °C)
Overload	±2 %	Rated voltage × 2.5, 5 s
Resistance to soldering heat	±1 %	270 °C, 10 s
Rapid change of temperature	±1 %	-55 °C (30 min.) / +155 °C (ERJXG, ERJ1G : +125 °C)(30 min.), 100 cycles
High temperature exposure	±1 %	+155 °C (ERJXG, ERJ1G : +125 °C), 1000 h
Damp heat, Steady state	±1 %	60 °C, 90 % to 95 %RH, 1000 h
Load life in humidity	±2 % ERJXG, 1G : ±3 %	60 °C, 90 % to 95 %RH, Rated voltage, 1.5 h ON / 0.5 h OFF cycle, 1000 h
Endurance at 70 °C	±2 % ERJXG, 1G : ±3 %	70 °C, Rated voltage, 1.5 h ON / 0.5 h OFF cycle, 1000 h

# Thin Film Chip Resistors, High Voltage Type

ERA P type

ERA 8P series

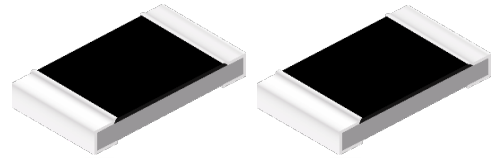

## Features

- High voltage : Achieves high limiting element voltage with original design concept (500V @1MΩ)
- High reliability : Stable at high temperature and humidity  
(85 °C 85 %RH rated load, Category temperature range : -55 °C to +155 °C)
- High accuracy : Low resistance tolerance and temperature coefficient of resistance
- High performance : Low current noise, excellent linearity
- Anti-ESD : Original structure for high ESD performance  
(AEC-Q200-002 HBM Guarantee at 4 kV)
- Anti-sulfurated : Original structure for sulfurated performance
- Reference standard : IEC 60115-8, JIS C 5201-8, JEITA RC-2133C
- RoHS compliant

■ As for packaging methods, land pattern, soldering conditions and safety precautions, please see data files.

## Explanation of part numbers

Note : Please check the "Ratings" for the presence/absence of part numbers for combinations of the symbols below.

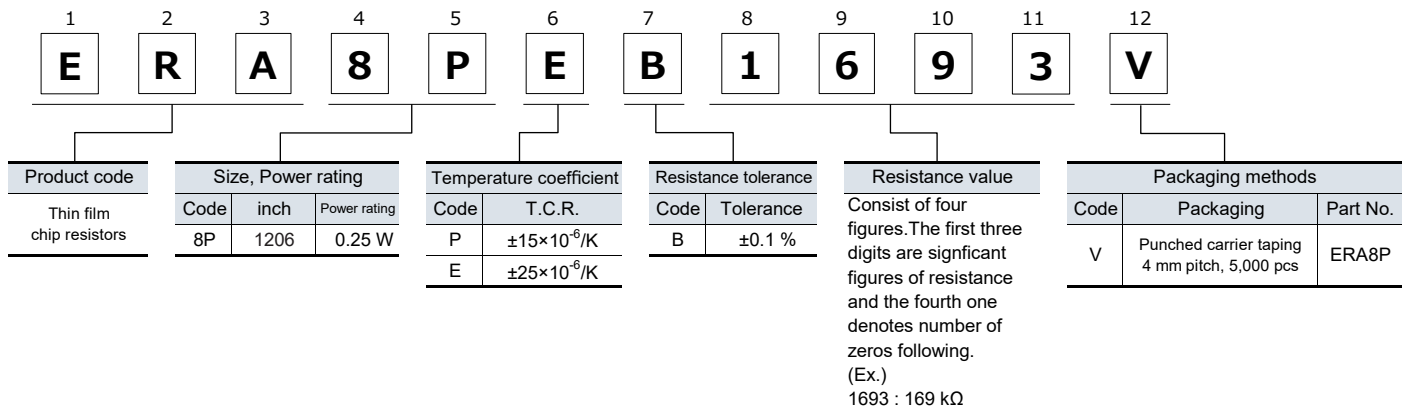

## Ratings

Part No. (inch size)	Power rating at 85 °C <sup>*1</sup> (W)	Limiting element voltage <sup>*2</sup> (V)	Maximum overload voltage (V)	Part No. (detail)	Resistance tolerance (%)	T.C.R. (×10 <sup>-6</sup> /K)	Resistance range <sup>*3</sup> (Ω)	Category temperature range (°C)	AEC-Q200 Grade
ERA8P (1206)	0.25	500	1000	ERA8PEB ERA8PPB	±0.1	±25 ±15	160 k to 1 M (E24, E96)	-55 to +155	Grade 0

\*1: Use it on the condition that the case temperature is below the upper category temperature.

\*2: Rated continuous working voltage (RCWV) shall be determined from  $RCWV = \sqrt{\text{Power Rating} \times \text{Resistance Values}}$ , or limiting element voltage listed above, whichever less.

\*3: E192 series resistance values are also available. The E192 series has custom part numbers. Please contact us for details.

### Power derating curve

For resistors operated in ambient temperatures above 85°C, power rating shall be derated in accordance with the figure on the right.

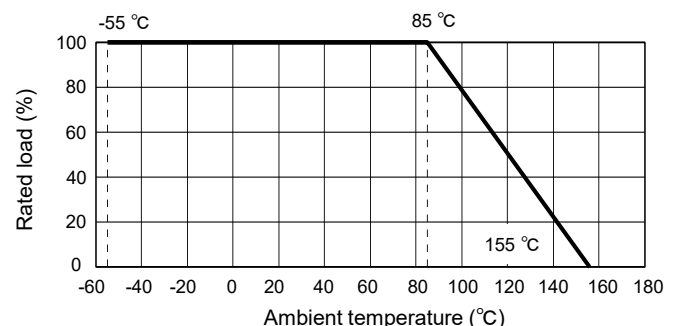

## Thin Film Chip Resistors, High Voltage Type

### Construction

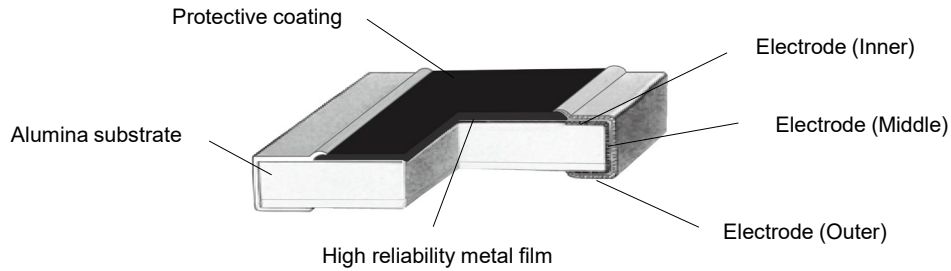

### Dimensions (not to scale)

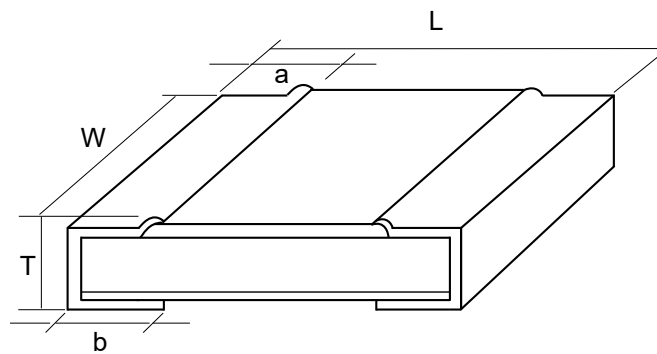

Part No.	Dimensions					Mass (Weight) (Reference) (g/1000 pcs)
	L	W	a	b	T	
ERA8P	3.20±0.20	1.60±0.10	0.50±0.20	0.50±0.20	0.55±0.10	10

Unit : mm

### Performance

Test Item	Performance requirements $\Delta R$	Test conditions
Resistance	Within specified tolerance	20 °C
T. C. R.	Within specified T. C. R.	+25 °C / +125 °C
Overload	±0.1 %	Specified magnification (2.5) × RCWV or Maximum overload voltage, whichever less, 5 s
Resistance to soldering heat	±0.1 %	270 °C, 10 s
Rapid change of temperature	±0.1 %	-55 °C (30 min.) / +155 °C (30 min.), 1000 cycles
High temperature exposure	±0.1 %	+155 °C, 1000 h
Damp heat, Steady state	±0.1 %	85 °C, 85 %RH, 1000 h
Load life in humidity	±0.1 %	85 °C, 85 %RH, 10 % of Rated power <sup>*1</sup> , 1.5 h ON / 0.5 h OFF cycle, 1000 h
Endurance at 85°C	±0.1 %	85 °C, Rated voltage, 1.5 h ON / 0.5 h OFF cycle, 1000 h
Electro static discharge (HBM)	±0.1 %	AEC-Q200-002 : 150 pF, 2000 Ω, positive 5 times, negative 5 times ERA8P : 4.0 kV (Class 3)

\*1: Applied Voltage is " $\sqrt{0.1 \times \text{Power Rating} \times \text{Resistance Values}}$ ".

## Thin Film Chip Resistors, High Stability and Reliability Type

ERA V type

(High resistance value ERA K type)

**ERA 2V, 3V, 6V, 8V** series

(ERA 3K, 6K, 8K series)

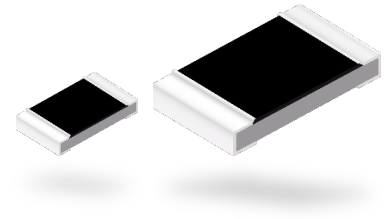

### Features

- High Power : To realize higher power rating, Limiting element voltage, and maximum overload voltage than current products
- High reliability : Stable at high temperature and humidity  
(85 °C 85 %RH rated load, Category temperature range : -55 °C to +155 °C)
- High accuracy : Low resistance tolerance and temperature coefficient of resistance
- High performance : Low current noise, excellent linearity
- Anti-ESD : Original structure for high ESD performance  
(AEC-Q200-002 HBM Class 1c and above)
- Anti-sulfurated : Original structure for sulfurated performance
- Reference standard : IEC 60115-8, JIS C 5201-8, JEITA RC-2133C
- RoHS compliant

■ As for packaging methods, land pattern, soldering conditions and safety precautions, please see data files.

### Explanation of part numbers

Note : Please check the "Ratings" for the presence/absence of part numbers for combinations of the symbols below.

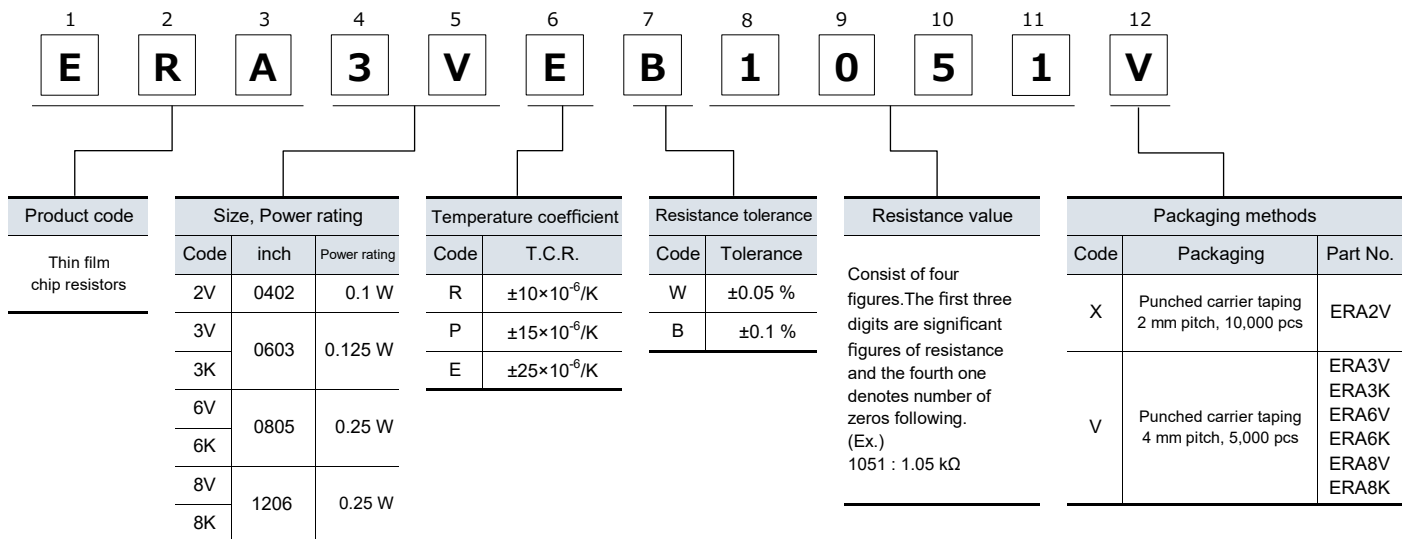



## Thin Film Chip Resistors, High Stability and Reliability Type

### Ratings

Part No. (inch size)	Power rating at 85 °C <sup>*1</sup> (W)	Limiting element voltage <sup>*2</sup> (V)	Maximum overload voltage <sup>*3</sup> (V)	Part No. (detail)	Resistance tolerance (%)	T.C.R. (×10 <sup>-6</sup> /K)	Resistance range <sup>*4</sup> (Ω)	Category temperature range (°C)	AEC-Q200 Grade
ERA2V (0402)	0.1	75	150	ERA2VEB	±0.1	±25	47 to 100 k <sup>*5</sup> (E24, E96)	-55 to +155	Grade 0
				ERA2VPB	±0.1	±15	1 k to 47 k <sup>*5</sup> (E24, E96)		
				ERA2VRB	±0.1	±10			
				ERA2VRW	±0.05				
ERA3V (0603)	0.125	100	200	ERA3VEB	±0.1	±25	47 to 100 k (E24, E96)		
				ERA3VPB	±0.1	±15	1 k to 100 k (E24, E96)		
				ERA3VRB	±0.1	±10			
				ERA3VRW	±0.05				
ERA3K (0603)	0.125	100	200	ERA3KEB	±0.1	±25	102 k to 240 k (E24, E96)		
ERA6V (0805)	0.25	150	300	ERA6VEB	±0.1	±25	47 to 100 k (E24, E96)		
				ERA6VPB	±0.1	±15	1 k to 100 k (E24, E96)		
				ERA6VRB	±0.1	±10			
				ERA6VRW	±0.05				
ERA6K (0805)	0.25	150	300	ERA6KEB	±0.1	±25	102 k to 750 k (E24, E96)		
ERA8V (1206)	0.25	200	400	ERA8VEB	±0.1	±25	47 to 100 k (E24, E96)		
				ERA8VPB		±15	1 k to 100 k (E24, E96)		
				ERA8VRB	±0.05	±10	1 k to 100 k (E24, E96)		
				ERA8VRW		±10	102 k to 1 M (E24, E96)		
ERA8K (1206)	0.25	200	400	ERA8KEB	±0.1	±25	102 k to 160 k (E24, E96)		
				ERA8KPB		±15			
				ERA8KRB	±0.05	±10			
				ERA8KRW					

\*1: Use it on the condition that the case temperature is below the upper category temperature.

\*2: Rated Continuous Working Voltage (RCWV) shall be determined from  $RCWV = \sqrt{\text{Power Rating} \times \text{Resistance Values}}$ , or Limiting Element Voltage listed above, whichever less.

\*3: Overload Test Voltage (OTV) shall be determined from  $OTV = \text{Specified Magnification (2.5)} \times RCWV$  or Maximum Overload Voltage listed above, whichever less.

\*4: E192 series resistance values are also available. The E192 series has custom part numbers. Please contact us for details.

\*5: Expanded resistance range

### Power derating curve

For resistors operated in ambient temperatures above 85°C, power rating shall be derated in accordance with the figure on the right.

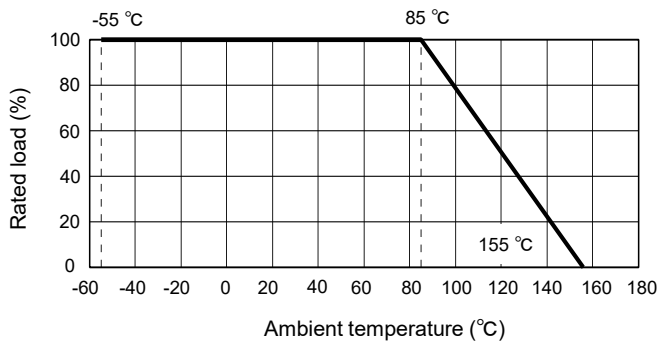

### Construction

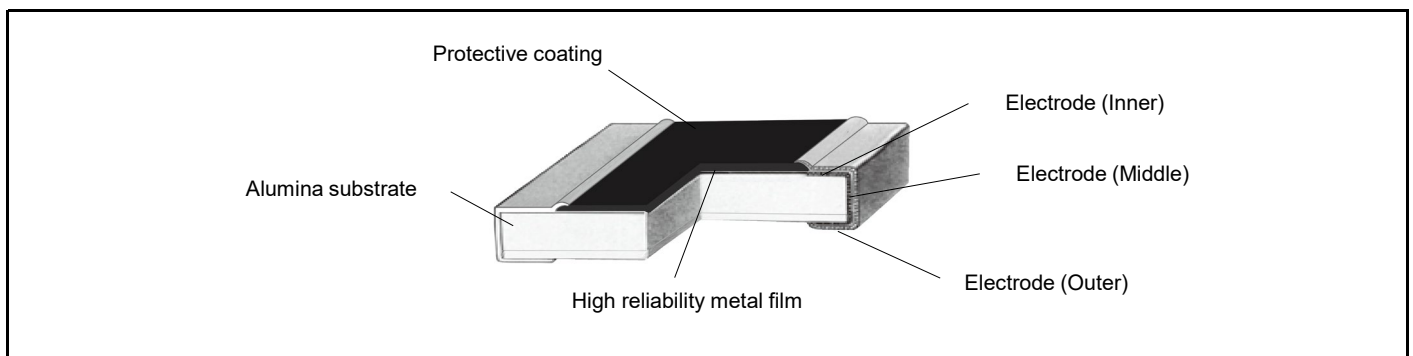

## Thin Film Chip Resistors, High Stability and Reliability Type

### Dimensions (not to scale)

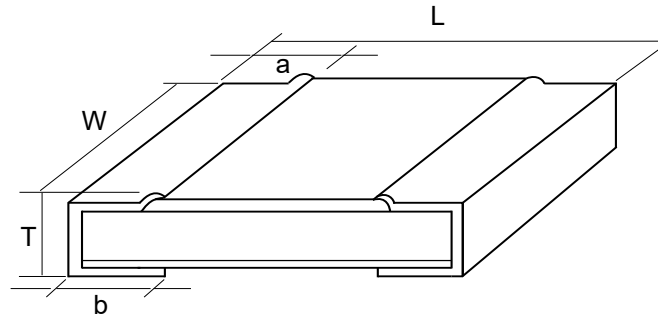

Part No.	Dimensions					Unit : mm
	L	W	a	b	T	Mass (Weight) (Reference) (g/1000 pcs)
ERA2V	1.00±0.05	0.50+0.10/-0.05	0.25±0.10	0.25±0.10	0.35±0.05	0.6
ERA3V,3K	1.60±0.15	0.80±0.10	0.30±0.20	0.30±0.20	0.45±0.10	2
ERA6V,6K	2.00±0.20	1.25±0.10	0.40±0.20	0.40±0.20	0.55±0.10	5
ERA8V,8K	3.20±0.20	1.60±0.10	0.50±0.20	0.50±0.20	0.55±0.10	10

### Performance

Test Item	Performance requirements $\Delta R$	Test conditions
Resistance	Within specified tolerance	20 °C
T. C. R.	Within specified T. C. R.	+25 °C / +125 °C
Overload	±0.1 %	Rated voltage× 2.5, 5 s
Resistance to soldering heat	±0.1 %	270 °C, 10 s
Rapid change of temperature	±0.1 %	-55 °C (30 min.) / +155 °C (30 min.), 1000 cycles
High temperature exposure	±0.1 %	+155 °C, 1000 h
Damp heat, Steady state	±0.1 %	85 °C, 85 %RH, 1000 h
Load life in humidity	±0.1 %	85 °C, 85 %RH, 10 % of Rated power <sup>*1</sup> , 1.5 h ON / 0.5 h OFF cycle , 1000 h
Endurance at 85°C	±0.1 %	85 °C, Rated voltage, 1.5 h ON / 0.5 h OFF cycle, 1000 h
Electro static discharge (HBM)	±0.1 % <sup>*2</sup>	AEC-Q200-002 : 150 pF, 2000 Ω, positive 5 times, negative 5 times ERA2V : 1.0 kV (Class 1c) ERA3V(3K) : 1.5 kV (Class 1c) ERA6V(6K) : 2.0 kV (Class 2) ERA8V(8K) : 2.0 kV (Class 2)

\*1: Applied Voltage is " $\sqrt{0.1 \times \text{Power Rating} \times \text{Resistance Values}}$ ", or "Limiting Element Voltage×0.316", whichever less.

\*2: Depends on resistance value.

# Metal Film (Thin Film) Chip Resistors, High Reliability Type

ERA A type

ERA 1A, 2A, 3A, 6A, 8A series

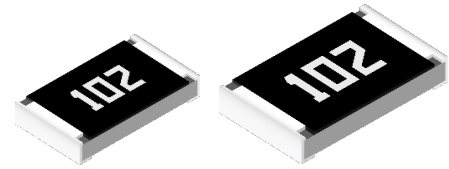

## Features

- High reliability : Stable at high temperature and humidity  
(85 °C 85 %RH rated load, Category temperature range : -55 °C to +155 °C)
  - High accuracy : Low resistance tolerance and Temperature Coefficient of Resistance
  - High performance : Low current noise, excellent linearity
  - Reference standard : IEC 60115-8, JIS C 5201-8, JEITA RC-2133C
  - AEC-Q200 compliant
  - RoHS compliant
- As for packaging methods, land pattern, soldering conditions and safety precautions, please see data files.

## Explanation of part numbers

Note : Please check the "Ratings" for the presence/absence of part numbers for combinations of the symbols below.

### ● E24 series

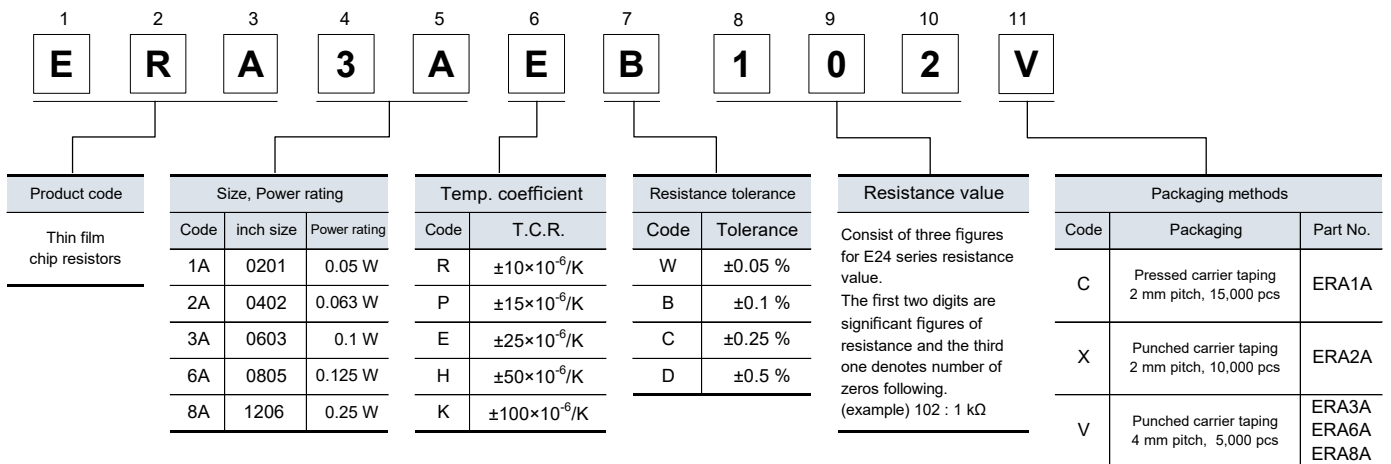

### ● E96 series and other Resistance values

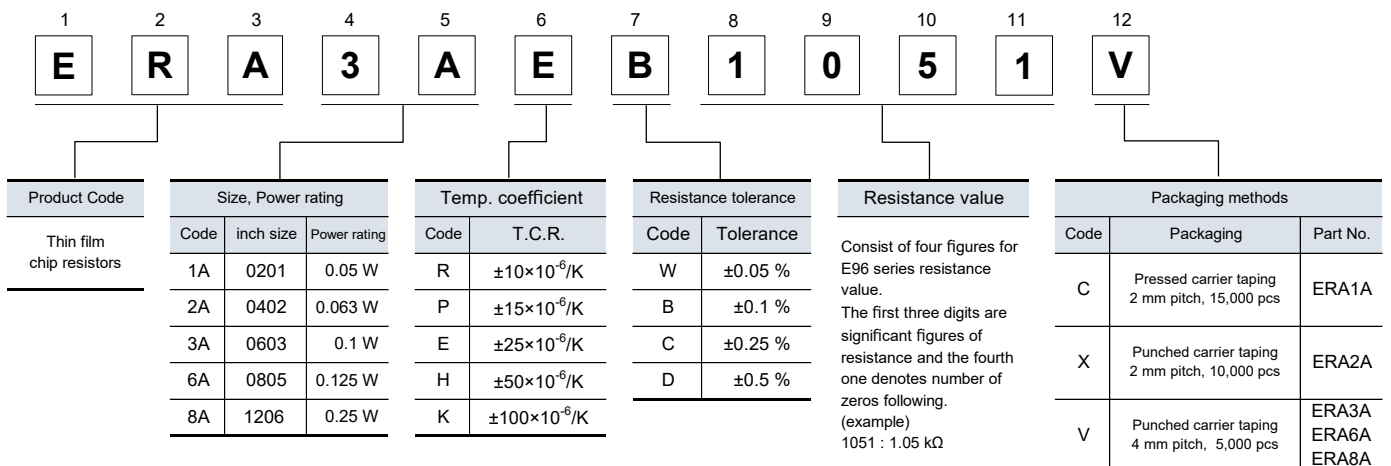

Note : Duplicated resistance values as E24 series part numbers shall follow E24 part numbers.  
(apply three digit resistance value)

## Metal Film (Thin Film) Chip Resistors, High Reliability Type

### Ratings

Part No. (inch size)	Power rating <sup>*1</sup> (85 °C) (W)	Limiting element voltage <sup>*2</sup> (V)	Maximum overload voltage <sup>*3</sup> (V)	Part No. (detail)	Resistance tolerance (%)	T.C.R. (×10 <sup>-6</sup> /K)	Resistance range <sup>*4 *5</sup> (Ω)	Category temperature range (°C)	AEC-Q200 Grade
ERA1A (0201)	0.05	25	50	ERA1AEB	±0.1	±25	100 to 10 k (E24,E96)	-55 to +155	Grade 1
				ERA1AEC	±0.25				
				ERA1ARC	±0.25	±10	100 to 10 k (E24,E96)		
				ERA1ARB	±0.1				
ERA1ARW	±0.05	1 k to 10 k (E24,E96)							
ERA2A (0402)	0.063	50	100	ERA2AKD	±0.5	±100	10 to 46.4 (E24,E96)		
				ERA2AED	±0.5	±25	47 to 100 k (E24,E96)		
				ERA2AEC	±0.25				
				ERA2AEB	±0.1	±15	200 to 47 k (E24,E96)		
				ERA2APC	±0.25				
				ERA2APB	±0.1	±10	200 to 47 k (E24,E96)		
				ERA2ARC	±0.25				
ERA2ARB	±0.1								
ERA3A (0603)	0.1	75	150	ERA3AHD	±0.5	±50	10 to 46.4 (E24,E96)		
				ERA3AED	±0.5	±25	47 to 330 k (E24,E96)		
				ERA3AEC	±0.25				
				ERA3AEB	±0.1	±15	470 to 100 k (E24,E96)		
				ERA3APC	±0.25				
				ERA3APB	±0.1	±10	1 k to 100 k (E24,E96)		
				ERA3ARC	±0.25				
ERA3ARB	±0.1								
ERA3ARW	±0.05								
ERA6A (0805)	0.125	100	200	ERA6AHD	±0.5	±50	10 to 46.4 (E24,E96)		
				ERA6AED	±0.5	±25	47 to 1 M (E24,E96)		
				ERA6AEC	±0.25				
				ERA6AEB	±0.1	±15	470 to 100 k (E24,E96)		
				ERA6APC	±0.25				
				ERA6APB	±0.1	±10	1 k to 100 k (E24,E96)		
				ERA6ARC	±0.25				
ERA6ARB	±0.1								
ERA6ARW	±0.05								
ERA8A (1206)	0.25	150	300	ERA8AHD	±0.5	±50	10 to 46.4 (E24,E96)		
				ERA8AED	±0.5	±25	47 to 1 M (E24,E96)		
				ERA8AEC	±0.25				
				ERA8AEB	±0.1	±15	470 to 100 k (E24,E96)		
				ERA8APC	±0.25				
				ERA8APB	±0.1	±10	1 k to 100 k (E24,E96)		
				ERA8ARC	±0.25				
ERA8ARB	±0.1								
ERA8ARW	±0.05								

\*1: Use it on the condition that the case temperature is below the upper category temperature.

\*2: Rated Continuous Working Voltage (RCWV) shall be determined from  $RCWV = \sqrt{\text{Power Rating} \times \text{Resistance Values}}$ , or Limiting Element Voltage listed above, whichever less.

\*3: Overload Test Voltage (OTV) shall be determined from  $OTV = \text{Specified Magnification (2.5)} \times RCWV$  or Maximum Overload Voltage listed above, whichever less.

\*4: E192 series resistance values are also available. Please contact us for details.

\*5: Duplicated resistance values between E96, E192 and E24 series shall follow E24 Part Numbers. (apply three digit resistance value)

### Power derating curve

For resistors operated in ambient temperatures above 85 °C, power rating shall be derated in accordance with the figure on the right.

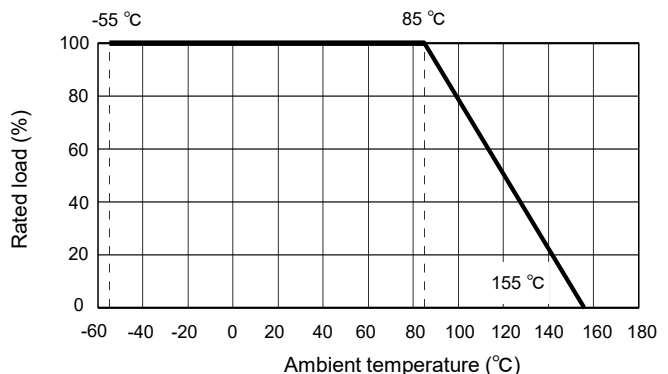

## Metal Film (Thin Film) Chip Resistors, High Reliability Type

### Construction

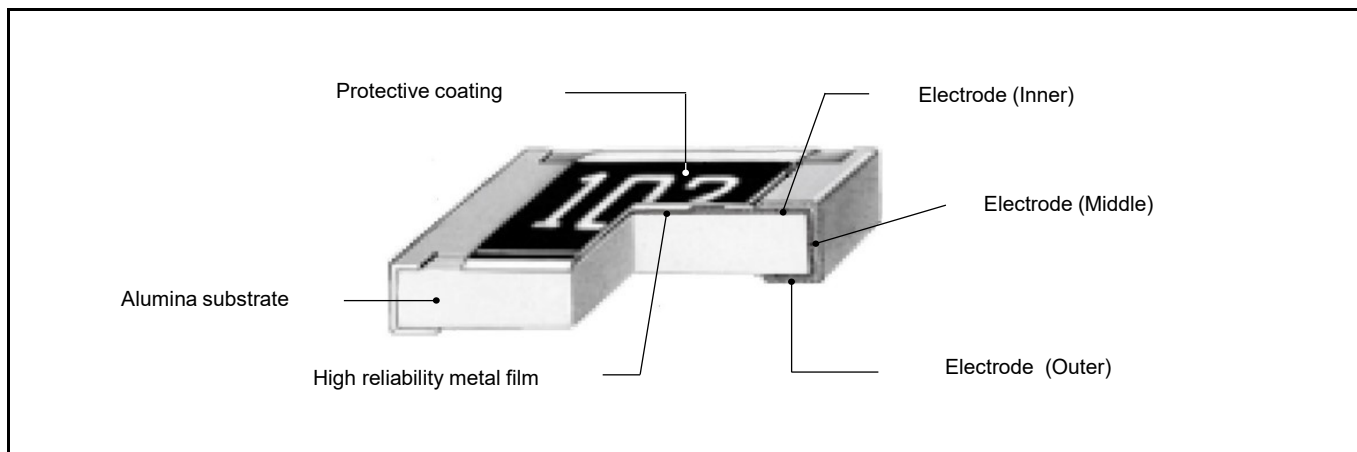

\*0201/0402 size or E96 series do not have value markings.

### Dimensions (not to scale)

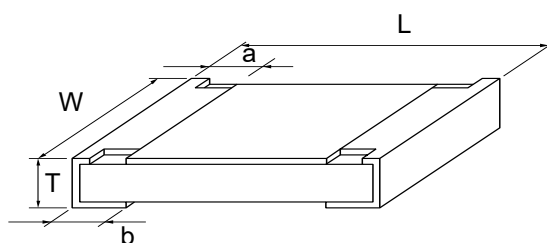

Unit : mm

Part No.	Dimensions					Mass (Weight) (Reference) (g/1000 pcs)
	L	W	a	b	T	
ERA1A	0.60±0.03	0.30±0.03	0.15±0.05	0.15±0.05	0.23±0.03	0.14
ERA2A	1.00±0.10	0.50±0.10/-0.05	0.15±0.10	0.25±0.10	0.35±0.05	0.6
ERA3A	1.60±0.20	0.80±0.20	0.30±0.20	0.30±0.20	0.45±0.10	2
ERA6A	2.00±0.20	1.25±0.10	0.40±0.25	0.40±0.25	0.50±0.10	4
ERA8A	3.20±0.20	1.60±0.05/-0.15	0.50±0.25	0.50±0.25	0.60±0.10	8

### Performance

Test Item	Performance requirements $\Delta R$	Test conditions
Resistance	Within specified tolerance	20 °C
T. C. R.	Within specified T. C. R.	+25 °C / +125 °C
Overload	R<47 Ω : ±0.5 % R≥47Ω : ±0.1 %	Rated voltage x 2.5, 5 s
Resistance to soldering heat	R<47 Ω : ±0.5 % R≥47Ω : ±0.1 %	270 °C, 10 s
Rapid change of temperature	R<47 Ω : ±0.5 % R≥47Ω : ±0.1 %	ERA1A, 2A : -55 °C (30 min.) / +125 °C (30 min.), 1000 cycles ERA3A, 6A, 8A : -55 °C (30 min.) / +155 °C (30 min.), 1000 cycles
High temperature exposure	R<47 Ω : ±0.5 % R≥47Ω : ±0.1 %	+155 °C, 1000 h
Damp heat, Steady state	R<47 Ω : ±0.5 % R≥47Ω : ±0.1 %	85 °C, 85 %RH, 1000 h
Load life in humidity	R<47 Ω : ±0.5 % R≥47Ω : ±0.1 %	85 °C, 85%RH, 10% rated power, 1.5 h ON / 0.5 h OFF cycle, 1000 h, Max. test voltage : ERA2A : 15.8 V, ERA3A : 23.7 V, ERA6A : 31.6 V, ERA8A : 47.4 V
Endurance at 85°C	R<47 Ω : ±0.5 % R≥47Ω : ±0.1 %	85°C, Rated voltage, 1.5 h ON / 0.5 h OFF cycle, 1000 h

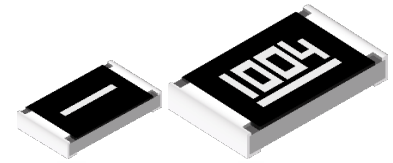

## High Precision Thick Film Chip Resistors

ERJ PB type

ERJ PB3, PB6 series

### Features

- Achieve the resistance tolerance  $\pm 0.1\%$  with high reliability metal glaze thick film resistor
- Guarantee the temperature coefficient of Resistance  $\pm 50 \times 10^{-6}/K$  in high resistance range up to 1 M $\Omega$
- High power : 0.20 W : 0603 inch /1608 mm size(ERJPB3)  
: 0.25 W : 0805 inch /2012 mm size(ERJPB6)
- Reference Standard : IEC 60115-8, JIS C 5201-8, JEITA RC-2134C
- AEC-Q200 compliant
- RoHS compliant

■ As for packaging methods, land pattern, soldering conditions and safety precautions, please see data files.

### Explanation of part numbers

Note : Please check the "Ratings" for the presence/absence of part numbers for combinations of the symbols below.

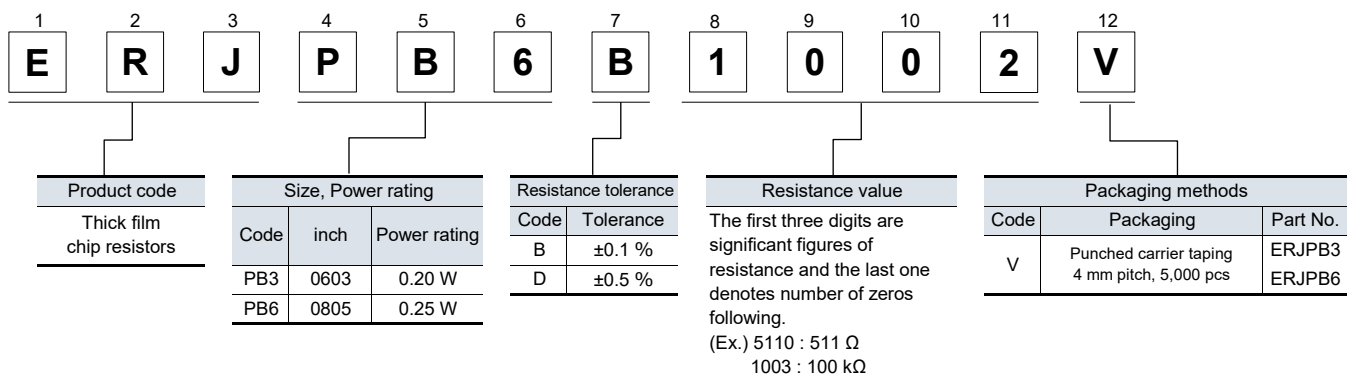

### Ratings

Part No. (inch size)	Power rating <sup>*1</sup> (70 °C)(W)	Limiting element voltage <sup>*2</sup> (V)	Maximum overload voltage <sup>*3</sup> (V)	Resistance tolerance (%)	Resistance range ( $\Omega$ )	T.C.R. ( $\times 10^{-6}/K$ )	Category temperature range (°C)	AEC-Q200 Grade
ERJPB3 (0603)	0.20	150	200	$\pm 0.1$ $\pm 0.5$	200 to 100 k (E24, E96)	$\pm 50$	-55 to +155	Grade 0
ERJPB6 (0805)	0.25	150	200	$\pm 0.1$ $\pm 0.5$	200 to 1 M (E24, E96)	$\pm 50$		

\*1: Use it on the condition that the case temperature is below the upper category temperature.

\*2: Rated continuous working voltage (RCWV) shall be determined from  $RCWV = \sqrt{\text{Power rating} \times \text{Resistance value}}$ , or Limiting Element Voltage listed above, whichever less.

\*3: Overload Test Voltage (OTV) shall be determined from  $OTV = \text{Specified Magnification (refer to performance)} \times RCWV$  or Maximum overload voltage listed above, whichever less.

#### Power derating curve

For resistors operated in ambient temperatures above 70 °C, power rating shall be derated in accordance with the figure on the right.

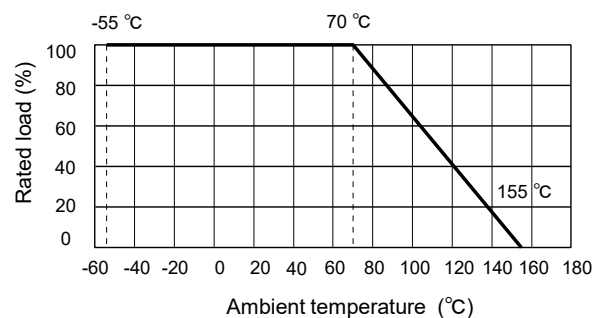

## Construction

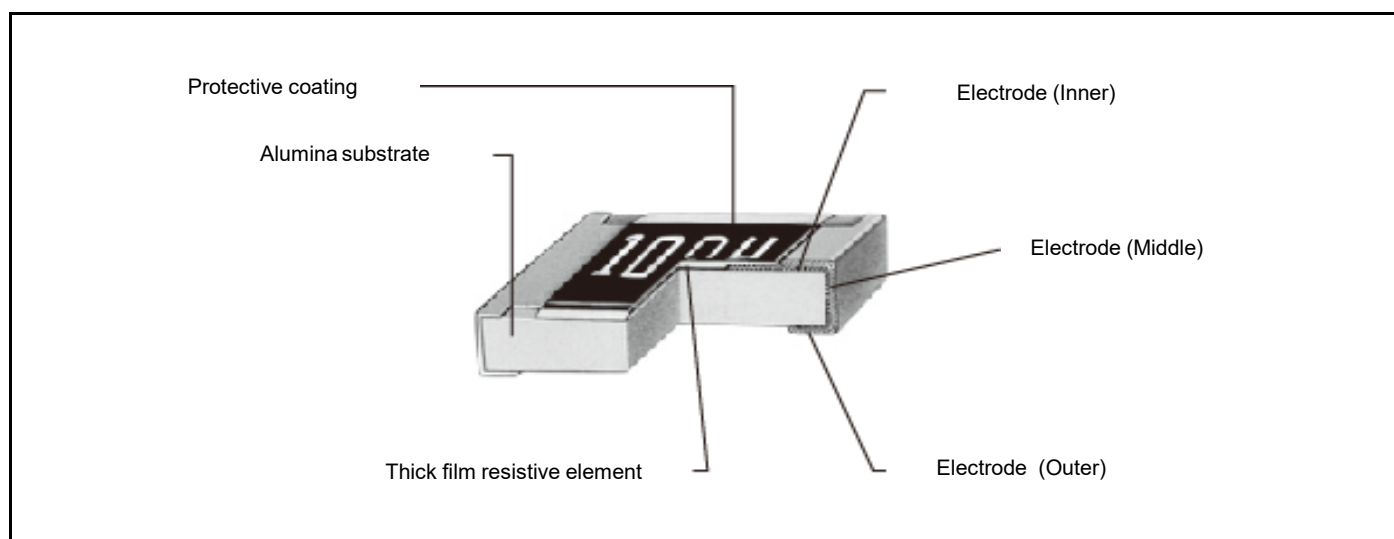

## Dimensions (not to scale)

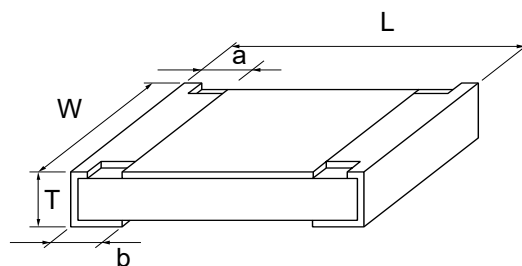

Unit : mm

Part No.	Dimensions					Mass (Weight) (Reference) (g/1000 pcs)
	L	W	a	b	T	
ERJPB3	1.60±0.15	0.80+0.15/-0.05	0.15+0.15/-0.10	0.25±0.10	0.45±0.10	2
ERJPB6	2.00±0.20	1.25±0.10	0.25±0.20	0.40±0.20	0.60±0.10	4

## Performance

Test Item	Performance requirements $\Delta R$	Test conditions
Resistance	Within specified tolerance	20 °C
T. C. R.	Within specified T. C. R.	+25 °C / +125 °C
Overload	±0.5 %	Rated voltage × 2.0, 5 s
Resistance to soldering heat	±0.5 %	270 °C, 10 s
Rapid change of temperature	±0.5 %	-55 °C (30 min.) / +155 °C (30 min.), 100 cycles
High temperature exposure	±0.5 %	+155 °C, 1000 h
Damp heat, Steady state	±0.5 %	60 °C, 90 % to 95 %RH, 1000 h
Load life in humidity	±0.5 %	60 °C, 90 % to 95 %RH, Rated voltage, 1.5 h ON / 0.5 h OFF cycle, 1000 h
Endurance at 70 °C	±0.5 %	70 °C, Rated voltage, 1.5 h ON / 0.5 h OFF cycle, 1000 h

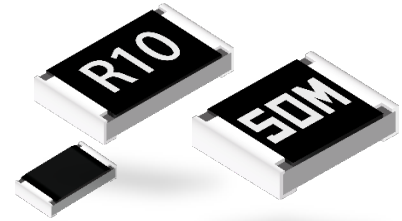

## Thick Film Chip Resistors (Low Resistance Type)

ERJ type

**ERJ 2LW, 3LW, 6LW** series

**ERJ 2BW, 3BW, 6BW, 8BW, 6CW, 8CW** series

**ERJ 2BS/Q, 3BS/Q, 6DS/Q, 6BS/Q, 8BS/Q, 14BS/Q** series

**ERJ 3RS/Q, 6RS/Q, 8RS/Q, 14RS/Q, 12RS/Q, 12ZS/Q, 1TRS/Q** series

**ERJ L03, L06, L08, L14, L12, L1D** series

### Features

- Current sensing resistor
- Small size and lightweight
- Realize both low-resistance & High-precision by original thick film resistive element & special electrode structure
- Suitable for both reflow and flow soldering
- Realize High-power by double-sided resistive elements structure that aimed to suppress temperature rising  
: ERJ2LW, 3LW, 6LW, 2BW, 3BW, 6BW, 8BW, 6CW, 8CW
- Low TCR :  $\pm 75 \times 10^{-6} / K$  (ERJ6CW, ERJ8CW)
- Low resistance value : Thick film resistors available from 5 mΩ (ERJ3LW, 6LW)
- Reference standard : IEC 60115-8, JIS C 5201-8, JEITA RC-2144
- AEC-Q200 compliant
- RoHS compliant

■ As for packaging methods, land pattern, soldering conditions and safety precautions, please see data files.

### Explanation of part numbers

Note : Please check the "Ratings" for the presence/absence of part numbers for combinations of the symbols below.

- ERJ 2LW, 3LW, 6LW, 2BW, 3BW, 6BW, 8BW, 6CW, 8CW series

<High power (double-sided resistive elements structure) type>

1	2	3	4	5	6	7	8	9	10	11	12		
E	R	J	2	B	W	G	R	0	4	7	X		
Product code Thick film chip resistors			Code	inch size	Power rating	Resistance value	Resistance tolerance		Resistance value		Packaging methods		
			2LW	0402	0.2 W	10 mΩ	Code	Tolerance	Shown by 4 digits or letters. (Ex.) R005 : 0.005 Ω = 5 mΩ R047 : 0.047 Ω = 47 mΩ		Code	Packaging	Part No.
			3LW	0603	0.25 W	5 mΩ, 10 mΩ	D	±0.5 %*			X	Pressed carrier taping 2 mm pitch, 10,000 pcs	ERJ2LW ERJ2BW
			6LW	0805	0.5 W	5, 6, 7, 8, 9 mΩ	F	±1 %			V	Punched carrier taping 4 mm pitch, 5,000 pcs	ERJ3LW ERJ6LW ERJ3BW ERJ6BW ERJ8BW ERJ6CW ERJ8CW
			2BW	0402	0.25 W	47 m to 100 mΩ	G	±2 %					
			3BW	0603	0.33 W	20 m to 100 mΩ	J	±5 %					
			6BW	0805	0.5 W	10 m to 100 mΩ	*Please refer to the rating table for the resistance tolerance.						
			8BW	1206	1 W	10 m to 100 mΩ							
			6CW	0805	0.5 W	10 m to 30 mΩ							
			8CW	1206	1 W	10 m to 50 mΩ							



# Thick Film Chip Resistors (Low Resistance Type)

## Explanation of part numbers

Note : Please check the "Ratings" for the presence/absence of part numbers for combinations of the symbols below.

- ERJ 2BS/Q, 3BS/Q, 6BS/Q, 8BS/Q, 14BS/Q, 6DDS/Q, 3RS/Q, 6RS/Q, 8RS/Q, 14RS/Q, 12RS/Q, 12ZS/Q, 1TRS/Q series <High power type/Standard type>

1	2	3	4	5	6	7	8	9	10	11	
E	R	J	8	R	Q	F	R	2	2	V	
<b>Product code</b> Thick film chip resistors	<b>Size, Power rating</b>			<b>Resistance value region</b>		<b>Resistance tolerance</b>		<b>Resistance value</b>	<b>Packaging methods</b>		
	Code	inch size	Power rating	S	0.1Ω to 0.2Ω	D	±0.5 %*	Shown by 3 digits or letters. Only when it is D (E24,E96) or F (E96), shown by 4 digits or letters. (Ex.) R22 : 0.22 Ω R102 : 0.102 Ω	Code	Packaging	Part No.
	2B	0402	0.166 W	Q	0.22Ω to 9.1Ω	F	±1 %		X	Punched carrier taping 2 mm pitch, 10,000 pcs	ERJ2B
	3B	0603	0.25 W	*2B:0.22 Ω to 1.0 Ω		G	±2 %	V	V	Punched carrier taping 4 mm pitch, 5,000 pcs	ERJ3B/3R
	3R	0603	0.1 W			J	±5 %				ERJ6D/6B/ ERJ6R ERJ8B/8R
	6D	0805	0.5 W			*Please refer to the rating table for the resistance tolerance.		U	U	Embossed carrier taping 4 mm pitch, 5,000 pcs	ERJ14B/14R ERJ12R ERJ12Z
	6B	0805	0.33 W								Embossed carrier taping 4 mm pitch, 4,000 pcs
	6R	0805	0.125 W								
	8B	1206	0.5 W								
	8R	1206	0.25 W								
	14B	1210	0.5 W								
	14R	1210	0.25 W								
	12R	1812	0.5 W								
	12Z	2010	0.5 W								
	1TR	2512	1 W								

- ERJ L03, L06, L08, L14, L12, L1D series <Low TCR type>

1	2	3	4	5	6	7	8	9	10	11	12	
E	R	J	L	1	4	K	J	5	0	M	U	
<b>Product Code</b> Thick film chip resistors	<b>Size, Power rating</b>			<b>Code</b>	<b>Resistance value</b>		<b>Resistance tolerance</b>		<b>Resistance value</b>	<b>Packaging methods</b>		
	Code	inch size	Power rating	K	Standard *		F	±1 %	Shown by 3 digits or letters. (Ex.) 50M : 50 mΩ 10C : 100 mΩ	V	Punched carrier taping 4 mm pitch, 5,000 pcs	Part No. ERJL03 ERJL06 ERJL08
	L03	0603	0.2 W		20 mΩ, 22 mΩ, 33 mΩ, 39 mΩ, 47 mΩ, 50 mΩ, 100 mΩ		J	±5 %				
	L06	0805	0.25 W	U	20 mΩ to 100 mΩ*				U	Embossed carrier taping 4 mm pitch, 5,000 pcs	ERJL14 ERJL12 ERJL1D	
	L08	1206	0.33 W		*L03, L06, L08 : 47 mΩ to 100 mΩ L1D : 40 mΩ to 100 mΩ							
	L14	1210	0.33 W									
	L12	1812	0.5 W									
	L1D	2010	0.5 W									

## Ratings

### <High power (double-sided resistive elements structure) type>

Part No. (inch size)	Power rating (70 °C) <sup>*1</sup> (W)	Resistance tolerance (%)	Resistance range <sup>*2</sup> (Ω)	T.C.R. (×10 <sup>-6</sup> /K)	Category temperature range(°C)	AEC-Q200 Grade
ERJ2LW (0402)	0.2	±1, ±2, ±5	10 m	0 to +500	-55 to +125	Grade 1
ERJ3LW (0603)	0.25	±1, ±2, ±5	5 m	0 to +700		
ERJ6LW (0805)	0.5	±1, ±2, ±5	10 m	0 to +300		
ERJ2BW (0402)	0.25	±1, ±2, ±5	47 m to 100 m (E24)	0 to +300		
ERJ3BW (0603)	0.33	±1, ±2, ±5	20 m to 100 m (E24)	20 mΩ ≤ R < 39 mΩ : 0 to +250 39 mΩ ≤ R ≤ 100 mΩ : 0 to +150	-55 to +155	Grade 0
ERJ6BW (0805)	0.5	±1, ±2, ±5	10 m to 100 m (E24)	10 mΩ ≤ R < 15 mΩ : 0 to +300 15 mΩ ≤ R ≤ 100 mΩ : 0 to +200		
ERJ8BW (1206)	1	±1, ±2, ±5	10 m to 100 m (E24)	10 mΩ ≤ R < 20 mΩ : 0 to +200 20 mΩ ≤ R < 47 mΩ : 0 to +150 47 mΩ ≤ R ≤ 100 mΩ : 0 to +100		
ERJ6CW (0805)	0.5	±0.5, ±1, ±2, ±5	10 m to 30 m (E24)	±75	-55 to +125	Grade 1
ERJ8CW (1206)	1	±1, ±2, ±5	10 m to 50 m (E24)	±75		

\*1: Use it on the condition that the case temperature is below the upper category temperature.

\*2: Please contact us when resistors of irregular series are needed.

• Rated Continuous Working Voltage (RCWV) shall be determined from  $RCWV = \sqrt{\text{Power Rating} \times \text{Resistance Value}}$ .

• Overload Test Voltage (OTV) shall be determined from  $OTV = \text{Specified Magnification (refer to performance)} \times RCW$ .

## Thick Film Chip Resistors (Low Resistance Type)

### Ratings

#### <High power type>

Part No. (inch size)	Power rating (70 °C) <sup>*1</sup> (W)	Resistance tolerance (%)	Resistance range <sup>*3</sup> (Ω)	T.C.R. (×10 <sup>-6</sup> /K)	Category temperature range(°C)	AEC-Q200 Grade
ERJ2BS (0402)	0.166	±1, ±2, ±5	0.10 to 0.20 (E24)	0.10 Ω ≤ R < 0.22 Ω : 0 to +300	-55 to +155	Grade 0
ERJ2BQ (0402)			0.22 to 1.0 (E24)	0.22 Ω ≤ R ≤ 1.0 Ω : 0 to +250		
ERJ3BS (0603)	0.25	±1, ±2, ±5	0.10 to 0.20 (E24)	0.10 Ω ≤ R < 0.22 Ω : 0 to +300		
ERJ3BQ (0603)			0.22 to 0.91 (E24)	0.22 Ω ≤ R < 1.0 Ω : 0 to +300		
			1.0 to 9.1 (E24)	1.0 Ω ≤ R ≤ 9.1 Ω : ±200		
ERJ6DS (0805)	0.5	±0.5, ±1, ±2, ±5	0.10 to 0.20 (E24 <sup>*2</sup> )	0.10 Ω ≤ R < 0.22 Ω : 0 to +150		
ERJ6DQ (0805)			0.22 to 9.1 (E24 <sup>*2</sup> )	0.22 Ω ≤ R < 1.0 Ω : 0 to +100 1.0 Ω ≤ R ≤ 9.1 Ω : ±100		
ERJ6BS (0805)	0.33	±1, ±2, ±5	0.10 to 0.20 (E24)	0.10 Ω ≤ R < 0.22 Ω : 0 to +250		
ERJ6BQ (0805)			0.22 to 0.91 (E24)	0.22 Ω ≤ R < 1.0 Ω : 0 to +250		
			1.0 to 9.1 (E24)	1.0 Ω ≤ R ≤ 9.1 Ω : ±200		
ERJ8BS (1206)	0.5	±1, ±2, ±5	0.10 to 0.20 (E24)	0.10 Ω ≤ R < 0.22 Ω : 0 to +250		
ERJ8BQ (1206)			0.22 to 0.91 (E24)	0.22 Ω ≤ R < 1.0 Ω : 0 to +250		
			1.0 to 9.1 (E24)	1.0 Ω ≤ R ≤ 9.1 Ω : ±200		
ERJ14BS (1210)	0.5	±1, ±2, ±5	0.10 to 0.20 (E24)	0.10 Ω ≤ R < 0.22 Ω : 0 to +200		
ERJ14BQ (1210)			0.22 to 0.91 (E24)	0.22 Ω ≤ R < 1.0 Ω : 0 to +200		
			1.0 to 9.1 (E24)	1.0 Ω ≤ R ≤ 9.1 Ω : ±100		

\*1: Use it on the condition that the case temperature is below the upper category temperature.

\*2: E96 series resistance values are also available. Please contact us for details.

\*3: Please contact us when resistors of irregular series are needed.

• Rated Continuous Working Voltage (RCWV) shall be determined from  $RCWV = \sqrt{\text{Power Rating} \times \text{Resistance Value}}$ .

• Overload Test Voltage (OTV) shall be determined from  $OTV = \text{Specified Magnification (refer to performance)} \times RCW$ .

#### <Standard type>

Part No. (inch size)	Power rating (70 °C) <sup>*1</sup> (W)	Resistance tolerance (%)	Resistance range <sup>*2</sup> (Ω)	T.C.R. (×10 <sup>-6</sup> /K)	Category temperature range(°C)	AEC-Q200 Grade
ERJ3RS (0603)	0.1	±1, ±2, ±5	0.10 to 0.20 (E24)	0.10 Ω ≤ R < 0.22 Ω : 0 to +300	-55 to +155	Grade 0
ERJ3RQ (0603)			0.22 to 0.91 (E24)	0.22 Ω ≤ R < 1.0 Ω : 0 to +300		
			1.0 to 9.1 (E24)	1.0 Ω ≤ R ≤ 9.1 Ω : ±200		
ERJ6RS (0805)	0.125	±1, ±2, ±5	0.10 to 0.20 (E24)	0.10 Ω ≤ R < 0.22 Ω : 0 to +250		
ERJ6RQ (0805)			0.22 to 0.91 (E24)	0.22 Ω ≤ R < 1.0 Ω : 0 to +250		
			1.0 to 9.1 (E24)	1.0 Ω ≤ R ≤ 9.1 Ω : ±200		
ERJ8RS (1206)	0.25	±1, ±2, ±5	0.10 to 0.20 (E24)	0.10 Ω ≤ R < 0.22 Ω : 0 to +250		
ERJ8RQ (1206)			0.22 to 0.91 (E24)	0.22 Ω ≤ R < 1.0 Ω : 0 to +250		
			1.0 to 9.1 (E24)	1.0 Ω ≤ R ≤ 9.1 Ω : ±200		
ERJ14RS (1210)	0.25	±1, ±2, ±5	0.10 to 0.20 (E24)	0.10 Ω ≤ R < 0.22 Ω : 0 to +200		
ERJ14RQ (1210)			0.22 to 0.91 (E24)	0.22 Ω ≤ R < 1.0 Ω : 0 to +200		
			1.0 to 9.1 (E24)	1.0 Ω ≤ R ≤ 9.1 Ω : ±100		
ERJ12RS (1812)	0.5	±1, ±2, ±5	0.10 to 0.20 (E24)	0.10 Ω ≤ R < 0.22 Ω : 0 to +200		
ERJ12RQ (1812)			0.22 to 0.91 (E24)	0.22 Ω ≤ R < 1.0 Ω : 0 to +200		
			1.0 to 9.1 (E24)	1.0 Ω ≤ R ≤ 9.1 Ω : ±100		
ERJ12ZS (2010)	0.5	±1, ±2, ±5	0.10 to 0.20 (E24)	0.10 Ω ≤ R < 0.22 Ω : 0 to +200		
ERJ12ZQ (2010)			0.22 to 0.91 (E24)	0.22 Ω ≤ R < 1.0 Ω : 0 to +200		
			1.0 to 9.1 (E24)	1.0 Ω ≤ R ≤ 9.1 Ω : ±100		
ERJ1TRS (2512)	1	±1, ±2, ±5	0.10 to 0.20 (E24)	0.10 Ω ≤ R < 0.22 Ω : 0 to +200		
ERJ1TRQ (2512)			0.22 to 0.91 (E24)	0.22 Ω ≤ R < 1.0 Ω : 0 to +200		
			1.0 to 9.1 (E24)	1.0 Ω ≤ R ≤ 9.1 Ω : ±100		

\*1: Use it on the condition that the case temperature is below the upper category temperature.

\*2: Please contact us when resistors of irregular series are needed.

• Rated Continuous Working Voltage (RCWV) shall be determined from  $RCWV = \sqrt{\text{Power Rating} \times \text{Resistance Value}}$ .

• Overload Test Voltage (OTV) shall be determined from  $OTV = \text{Specified Magnification (refer to performance)} \times RCW$ .

## Thick Film Chip Resistors (Low Resistance Type)

### Ratings

#### <Low TCR type>

Part No. (inch size)	Power rating (70 °C) <sup>*1</sup> (W)	Resistance tolerance (%)	Resistance range <sup>*2</sup> (Ω)	T.C.R. (×10 <sup>-6</sup> /K)	Category temperature range(°C)	AEC-Q200 Grade
ERJL03 (0603)	0.2	±1, ±5	47 m to 100 m	±200	-55 to +125	Grade 1
ERJL06 (0805)	0.25	±1, ±5	47 m to 100 m	±100		
ERJL08 (1206)	0.33	±1, ±5	47 m to 100 m	±100		
ERJL14 (1210)	0.33	±1, ±5	20 m to 100 m	R < 47 mΩ : ±300 R ≥ 47 mΩ : ±100		
ERJL12 (1812)	0.5	±1, ±5	20 m to 100 m			
ERJL1D (2010)	0.5	±1, ±5	40 m to 100 m			

\*1: Use it on the condition that the case temperature is below the upper category temperature.

\*2: Standard R.V. : 20 mΩ, 22 mΩ, 33 mΩ, 39 mΩ, 47 mΩ, 50 mΩ, 100 mΩ, Custom R.V. : Each 1 mΩ within upper range.

- Rated Continuous Working Voltage (RCWV) shall be determined from  $RCWV = \sqrt{\text{Power Rating} \times \text{Resistance Value}}$ .
- Overload Test Voltage (OTV) shall be determined from  $OTV = \text{Specified Magnification (refer to performance)} \times RCW$ .

#### Power derating curve

For resistors operated in ambient temperatures above 70 °C, power rating shall be derated in accordance with the figure on the right.

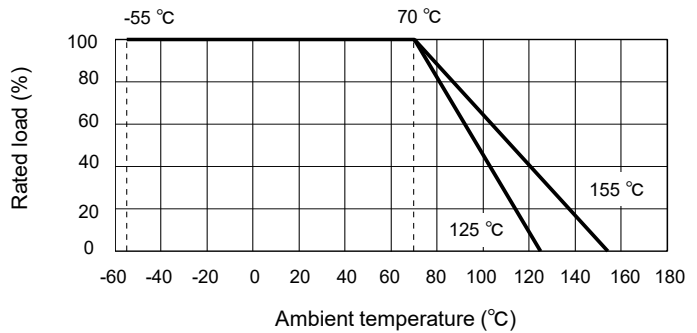

### Construction

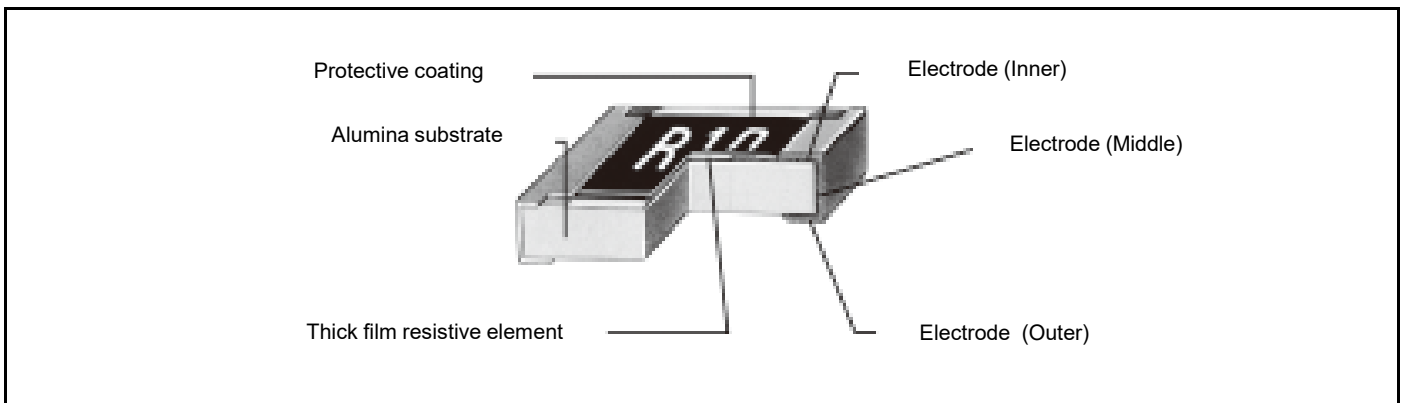

## Thick Film Chip Resistors (Low Resistance Type)

### Dimensions (not to scale)

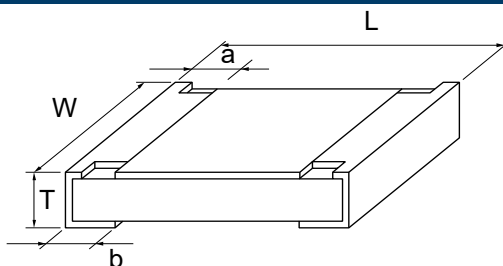

Part No.	Dimensions					Unit : mm
	L	W	a	b	T	Mass (Weight) (Reference) (g/1000 pcs)
ERJ2LW	1.00±0.10	0.50+0.10/-0.05	0.25±0.10	0.25±0.10	0.40±0.05	0.8
ERJ2BW	1.00±0.10	0.50+0.10/-0.05	0.24±0.10	0.24±0.10	0.35±0.05	0.8
ERJ2B	1.00±0.10	0.50+0.10/-0.05	0.20±0.10	0.27±0.10	0.35±0.05	0.8
ERJ3LW (5 mΩ)	1.60±0.15	0.80±0.15	0.50±0.20	0.50±0.20	0.55±0.10	3
ERJ3LW (10 mΩ) ERJ3BW	1.60±0.15	0.80±0.15	0.40±0.20	0.40±0.20	0.55±0.10	3
ERJ3R ERJ3B ERJL03	1.60±0.15	0.80+0.15/-0.05	0.30±0.20	0.30±0.15	0.45±0.10	2
ERJ6LW	2.00±0.20	1.25±0.20	0.63±0.20	0.63±0.20	0.70±0.10	6
ERJ6BW	2.00±0.20	1.25±0.20	0.55±0.20	0.55±0.20	0.65±0.10	6
ERJ6CW (10 to 13 mΩ)	2.05±0.20	1.30±0.20	0.60±0.20	0.60±0.20	0.65±0.10	6
ERJ6CW (15 to 30 mΩ)			0.45±0.20	0.45±0.20		
ERJ6D	2.00±0.20	1.25±0.10	0.40±0.20	0.55±0.25	0.60±0.10	5
ERJ6R ERJ6B ERJL06	2.00±0.20	1.25±0.10	0.40±0.20	0.40±0.20	0.60±0.10	5
ERJ8BW	3.20±0.20	1.60±0.20	1.00±0.20	1.00±0.20	0.65±0.10	13
ERJ8CW (10 to 16 mΩ)	3.20±0.20	1.60±0.20	1.10±0.20	1.10±0.20	0.65±0.10	13
ERJ8CW (18 to 50 mΩ)	3.20±0.20	1.60±0.20	0.60±0.20	0.60±0.20	0.65±0.10	13
ERJ8R ERJ8B ERJL08	3.20+0.05/-0.20	1.60+0.05/-0.15	0.50±0.20	0.50±0.20	0.60±0.10	10
ERJ14R ERJ14B ERJL14	3.20±0.20	2.50±0.20	0.50±0.20	0.50±0.20	0.60±0.10	16
ERJ12R ERJL12	4.50±0.20	3.20±0.20	0.50±0.20	0.50±0.20	0.60±0.10	27
ERJ12Z ERJL1D	5.00±0.20	2.50±0.20	0.60±0.20	0.60±0.20	0.60±0.10	27
ERJ1TR	6.40±0.20	3.20±0.20	0.65±0.20	0.60±0.20	0.60±0.10	45

## Thick Film Chip Resistors (Low Resistance Type)

### Performance

- ERJ2 LW, 3LW, 6LW, 2BW, 3BW, 6BW, 8BW, 6CW, 8CW series  
<High power (double-sided resistive elements structure) type>

Test item	Performance requirements $\Delta R$	Test conditions
Resistance	Within specified tolerance	20 °C
T. C. R.	Within specified T. C. R.	+25 °C / +125 °C
Overload	±2 %	ERJ6LW : Rated voltage× 1.77, 5 s ERJ8BW (R > 0.05 Ω) : Rated voltage× 1.77, 5 s Other : Rated voltage× 2.0, 5 s
Resistance to soldering heat	±1 %	270 °C, 10 s
Rapid change of temperature	±1 % ERJ2LW : ±2 %	-55 °C (30min.) / +155 °C (ERJ□LW, ERJ□CW : +125 °C) (30 min.), 100 cycles
High temperature exposure	±1 %	+155 °C (ERJ□LW, ERJ□CW : +125 °C), 1000 h
Damp Heat, Steady state	±1 %	60 °C, 90 % to 95 %RH, 1000 h
Load life in humidity	±3 %	60 °C, 90 % to 95 %RH, Rated voltage, 1.5 h ON / 0.5 h OFF cycle, 1000 h
Endurance at 70 °C	±3 %	70 °C, Rated voltage, 1.5 h ON / 0.5 h OFF cycle, 1000 h

- ERJ 2BS/Q, 3BS/Q, 6BS/Q, 8BS/Q, 14BS/Q, 6DDS/Q, 3RS/Q, 6RS/Q, 8RS/Q, 14RS/Q, 12RS/Q, 12ZS/Q, 1TRS/Q series <High power type/Standard type>

Test item	Performance requirements $\Delta R$	Test conditions
Resistance	Within specified tolerance	20 °C
T. C. R.	Within specified T. C. R.	+25 °C / +125 °C
Overload	±2 %	Rated voltage× 2.5 (ERJ6D : ×1.77), 5 s
Resistance to soldering heat	±1 %	270 °C, 10 s
Rapid change of temperature	±1 %	-55 °C (30 min.) / +155 °C (30 min.), 100 cycles
High temperature exposure	±1 %	+155 °C, 1000 h
Damp Heat, Steady state	±1 %	60 °C, 90 % to 95 %RH, 1000 h
Load life in humidity	±3 %	60 °C, 90 % to 95 %RH, Rated voltage, 1.5 h ON / 0.5 h OFF cycle, 1000 h
Endurance at 70 °C	±3 %	70 °C, Rated voltage, 1.5 h ON / 0.5 h OFF cycle, 1000 h

- ERJ L03, L06, L08, L14, L12, L1D series < Low TCR type >

Test item	Performance requirements $\Delta R$	Test conditions
Resistance	Within specified tolerance	20 °C
T. C. R.	Within specified T. C. R.	+25 °C / +125 °C
Overload	±2 %	Rated voltage× 2.5, 5 s
Resistance to soldering heat	±1 %	270 °C, 10 s
Rapid change of temperature	±1 %	-55 °C (30 min.) / +125 °C (30 min.), 100 cycles
High temperature exposure	±1 %	+125 °C, 1000 h
Damp Heat, Steady state	±1 %	60 °C, 90 % to 95 %RH, 1000 h
Load life in humidity	±3 %	60 °C, 90 % to 95 %RH, Rated voltage, 1.5 h ON / 0.5 h OFF cycle, 1000 h
Endurance at 70 °C	±3 %	70 °C, Rated voltage, 1.5 h ON / 0.5 h OFF cycle, 1000 h

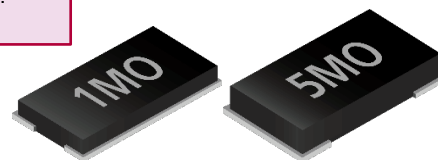

## Current Sensing Resistors, Metal Plate Type

ERJ MS, MB type

**ERJ MS4, MB1** series

### Features

- Ideal for current sensing solution
- Small case size with high power
- Metal plate bonding technology. Excellent long term stability
- Outer Resin with high heat dissipation. Wide temperature range (-65 °C to +170 °C)
- AEC-Q200 compliant
- RoHS compliant
- ISO9001, ISO/TS16949 certified

■ As for packaging methods, land pattern, soldering conditions and safety precautions, please see data files.

### Explanation of part numbers

Note : Please check the "Ratings" for the presence/absence of part numbers for combinations of the symbols below.

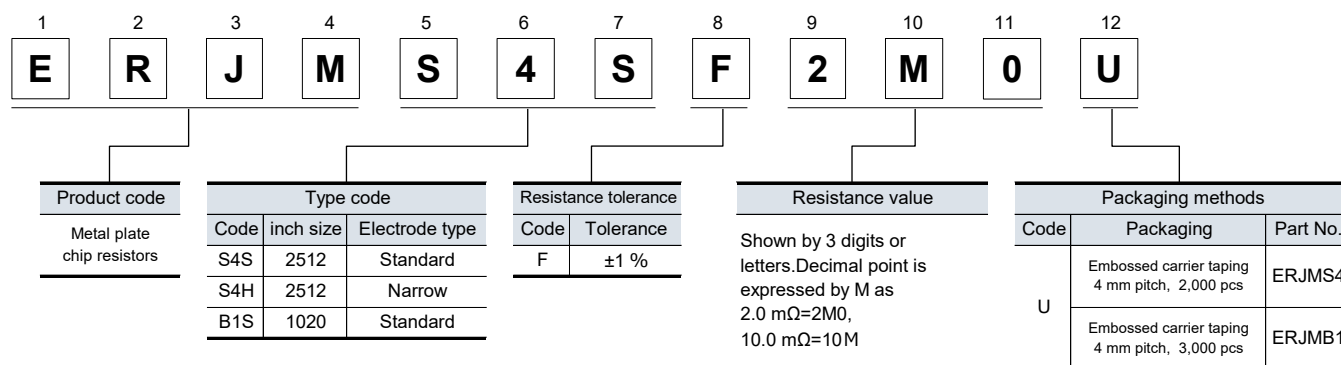

### Ratings

Part No. (inch size)	Power rating (70 °C) (W)	Resistance range (mΩ)	Resistance tolerance (%)	T.C.R. (×10 <sup>-6</sup> /K)	Category temperature range (°C)	Terminal temp. upper limit (°C)	AEC-Q200 Grade
ERJMS4S (2512)	3	1, 2, 3, 4	F : ±1	±75	-65 to +170	130	Grade 0
ERJMS4H (2512)	3	5, 6	F : ±1	±75		100	
ERJMB1S (1020)	2	7, 8, 9, 10	F : ±1	±75		130	

\* Please contact us when resistors of irregular series are needed.

### Power derating curve

If the terminal temperature of the resistor is more than terminal temperature upper limit value of the rated table, please reduce the rated power according to the Power Derating Curve shown in the figure on the right.

<Supplemented>

In the case of the temperature measurement of the terminal portion of the resistor, Please perform under the following conditions.

- 1) Terminal temperature measurement, please apply the temperature of the higher of either the left or right electrode upper surface of the resistor.
- 2) Please measure the temperature of the resistor in the land pattern printed of circuit board and plan to use by real conditions.

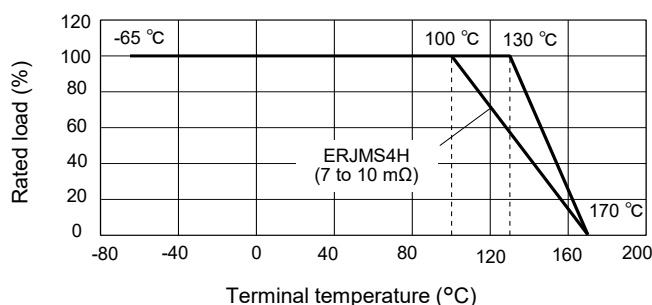

# Current Sensing Resistors, Metal Plate Type

## Construction

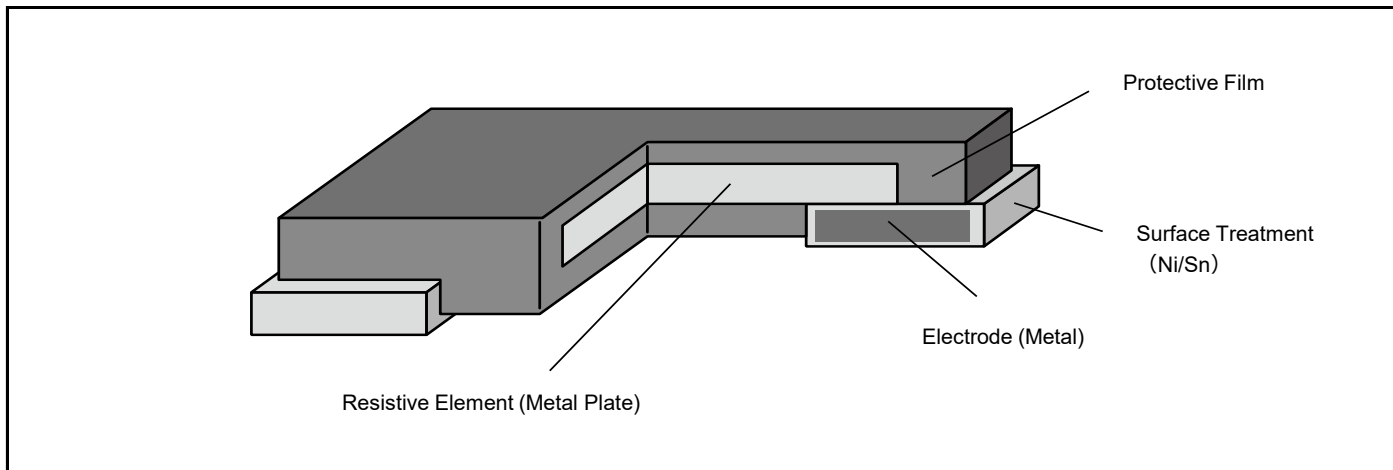

## Dimensions in mm (not to scale), Recommended land pattern

### ● ERJMS4S/ERJMS4H

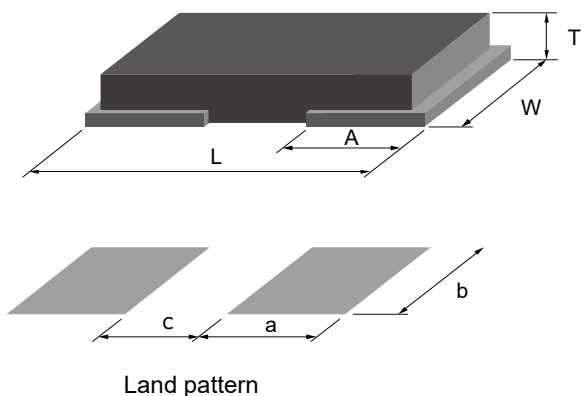

### ● ERJMB1S

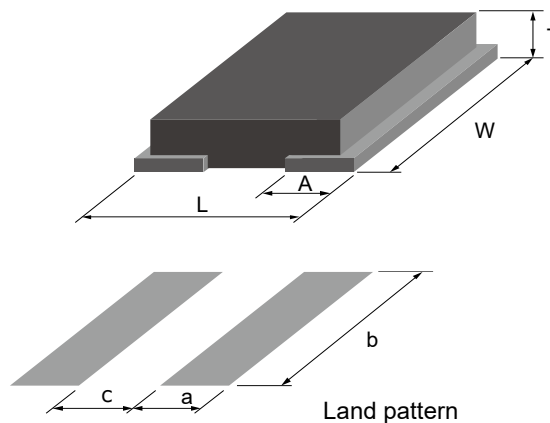

Unit : mm

Part No.	Dimensions				Recommended land pattern			Mass (Weight) (Reference) (g/1000 pcs)
	L	W	A	T	a	b	c	
ERJMS4S	6.40±0.25	3.20±0.25	2.20±0.25	1.20±0.15	2.7	3.4	2.0	120
ERJMS4H	6.40±0.25	3.20±0.25	1.25±0.25	1.20±0.15	1.7	3.4	4.0	115
ERJMB1S	2.55±0.25	5.00±0.25	0.68 +0.15/-0.20	0.90±0.15	1.15	5.5	1.1	40

## Typical temp. dependence of electrical resistance

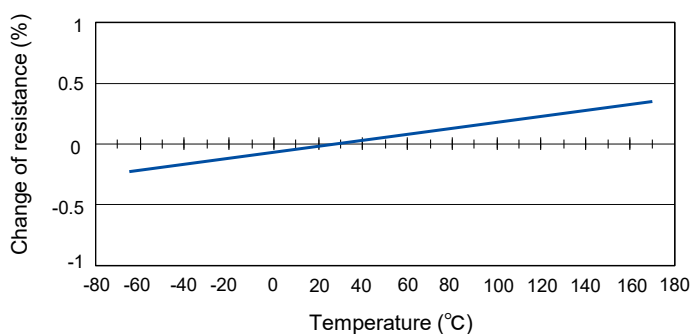

## Long-term stability

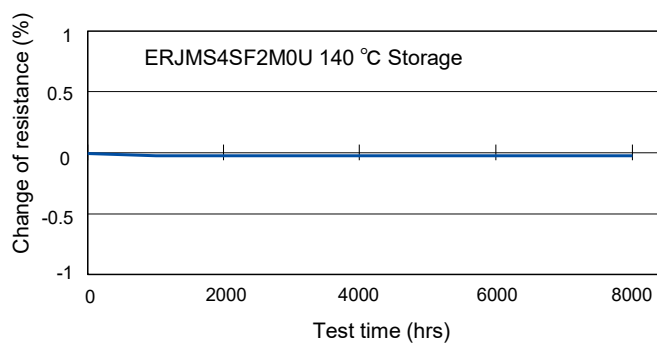

**Maximum pulse energy respectively pulse power for continuous operation**

Reference Data  
 Condition : Room Temperature, OFF : 10 s, 1000 cycle, Wave form : Square  
 Change of Resistance =  $\pm 1\%$

● ERJMS4S/ERJMS4H

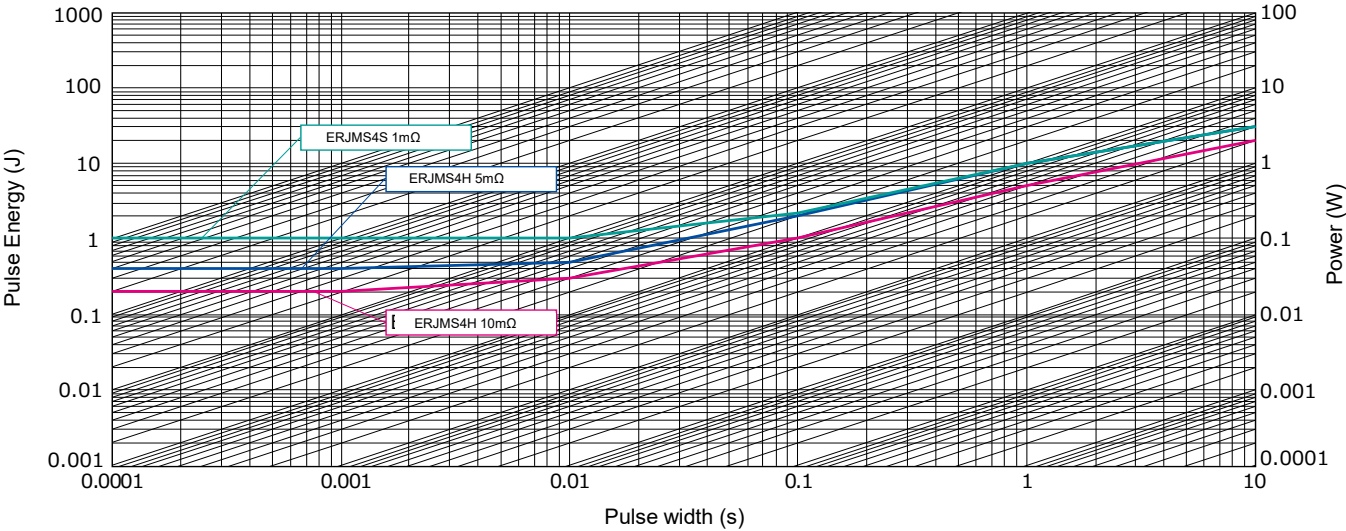

● ERJMB1S

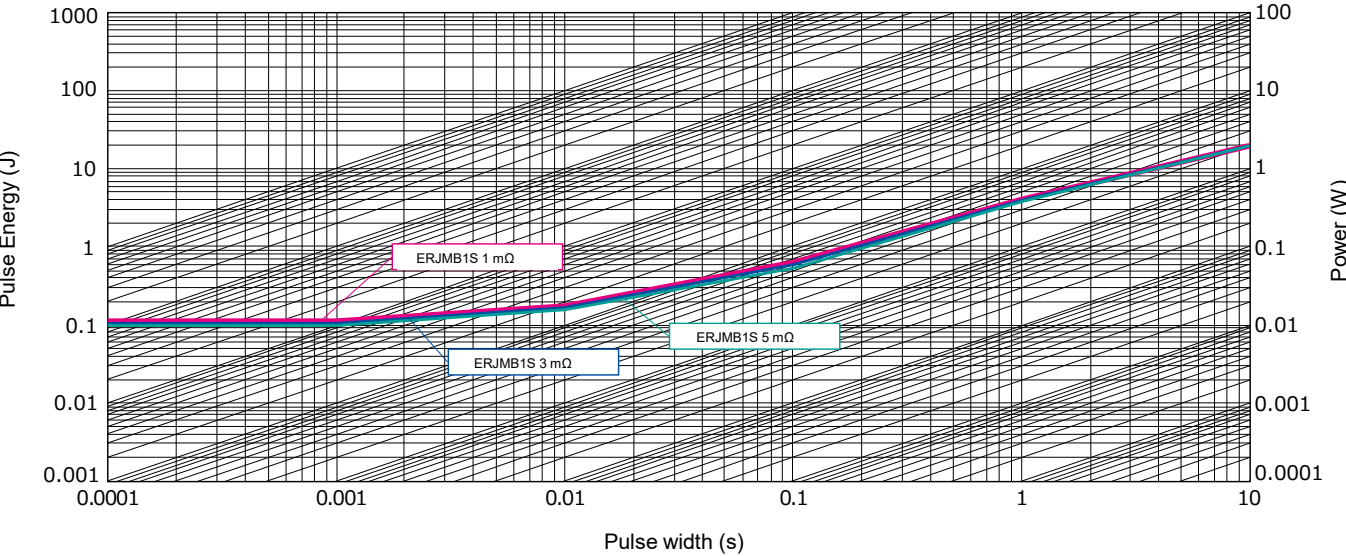



### Performance (AEC-Q200)

#### ● ERJMS4S/ERJMS4H

Test item	Performance requirements $\Delta R$	Typical value $\Delta R$	Test condition
Thermal shock	$\pm 1\%$	0.20 %	-55 °C / +155 °C, 1000 cycles
Overload	$\pm 0.5\%$	0.10 %	Rated power x 3, 5 s
Solderability	> 95% coverage	> 95% coverage	245 °C, 3 s
Resistance to solvents	No damage	No damage	MIL-STD-202 method 215, 2.1a, 2.1d
Low temperature storage and operation	$\pm 0.5\%$	0.03 %	-65 °C, 24 h
Resistance to soldering heat	$\pm 0.5\%$	0.10 %	MIL-STD-202 method 210 (260 °C, 10 s)
Moisture resistance	$\pm 0.5\%$	0.10 %	MIL-STD-202 method 106
Shock	$\pm 0.5\%$	0.10 %	MIL-STD-202 method 213-A
Vibration, High frequency	$\pm 0.5\%$	0.05 %	10 to 2000 (Hz)
Life	$\pm 1\%$	0.30 %	70 °C, Rated Power, 2000 h
Storage life at elevated temperature	$\pm 1\%$	0.30 %	170 °C, 2000 h
High temperature characteristics	$\pm 0.5\%$	0.05 %	140 °C, 2000 h
Frequency characteristics	< 5 nH	< 2 nH	Inductance

#### ● ERJMB1

Test item	Performance requirements $\Delta R$	Typical value $\Delta R$	Test condition
Thermal shock	$\pm 1\%$	0.30 %	-55 °C / +155 °C, 1000 cycles
Overload	$\pm 1\%$	0.30 %	Rated power x 2.5, 5 s
Solderability	> 95% coverage	> 95% coverage	245 °C, 3 s
Resistance to solvents	No damage	No damage	MIL-STD-202 method 215, 2.1a, 2.1d
Low temperature storage and operation	$\pm 0.5\%$	0.03 %	-65 °C, 24 h
Resistance to soldering heat	$\pm 0.5\%$	0.10 %	MIL-STD-202 method 210 (260 °C, 10 s)
Moisture resistance	$\pm 0.5\%$	0.10 %	MIL-STD-202 method 106
Shock	$\pm 0.5\%$	0.10 %	MIL-STD-202 method 213-A
Vibration, High frequency	$\pm 0.5\%$	0.05 %	10 to 2000 (Hz)
Life	$\pm 1\%$	0.30 %	70 °C, Rated Power, 2000 h
Storage life at elevated temperature	$\pm 1\%$	0.30 %	170 °C, 2000 h
High temperature characteristics	$\pm 0.5\%$	0.05 %	140 °C, 2000 h
Frequency characteristics	< 5 nH	< 2 nH	Inductance

### Temperature rise

#### ● ERJMS4HF5M0U

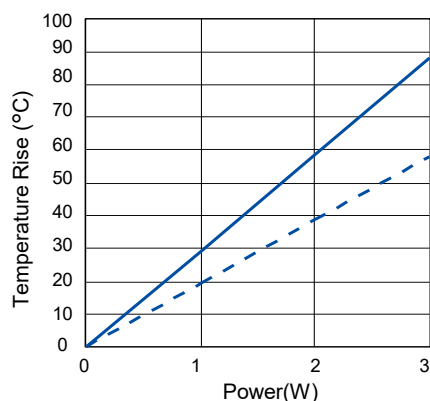

#### ● ERJMB1SF3M0U

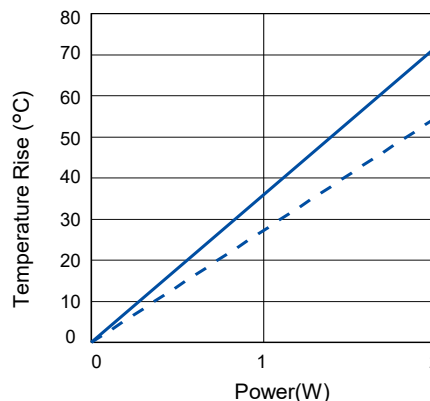

- ① ———— <Condition>  
 ② - - - - Base material : FR-4 (t 1.6 mm)  
 Copper Thickness : 70  $\mu$ m, Two layer

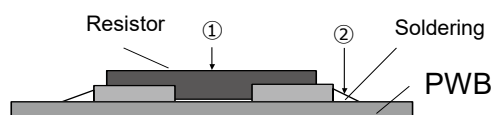

### Sense terminal-Layout

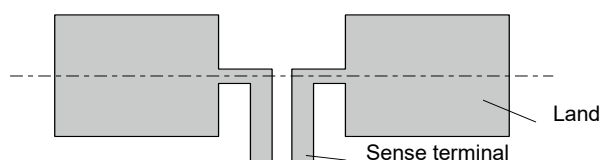



## High Power Chip Resistors (Wide Terminal Type)

ERJ A, B type

ERJ A1, B1, B2, B3 series

### Features

- High solder-joint reliability by wide terminal construction
- Excellent heat dissipation characteristics by wide terminal construction
- AEC-Q200 compliant
- RoHS compliant

### Recommended applications

- Automotive electronic circuits including ECUs (Electrical control unit), anti-lock breaking systems and air-bag systems.
- Current sensing for power supply circuits in a variety of equipment.

■ As for packaging methods, land pattern, soldering conditions and safety precautions, please see data files.

### Explanation of part numbers

Note : Please check the "Ratings" for the presence/absence of part numbers for combinations of the symbols below.

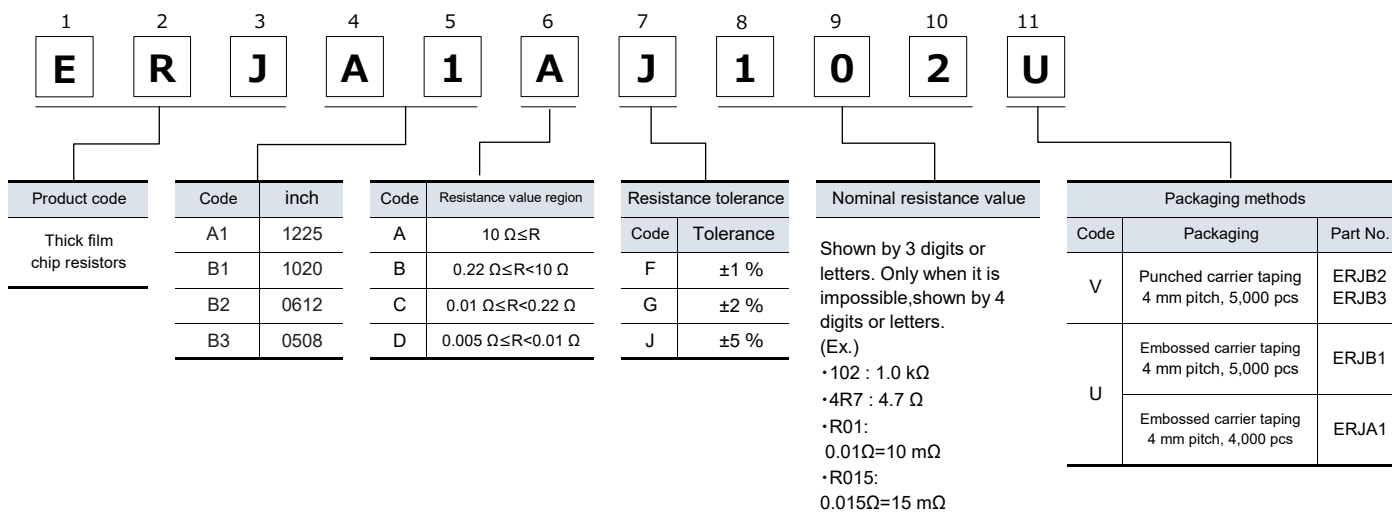

## High Power Chip Resistors (Wide Terminal Type)

### Ratings

Part No. (inch size)	Power rating <sup>*1</sup> (W)	Rated ambient temperature <sup>*2</sup> (°C)	Rated terminal part temperature <sup>*2</sup> (°C)	Limiting element voltage <sup>*3</sup> (V)	Maximum overload voltage <sup>*4</sup> (V)	Resistance tolerance (%)	Resistance range (Ω)	T.C.R. (×10 <sup>-6</sup> /K)	Category temperature range (°C)	AEC-Q200 Grade
ERJA1 (1225)	1.33	70	-	200	400	±1	100m to 10k (E24)	±100		
						±2, ±5	10m to 10k (E24)	10mΩ≤R<100mΩ : ±350 100mΩ≤R≤10kΩ : ±200		
ERJB1 (1020)	2 (R≤10Ω)	70	125	200	400	±1	10m to 10 (E24)	±1 % : 10mΩ≤R<22mΩ : 0 to +350 22mΩ≤R<47mΩ : 0 to +200 47mΩ≤R<100mΩ : 0 to +150 100mΩ≤R≤10kΩ : ±100	-55 ~ +155	Grade 0
						±2, ±5				
	1 (R>10Ω)	70	95			±1	11 to 10k (E24)	±2 %, ±5 % : 10mΩ≤R<22mΩ : 0 to +350 22mΩ≤R<100mΩ : 0 to +200 100mΩ≤R≤10kΩ : ±200		
						±2, ±5				
ERJB2 (0612)	1.5 (R≤1kΩ)	-	125	200	400	±1	10m to 1k (E24)	±1 % : 10mΩ≤R<22mΩ : 0 to +300 22mΩ≤R<47mΩ : 0 to +200 47mΩ≤R<100mΩ : 0 to +150 100mΩ≤R≤220mΩ : 0 to +100 220mΩ≤R≤1MΩ : ±100 ±2 %, ±5 % : 5mΩ≤R<22mΩ : 0 to +300 22mΩ≤R<47mΩ : 0 to +200 47mΩ≤R<100mΩ : 0 to +150 100mΩ≤R<220mΩ : 0 to +200 220mΩ≤R≤1MΩ : ±200		
	0.75 (R>1kΩ)	-	90			±1				
	1 (R≤10Ω)	70	-			±1	10m to 10 (E24)			
						±2				
	0.75 (R>10Ω)	70				±1	11 to 1M (E24)			
						±2, ±5				
ERJB3 (0508)	1	-	105	150	200	±1	20m to 10 (E24)	±1 % : 20mΩ≤R<47mΩ : 0 to +300 47mΩ≤R<1Ω : 0 to +200 1Ω≤R≤10Ω : ±100 ±2 %, ±5 % : 20mΩ≤R<47mΩ : 0 to +300 47mΩ≤R<1Ω : 0 to +200 1Ω≤R≤10Ω : ±200		
						±2, ±5				
	0.5 (R≤1Ω)	70	-			±1	20m to 1 (E24)			
						±2, ±5				
0.33 (R>1Ω)	70	-	±1	1.1 to 10 (E24)						
			±2, ±5							

\*1: Use it on the condition that the case temperature is below the upper category temperature.

\*2: If there is a doubt whether the rated ambient temperature or the rated terminal part temperature is used, give priority to the rated terminal part temperature.

\*3: Rated Continuous Working Voltage (RCWV) shall be determined from  $RCWV = \sqrt{\text{Power Rating} \times \text{Resistance Value}}$ , or Limiting Element Voltage listed above, whichever less.

\*4: Overload Test Voltage (OTV) shall be determined from  $OTV = \text{Specified Magnification (refer to performance)} \times RCWV$  or Maximum Overload Voltage listed above, whichever less.

## Ratings

### Power derating curve

- For resistors operated in ambient rated ambient temperature, power rating shall be derated in accordance with the figure below.  
In addition, please use under the condition that the product temperature is below the upper category temperature.

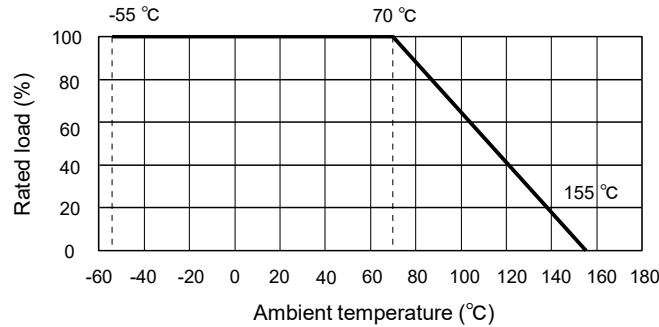

- For resistors operated in ambient rated terminal part temperature, power rating shall be derated in accordance with the figure below.  
In addition, please use under the condition that the product temperature is below the upper category temperature.

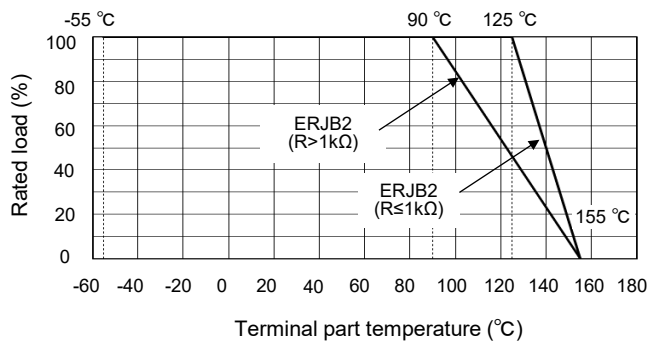
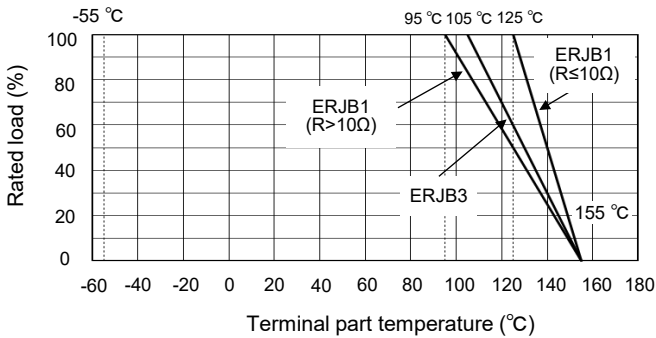

## Construction (Example : ERJA1 type)

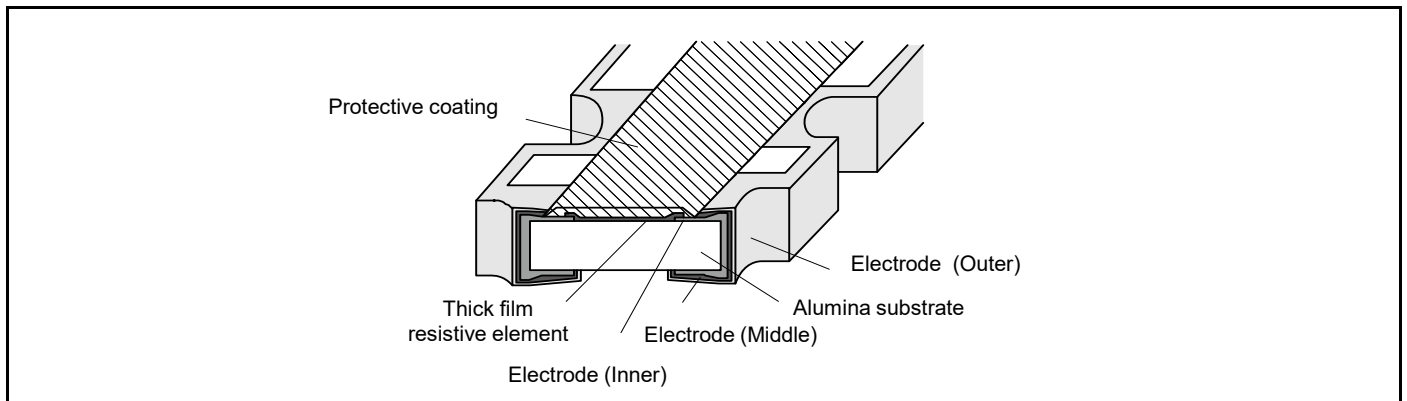

## High Power Chip Resistors (Wide Terminal Type)

### Dimensions (not to scale)

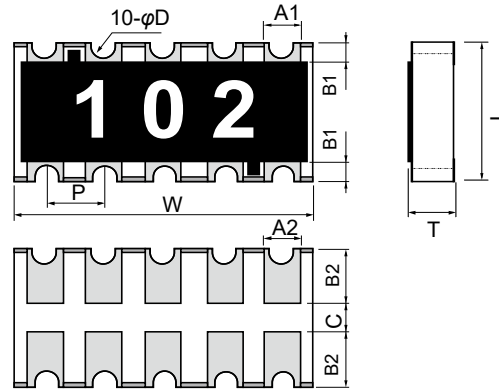

Part No.	Dimensions					Mass (Weight) (Reference) (g/1000 pcs)
	L	W	A <sub>1</sub>	B <sub>1</sub>	T	40
ERJA1	3.20±0.20	6.40±0.20	0.70±0.20	0.45±0.20	0.55±0.10	
	A <sub>2</sub>	B <sub>2</sub>	P	φD	C	
	0.70±0.20	1.25±0.15	1.27±0.10	0.30+0.10/-0.20	0.4 min.	

Unit : mm

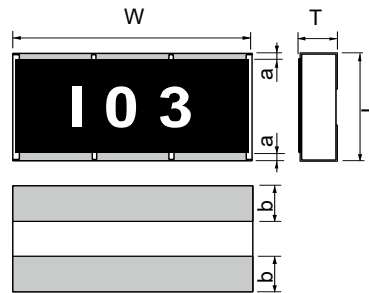

Part No.	Dimensions					Mass (Weight) (Reference) (g/1000 pcs)
	L	W	a	b	T	27
ERJB1	2.50±0.20	5.00±0.20	0.25±0.20	0.90±0.20	0.55±0.20	

Unit : mm

( R < 10 mΩ )

( 10 mΩ ≤ R ≤ 1 MΩ )

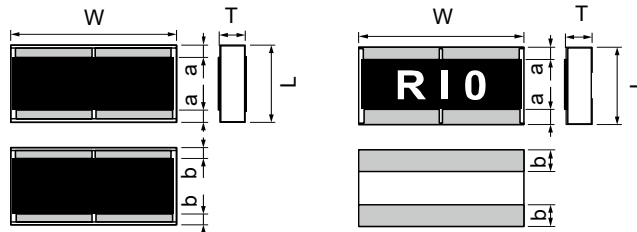

Part No.	Dimensions					Mass (Weight) (Reference) (g/1000 pcs)
	L	W	a	b	T	11
ERJB2						
5 mΩ ≤ R < 10 mΩ	1.60±0.15	3.20±0.20	0.30±0.20	0.30±0.20	0.65±0.15	
10 mΩ ≤ R < 220 mΩ			0.25±0.20	0.50±0.20	0.55±0.15	
220 mΩ ≤ R ≤ 1 MΩ						

Unit : mm

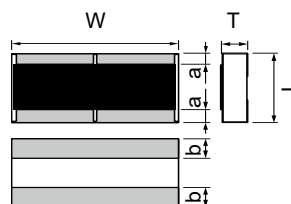

Part No.	Dimensions					Mass (Weight) (Reference) (g/1000 pcs)
	L	W	a	b	T	4.8
ERJB3	1.25±0.10	2.00±0.15	0.25±0.20	0.40±0.20	0.50±0.10	

Unit : mm

## High Power Chip Resistors (Wide Terminal Type)

### Circuit configuration

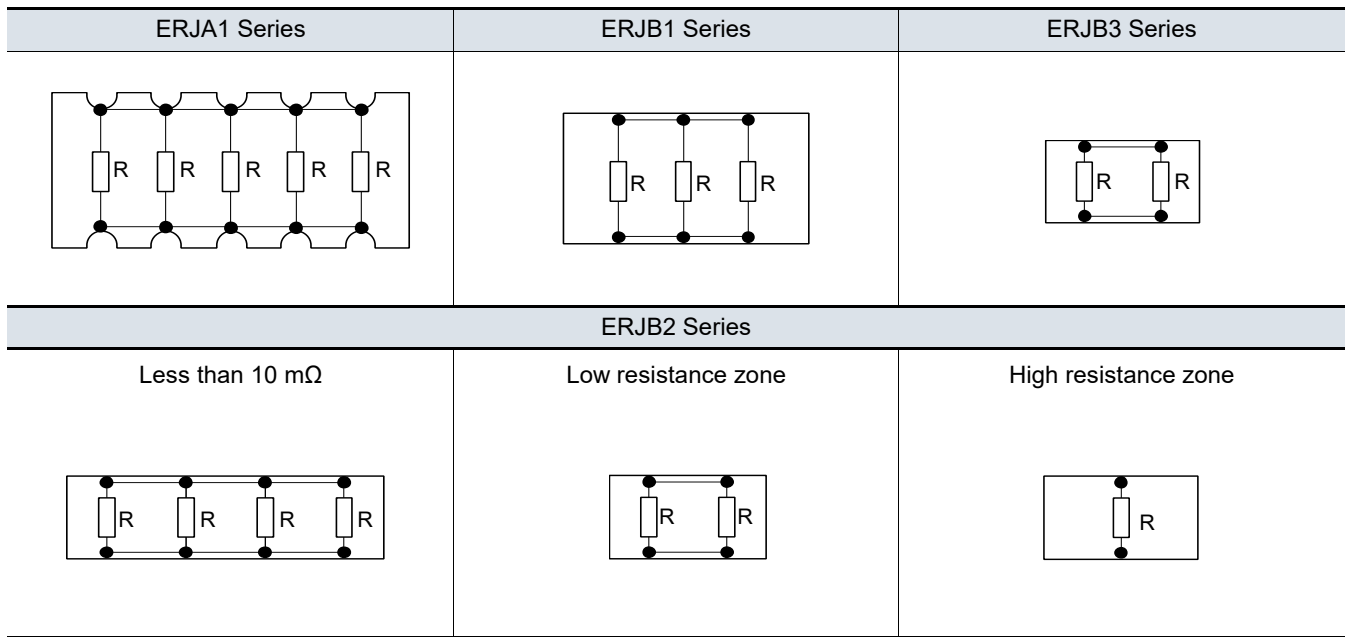

### Performance

Test Item	Performance requirements $\Delta R$	Test conditions
Resistance	Within specified tolerance	20 °C
T. C. R.	Within specified T. C. R.	+25 °C / +125 °C
Overload	$\pm 2$ %	ERJA1, ERJB1 (1W) : Rated voltage x 2.5, 5 s ERJB2 (0.75 W) : Rated voltage x 2.2, 5 s ERJB1 (2 W), ERJB2 (1.5 W, 1 W), ERJB3 : Rated voltage x 2.0, 5 s
Resistance to soldering heat	$\pm 1$ %	270 °C, 10 s
Rapid change of temperature	$\pm 2$ %	-55 °C (30 min.) / +125 °C (30 min.), 1000 cycles
High temperature exposure	$\pm 1$ %	+155 °C, 1000 h
Damp heat, Steady state	$\pm 1$ %	60 °C, 90 % to 95 %RH, 1000 h
Load life in humidity 1 <small>(Applicable to rated ambient temperature-regulated products)</small>	$\pm 3$ %	60 °C, 90 % to 95 %RH, Rated voltage 1.5 h ON / 0.5 h OFF cycle, 1000 h
Load life in humidity 2 <small>(Applicable to rated ambient temperature-regulated products)</small>	$\pm 3$ %	85 °C, 85 %RH, Rated power 10%, Continuously power, 1000 h
Durability at rated ambient temperature or rated terminal part temperature	$\pm 3$ %	Rated ambient temperature or rated terminal part temperature, Rated voltage, 1.5 h ON / 0.5 h OFF cycle, 1000 h

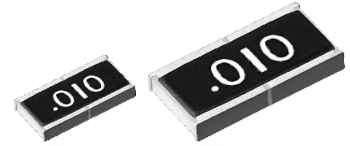

## Low TCR High Power Chip Resistors (Wide Terminal Type)

ERJ D type

ERJ D1, D2 series

### Features

- Achieved High power and low TCR ( $\pm 100 \times 10^{-6}/K$ ) using wide terminal electrode structure and original material
- Suitable for small size/high power current detection (Low TCR enables high accuracy of current detection)
- High solder-joint reliability by wide terminal construction
- Excellent heat dissipation characteristics by wide terminal construction
- AEC-Q200 compliant
- RoHS compliant

### Recommended applications

- Automotive electronic circuits including ECUs (Electrical control unit), anti-lock breaking systems and air-bag systems.
- Current sensing for power supply circuits in a variety of equipment.
  - As for packaging methods, land pattern, soldering conditions and safety precautions, please see data files.

### Explanation of part numbers

Note : Please check the "Ratings" for the presence/absence of part numbers for combinations of the symbols below.

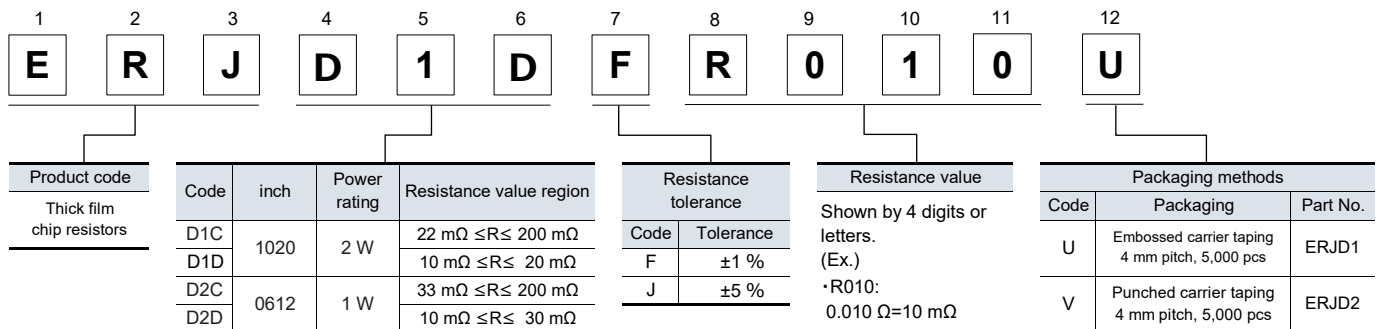

### Ratings

Part No. (inch size)	Power rating (70 °C) <sup>-1</sup> (W)	Resistance tolerance (%)	Resistance range (Ω)	T.C.R. ( $\times 10^{-6}/K$ )	Category temperature range (°C)	AEC-Q200 Grade
ERJD1 (1020)	2	±1, ±5	10 m to 200 m (E24)	±100	-55 to +155	Grade 0
ERJD2 (0612)	1	±1, ±5	10 m to 200 m (E24)	±100		

\*1: Use it on the condition that the case temperature is below the upper category temperature.

- Please contact us when resistors of irregular series are needed.
- Rated Continuous Working Voltage (RCWV) shall be determined from  $RCWV = \sqrt{\text{Power Rating} \times \text{Resistance Value}}$ .
- Overload Test Voltage (OTV) shall be determined from  $OTV = \text{Specified Magnification (refer to performance)} \times RCWV$ .

### Power derating curve

For resistors operated in ambient temperatures above 70 °C, power rating shall be derated in accordance with the figure on the right.

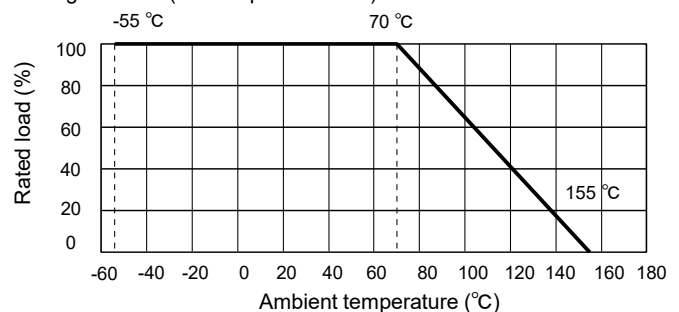

## Low TCR High Power Chip Resistors (Wide Terminal Type)

### Construction

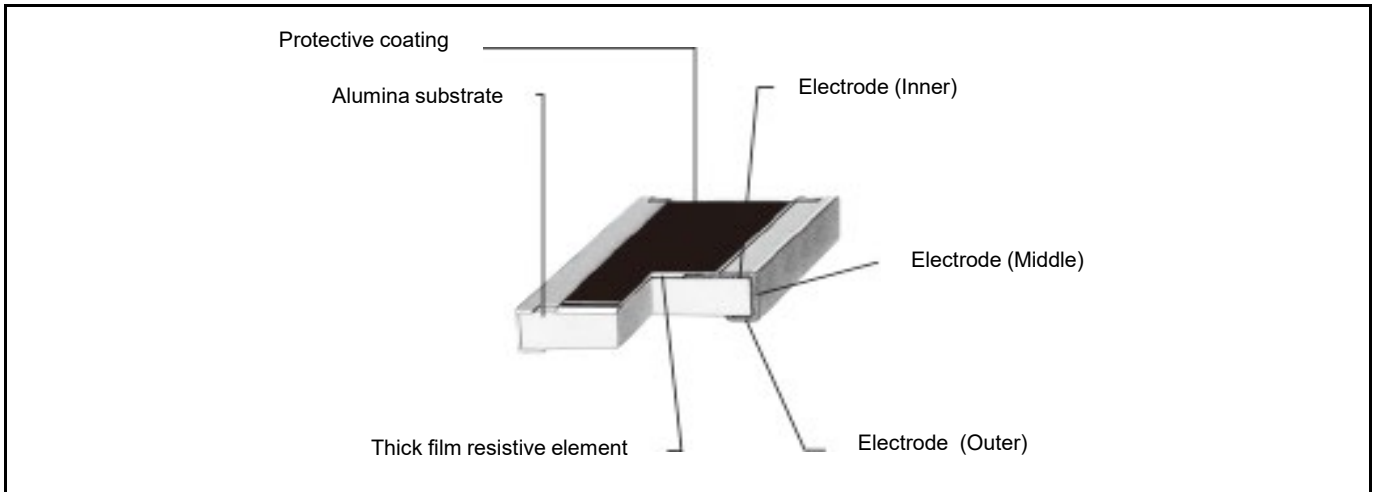

### Dimensions (not to scale)

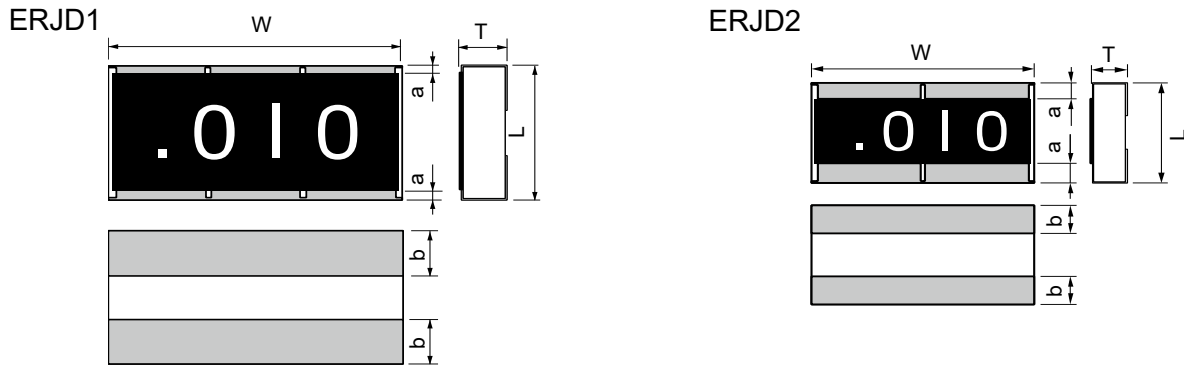

Unit : mm

Part No.	Dimensions					Mass (Weight) (Reference) (g/1000 pcs)
	L	W	a	b	T	
ERJD1	2.50±0.20	5.00±0.20	0.30±0.20	0.90±0.20	0.60±0.20	27
ERJD2	1.60±0.15	3.20±0.20	0.30±0.20	0.50±0.20	0.65±0.15	11

### Circuit configuration

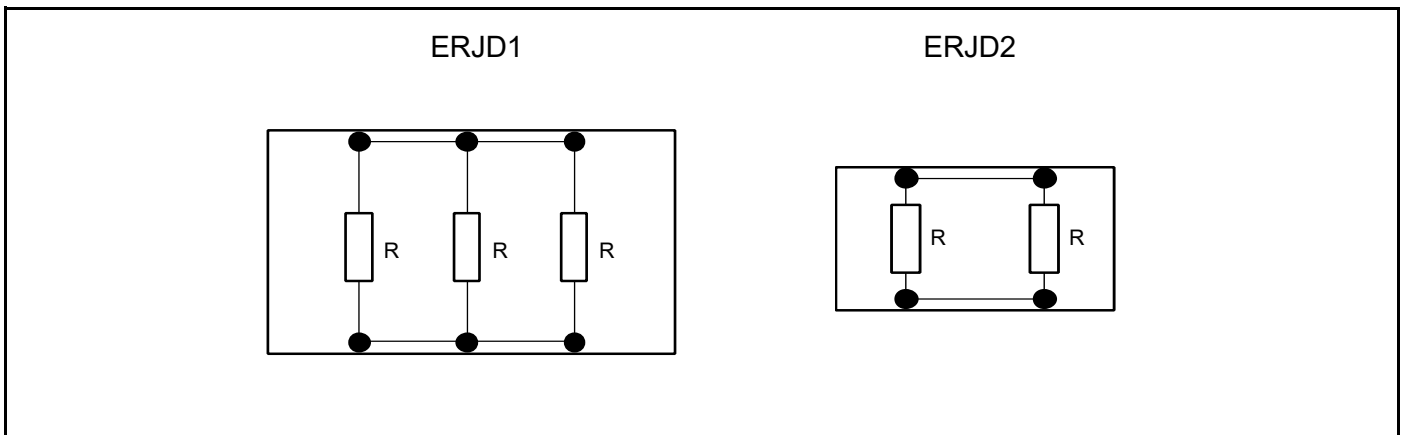



## Low TCR High Power Chip Resistors (Wide Terminal Type)

### Performance

Test Item	Performance requirements $\Delta R$	Test conditions
Resistance	Within specified tolerance	20 °C
T. C. R.	Within specified T. C. R.	+25 °C / +125 °C
Overload	±2 %	Rated voltage x 2.0, 5 s
Resistance to soldering heat	±1 %	270 °C, 10 s
Rapid change of temperature	±2 %	-55 °C (30 min.) / +125 °C (30 min.), 1000 cycles
High temperature exposure	±1 %	+155 °C, 1000 h
Damp heat, Steady state	±1 %	60 °C, 90 % to 95 %RH, 1000 h
Load life in humidity	±3 %	60 °C, 90 % to 95 %RH, Rated voltage, 1.5 h ON / 0.5 h OFF cycle, 1000 h
Endurance at 70 °C	±3 %	70 °C, Rated voltage, 1.5 h ON / 0.5 h OFF cycle, 1000 h

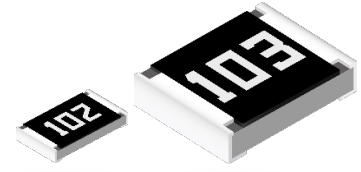

## Anti-Surge Thick Film Chip Resistors

ERJ P, PA,PM type

**ERJ PA2, PA3, P03, P06, P08, PM8, P14** series

### Features

- ESD surge characteristics superior to standard metal film resistors
- High reliability : Metal glaze thick film resistive element and three layers of electrodes
- Suitable for both reflow and flow soldering
- High power
  - 0.20 W : 0603 inch / 1608 mm size (ERJP03)
  - 0.20 W : 0402 inch / 1005 mm size (ERJPA2)
  - 0.33 W : 0603 inch / 1608 mm size (ERJPA3)
  - 0.50 W : 0805 inch / 2012 mm size (ERJP06), 1210 inch / 3225 mm size (ERJP14)
  - 0.66 W : 1206 inch / 3216 mm size (ERJP08)
- High precision, High voltage, High resistance value (ERJPM8)
  - : Limiting element voltage 500 V, Resistance tolerance  $\pm 1\%$ , TCR  $\pm 100$  ( $\times 10^{-6}$  / K)
- Reference standard : IEC 60115-8, JIS C 5201-8, JEITA RC-2134C
- AEC-Q200 compliant
- RoHS compliant

■ As for packaging methods, land pattern, soldering conditions and safety precautions, please see data files.

### Explanation of part numbers

Note : Please check the "Ratings" for the presence/absence of part numbers for combinations of the symbols below.

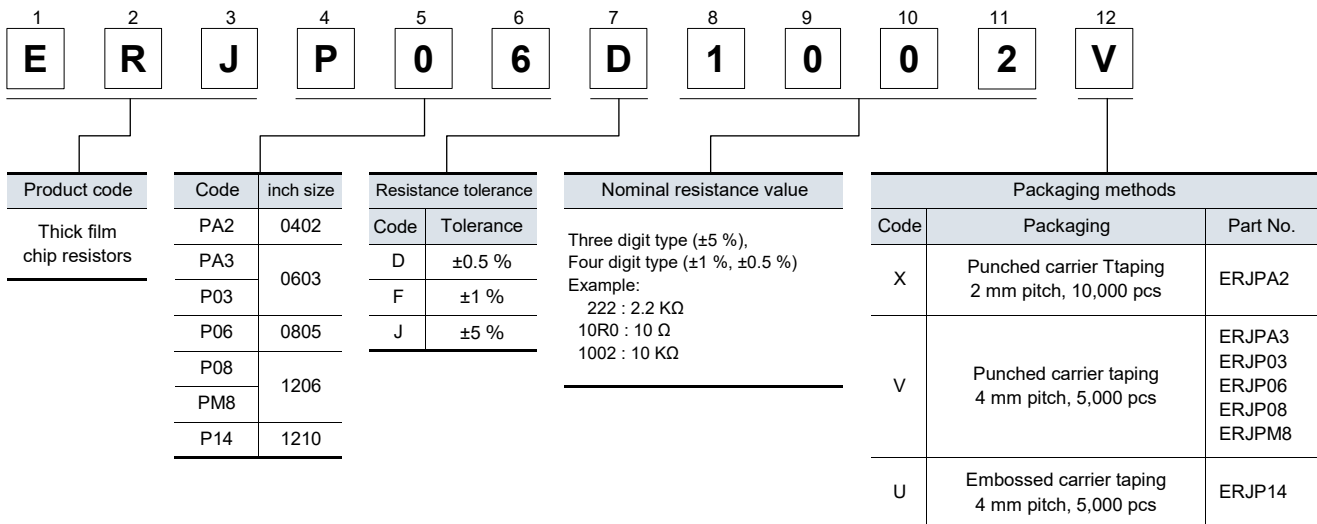

## Anti-Surge Thick Film Chip Resistors

### Ratings

Part No. (inch size)	Power rating <sup>*1</sup> (W)	Rated ambient temperature <sup>*2</sup> (°C)	Rated terminal part temperature <sup>*2</sup> (°C)	Limiting element voltage <sup>*3</sup> (V)	Maximum overload voltage <sup>*4</sup> (V)	Resistance tolerance (%)	Resistance range (Ω)	T.C.R. (×10 <sup>-6</sup> /K)	Category temperature range (°C)	AEC-Q200 Grade
ERJPA2 (0402)	0.20	70	-	50	100	±0.5, ±1	10 to 1M (E24, E96)	±0.5, ±1 : ±100 ±5 : ±200 R<10Ω : -100 to +600		Grade 1
						±5	Resistance value expansion 1 to 1M (E24)			
	0.25	-	100			±0.5, ±1	10 to 1M (E24, E96)			
						±5	Resistance value expansion 1 to 1M (E24)			
ERJPA3 (0603)	0.25	105	-	150	200	±0.5, ±1	10 to 1M (E24, E96)	±0.5, ±1 : ±100 ±5 : ±200		
						±5	1 to 1.5M (E24)			
	0.33	-	130			±0.5, ±1	10 to 1M (E24, E96)			
						±5	1 to 1.5M (E24)			
ERJP03 (0603)	0.20	70	-	150	200	±0.5	10 to 1M (E24, E96)	±150	-55 to +155	
						±1	10 to 1M (E24, E96)	R<10Ω : -150 to +400		
						±5	1 to 1M (E24)	10Ω≤R : ±200		
ERJP06 (0805)	0.50	70	115	400	600	±0.5, ±1	10 to 1M (E24, E96)	R<33Ω : ±300 33Ω≤R : ±100		Grade 0
						±5	1 to 3.3M (E24)	R<10Ω : -100 to +600 10Ω≤R<33Ω : ±300 33Ω≤R : ±200		
ERJP08 (1206)	0.66	70	125	500	1000	±0.5, ±1	10 to 1M (E24, E96)	±100		
						±5	1 to 10M (E24)	R<10Ω : -100 to +600 10Ω≤R : ±200		
ERJPM8 (1206)	0.66	70	125	500	1000	±1	1.02M to 10M (E24, E96)	±100		
ERJP14 (1210)	0.50	70	-	200	400	±0.5, ±1	10 to 1M (E24, E96)	±100		
						±5	1 to 1M (E24)	R<10Ω : -100 to +600 10Ω≤R : ±200		

\*1: Use it on the condition that the case temperature is below the upper category temperature.

\*2: If there is a doubt whether the rated ambient temperature or the rated terminal part temperature is used, give priority to the rated terminal part temperature.

\*3: Rated Continuous Working Voltage (RCWV) shall be determined from  $RCWV = \sqrt{\text{Power Rating} \times \text{Resistance Value}}$ , or Limiting Element Voltage listed above, whichever less.

\*4: Overload Test Voltage (OTV) shall be determined from  $OTV = \text{Specified Magnification (refer to performance)} \times RCWV$  or Maximum Overload Voltage listed above, whichever less.

## Ratings

### Power derating curve

- For resistors operated in ambient rated ambient temperature, power rating shall be derated in accordance with the figure below.

In addition, please use under the condition that the product temperature is below the upper category temperature.

※ When the temperature of ERJP14 is 155 °C or less, the derating start temperature can be changed to 125 °C. (See the dotted line)

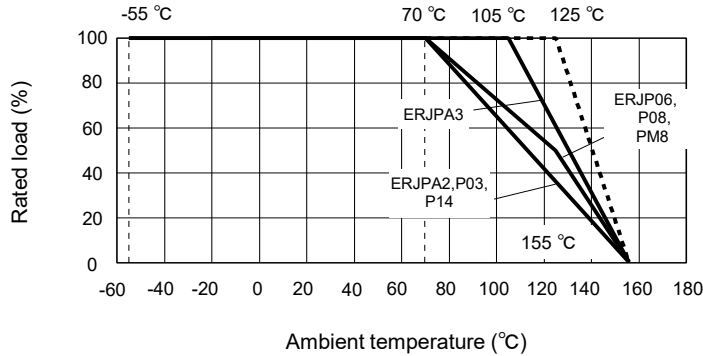

- For resistors operated in ambient rated terminal part temperature, power rating shall be derated in accordance with the figure below.

In addition, please use under the condition that the product temperature is below the upper category temperature.

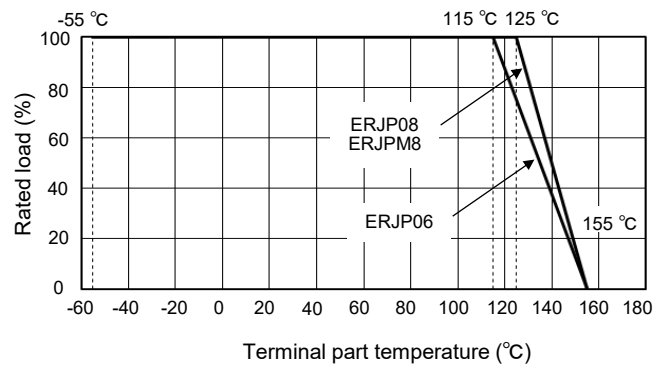
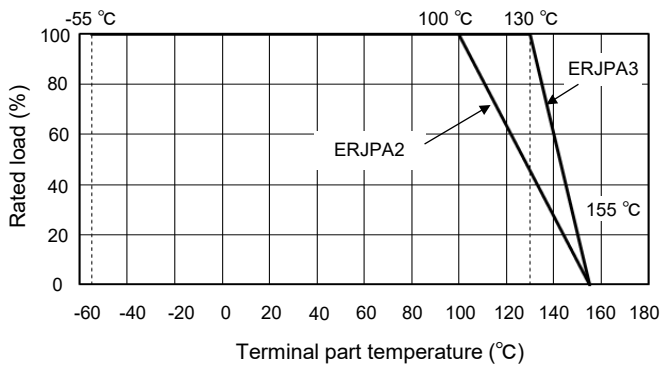

## Construction

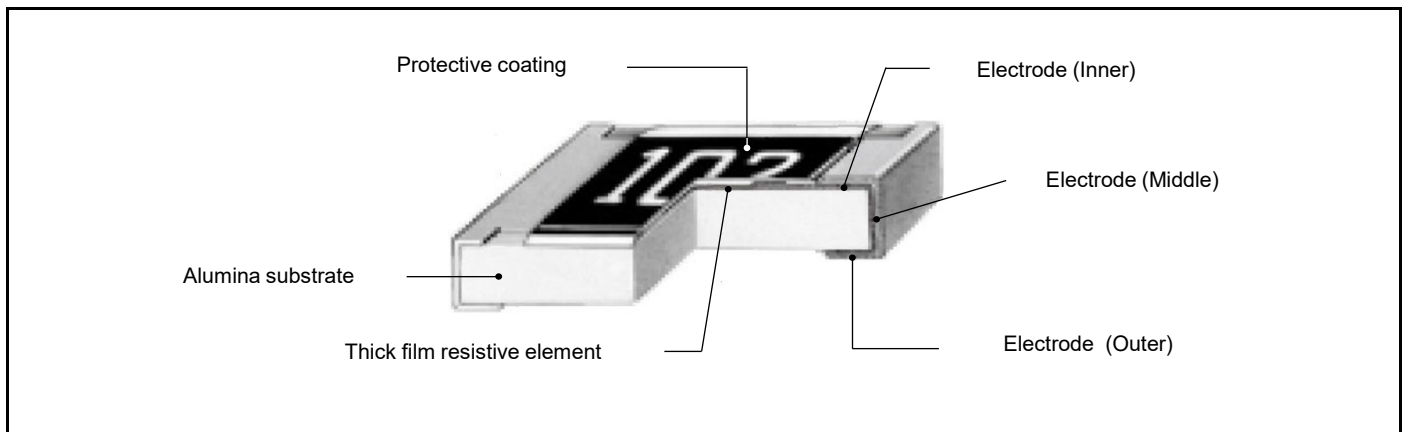

## Dimensions (not to scale)

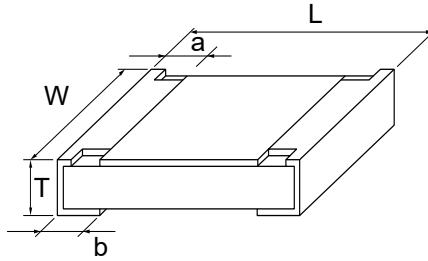

Unit : mm

Part No.	Dimensions					Mass (Weight) (Reference) (g/1000 pcs)
	L	W	a	b	T	
ERJPA2	1.00±0.05	0.50±0.05	0.20±0.15	0.25±0.10	0.35±0.05	0.8
ERJPA3	1.60±0.15	0.80+0.15/-0.05	0.15+0.15/-0.10	0.25±0.10	0.45±0.10	2
ERJP03	1.60±0.15	0.80+0.15/-0.05	0.15+0.15/-0.10	0.30±0.15	0.45±0.10	2
ERJP06	2.00±0.20	1.25±0.10	0.25±0.20	0.40±0.20	0.60±0.10	4
ERJP08,PM8	3.20+0.05/-0.20	1.60+0.05/-0.15	0.40±0.20	0.50±0.20	0.60±0.10	10
ERJP14	3.20±0.20	2.50±0.20	0.35±0.20	0.50±0.20	0.60±0.10	16

## ESD Characteristic

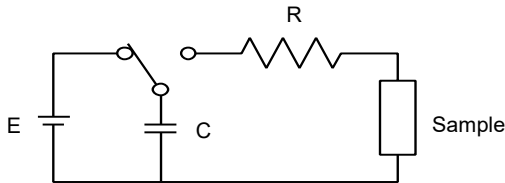

Size (inch)	0402	0603, 0805, 1206, 1210
R	1.5 kΩ	R=0 Ω (≤1.5 kΩ) / 150 Ω (>1.5 kΩ)
C	100 pF	150 pF
E	±1 kV	±3 kV

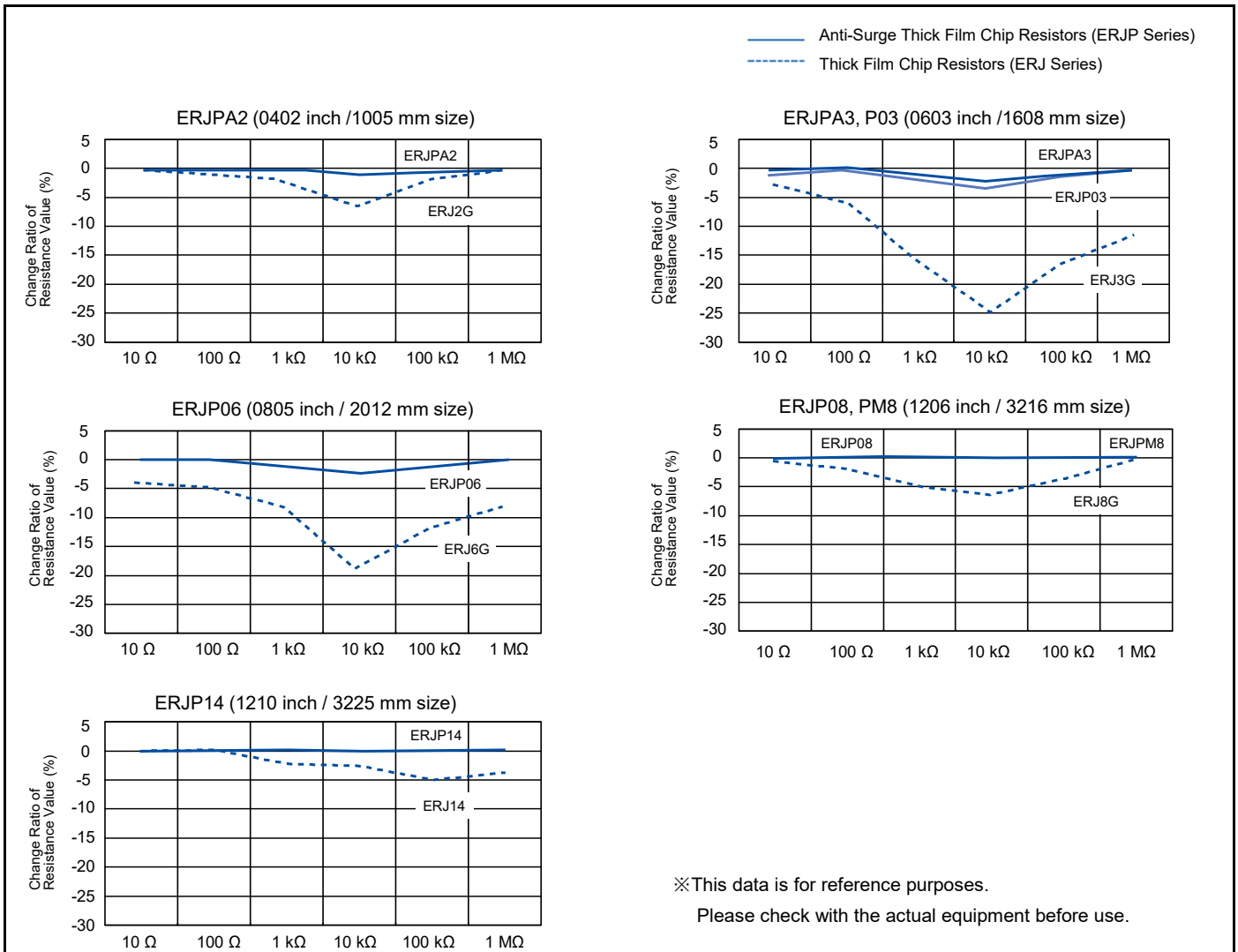

## Anti-Surge Thick Film Chip Resistors

### Performance

Test Item	Performance requirements $\Delta R$	Test conditions
Resistance	Within specified tolerance	20 °C
T. C. R.	Within specified T. C. R.	+25 °C / +155 °C (ERJPA2 : +125 °C)
Overload	$\pm 2\%$ Only when it is ERJP03 (D), P14 (D) : $\pm 0.5\%$	ERJP06 : Rated voltage $\times$ 1.77, 5 s ERJPA2, ERJPA3, ERJP08, ERJPM8 : Rated voltage $\times$ 2.0, 5 s ERJP03, ERJP14 : Rated voltage $\times$ 2.5, 5 s
Resistance to soldering heat	D : $\pm 0.5\%$ , F, J : $\pm 1\%$	270 °C, 10 s
Rapid change of temperature	$\pm 1\%$	-55 °C (30min.) / +155 °C (ERJPA2 : +125 °C) (30min.), 100 cycles
High temperature exposure	$\pm 1\%$	+155 °C, 1000 h
Damp heat, Steady state	$\pm 1\%$	60 °C, 90 % to 95 %RH, 1000 h
Load life in humidity 1 <small>(Applicable to rated ambient temperature-regulated products)</small>	$\pm 3\%$ Only when it is ERJP03 (D), P14 (D) : $\pm 1\%$	60 °C, 90 % to 95 %RH, Rated voltage, 1.5 h ON / 0.5 h OFF cycle, 1000 h
Load life in humidity 2 <small>(Applicable to rated ambient temperature-regulated products)</small>	$\pm 3\%$	85 °C, 85 %RH, Rated power 10%, Continuously power, 1000 h
Durability at rated ambient temperature or rated terminal part temperature	$\pm 3\%$ Only when it is ERJP03 (D), P14 (D) : $\pm 1\%$	Rated ambient temperature or rated terminal part temperature, Rated voltage, 1.5 h ON / 0.5 h OFF cycle, 1000 h



This series is not a recommended product.  
Not recommended for new design.

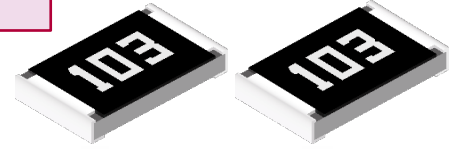

## Anti-Surge Thick Film Chip Resistors (Double-sided resistive elements structure)

ERJ P□W type

**ERJ P6W** series

### Features

- ESD surge characteristics superior to standard metal film resistors
  - Metal glaze thick film resistive element and three layers of electrodes
  - Suitable for both reflow and flow soldering
  - High power : 0.50 W, 2012(0805) size(ERJP6W)
  - High pulse characteristics : 1.5 times higher than 0805 inch size Anti-Surge thick film chip resistors (ERJP06)
  - Reference standards : IEC 60115-8, JIS C 5201-8, EIAJ RC-2134B
  - RoHS compliant
- As for packaging methods, land pattern, soldering conditions and safety precautions, please see data files.

### Explanation of part numbers

Note : Please check the "Ratings" for the presence/absence of part numbers for combinations of the symbols below.

1	2	3	4	5	6	7	8	9	10	11	12
E	R	J	P	6	W	F	1	0	0	2	V
Product code		Size (inch), Power rating			Resistance tolerance		Resistance value			Packaging methods	
Thick film chip resistors		Code	size	Power R.	Code	Tolerance	The first two or three digits are significant figures of resistance and the third or 4th one denotes number of zeros following. Three digit type (±5%), four digit type (±1%) Example: 222:2.2 kΩ, 1002:10 kΩ			Code	Packaging
		P6W	0805	0.5 W	F	±1 %				V	Punched carrier taping 4 mm pitch, 5,000 pcs.
					J	±5 %					

### Construction

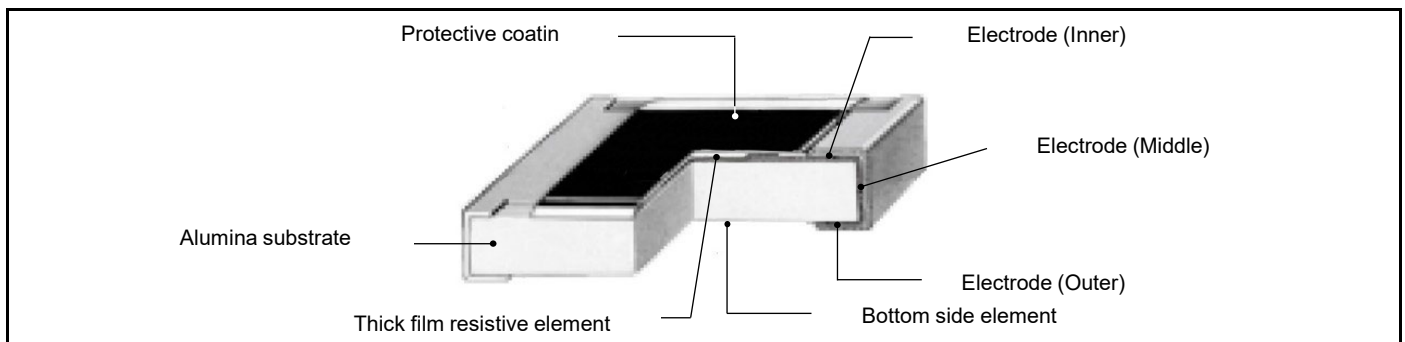

### Dimensions in mm (not to scale)

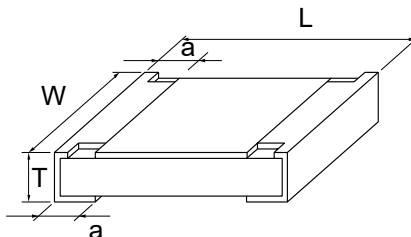

Type	Dimensions				Mass (Weight) (g/1000 pcs)
	L	W	a	T	
ERJP6W (0805)	2.00±0.20	1.25±0.20	0.35±0.20	0.65±0.10	6

# Anti-Surge Thick Film Chip Resistors (Double-sided resistive elements structure)

## Ratings

Part No. (inch size)	Power rating* <sup>1</sup> (70 °C) (W)	Limiting element voltage* <sup>2</sup> (V)	Maximum overload voltage* <sup>3</sup>	Resistance tolerance (%)	Resistance range (Ω)	T.C.R. (×10 <sup>-6</sup> /K)	Category temperature range (°C)
ERJP6W (0805)	0.5	150	200	± 1	10 to 1 M (E24,E96)	± 200	-55 to +155
				± 5	1 to 1 M (E24)	R < 10 Ω : -100 to +600 10 Ω ≤ R : ±200	

\*1: Use it on the condition that the case temperature is below 155 °C.

\*2: Overload (Short-time Overload) test voltage (SOTV) shall be determined from SOTV=2.5 × Power rating or max. Over load voltage listed above whichever less.

\*3: Rated Continuous Working Voltage (RCWV) shall be determined from RCWV= $\sqrt{\text{Power Rating} \times \text{Resistance Values}}$ , or Limiting Element Voltage listed above, whichever less.

## Power derating curve

For resistors operated in ambient temperatures above 70 °C, power rating shall be derated in accordance with the figure below.

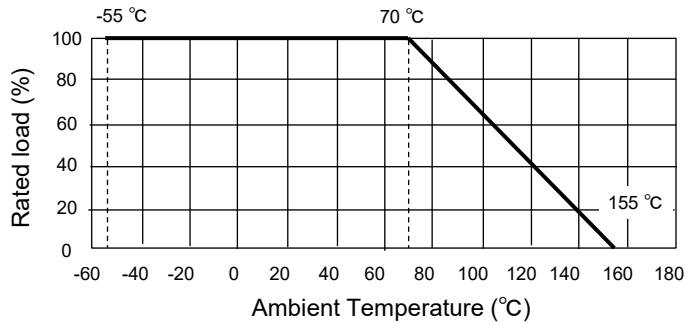

## ESD Characteristic

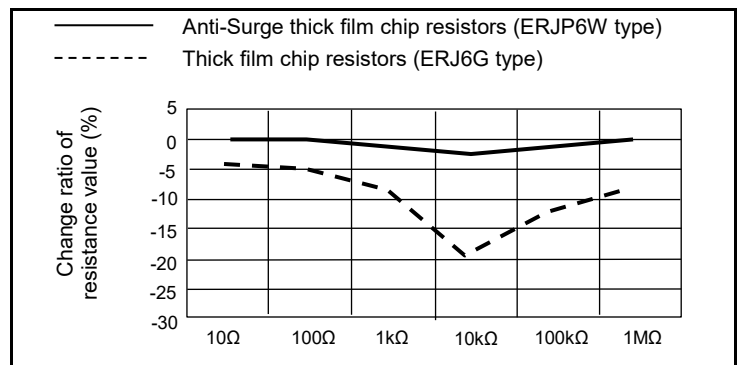
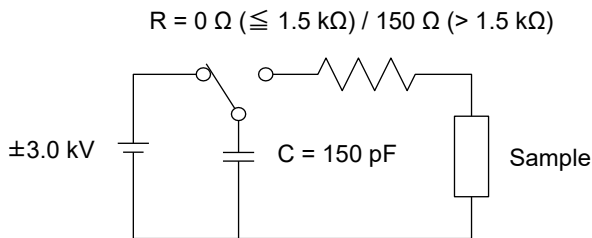



# Anti-Pulse Thick Film Chip Resistors

ERJ T type

**ERJ T06, T08, T14** series

**ERJ T14L** series

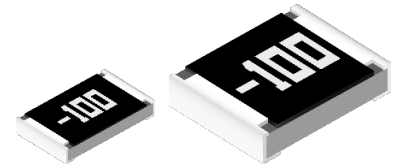

## Features

- Anti-Pulse characteristics  
High pulse characteristics achieved by the optimized trimming specifications (ERJT06, T08, T14)
- Further high pulse characteristics achieved by trimming-less specifications (ERJT14L)
- High reliability : Metal glaze thick film resistive element and three layers of electrodes
- Suitable for both reflow and flow soldering
- High power  
0.25 W : 0805 inch /2012 mm size(ERJT06)  
0.33 W : 1206 inch /3216 mm size(ERJT08)  
0.50 W : 1210 inch /3225 mm size(ERJT14, ERJT14L)
- Reference standard : IEC 60115-8, JIS C 5201-8, JEITA RC-2134C
- AEC-Q200 compliant
- RoHS compliant

■ As for packaging methods, land pattern, soldering conditions and safety precautions, please see data files.

## Explanation of part numbers

Note : Please check the "Ratings" for the presence/absence of part numbers for combinations of the symbols below.

### ● ERJ T06, T08, T14 series

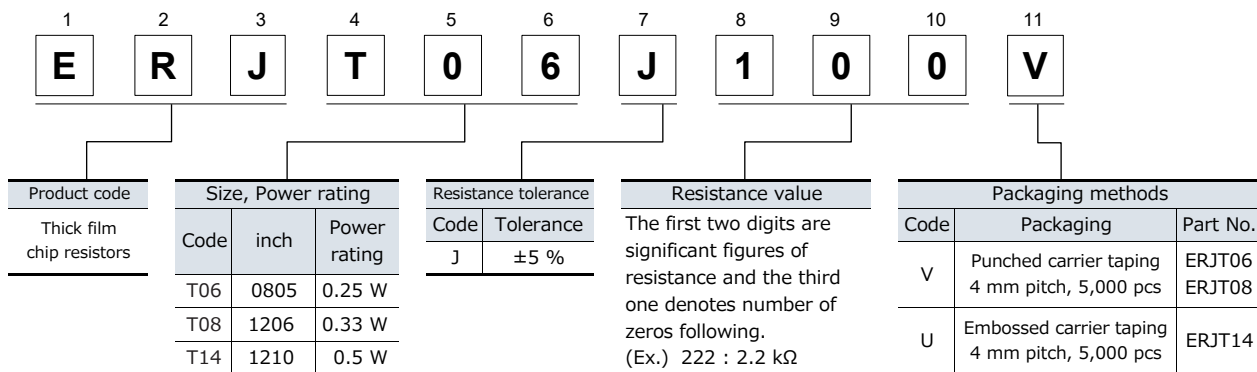

### ● ERJ T14L series

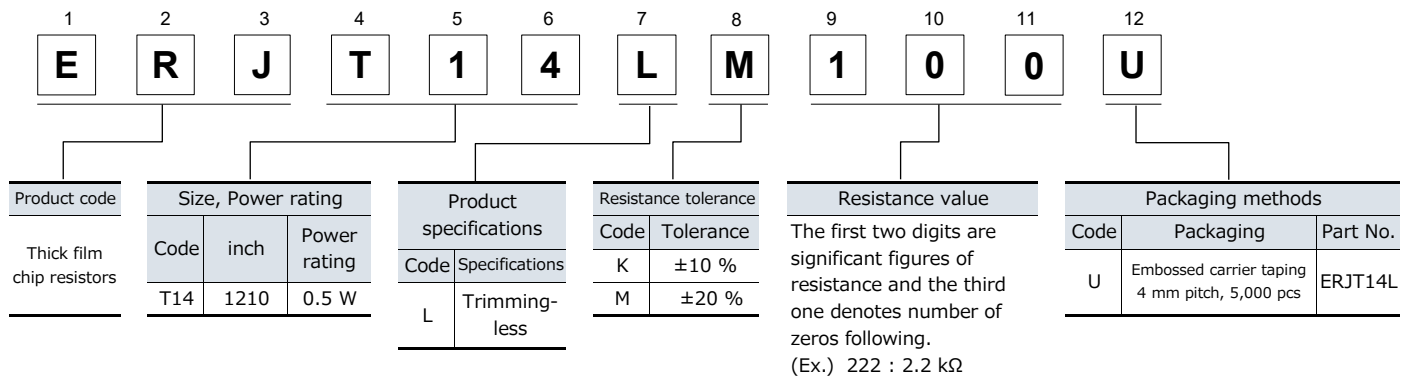

\* Please contact us for 0805 (inch) and 1206 (inch) size trimming-less types.

## Ratings

Part No. (inch size)	Power rating <sup>*1</sup> (70 °C)(W)	Limiting element voltage <sup>*2</sup> (V)	Maximum overload voltage <sup>*3</sup> (V)	Resistance tolerance (%)	Resistance range (Ω)	T.C.R. (×10 <sup>-6</sup> /K)	Category temperature range (°C)	AEC-Q200 Grade
ERJT06 (0805)	0.25	150	200	±5	1 to 1 M (E24)	R<10 Ω : -100 to +600 10 Ω≤R<33 Ω : ±300 33 Ω≤R : ±200	-55 to +155	Grade 0
ERJT08 (1206)	0.33	200	400	±5	1 to 1 M (E24)	R<10 Ω : -100 to +600 10 Ω≤R : ±200		
ERJT14 (1210)	0.50	200	400	±5	1 to 1 M (E24)	R<10 Ω : -100 to +600 10 Ω≤R : ±200		
ERJT14L (1210)	0.50	200	400	±10 ±20	1 to 1 M (E12)	R<10 Ω : -100 to +600 10 Ω≤R : ±200		

\*1: Use it on the condition that the case temperature is below the upper category temperature.

\*2: Rated Continuous Working Voltage (RCWV) shall be determined from  $RCWV = \sqrt{\text{Power Rating} \times \text{Resistance Value}}$ , or Limiting Element Voltage listed above, whichever less.

\*3: Overload Test Voltage (OTV) shall be determined from  $OTV = \text{Specified Magnification (refer to performance)} \times RCWV$  or Maximum Overload Voltage listed above, whichever less.

### Power derating curve

For resistors operated in ambient temperatures above 70 °C, power rating shall be derated in accordance with the figure on the right.

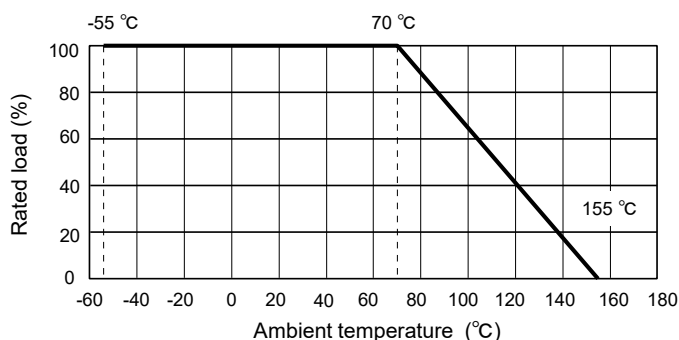

## Construction

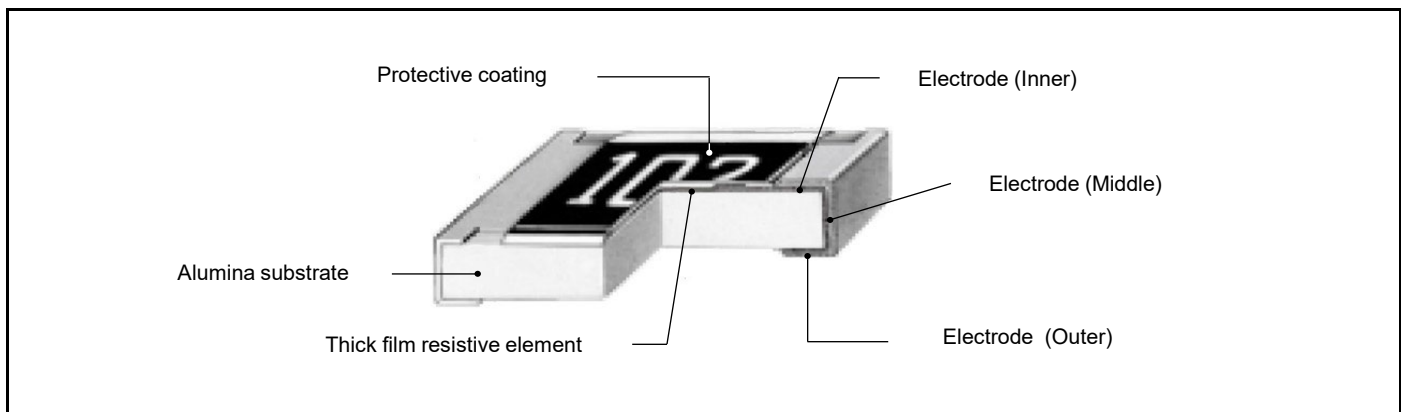

## Dimensions (not to scale)

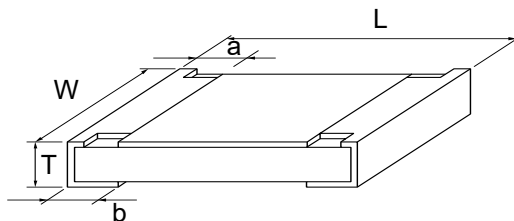

Part No.	Dimensions					Mass (Weight) (Reference) (g/1000 pcs)
	L	W	a	b	T	
ERJT06	2.00±0.20	1.25±0.10	0.25±0.20	0.40±0.20	0.60±0.10	4
ERJT08	3.20+0.05/-0.20	1.60+0.05/-0.15	0.40±0.20	0.50±0.20	0.60±0.10	10
ERJT14 ERJT14L	3.20±0.20	2.50±0.20	0.35±0.20	0.50±0.20	0.60±0.10	16

Unit : mm

## Limiting power curve

● In rush pulse Characteristic

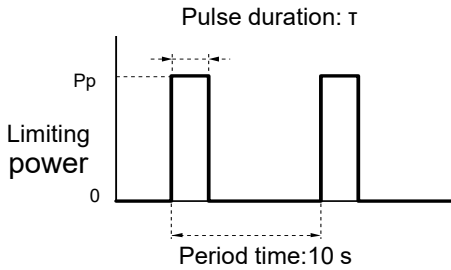

Test cycle : 1000 cycles  
Spec : Resistance value = within  $\pm 5\%$

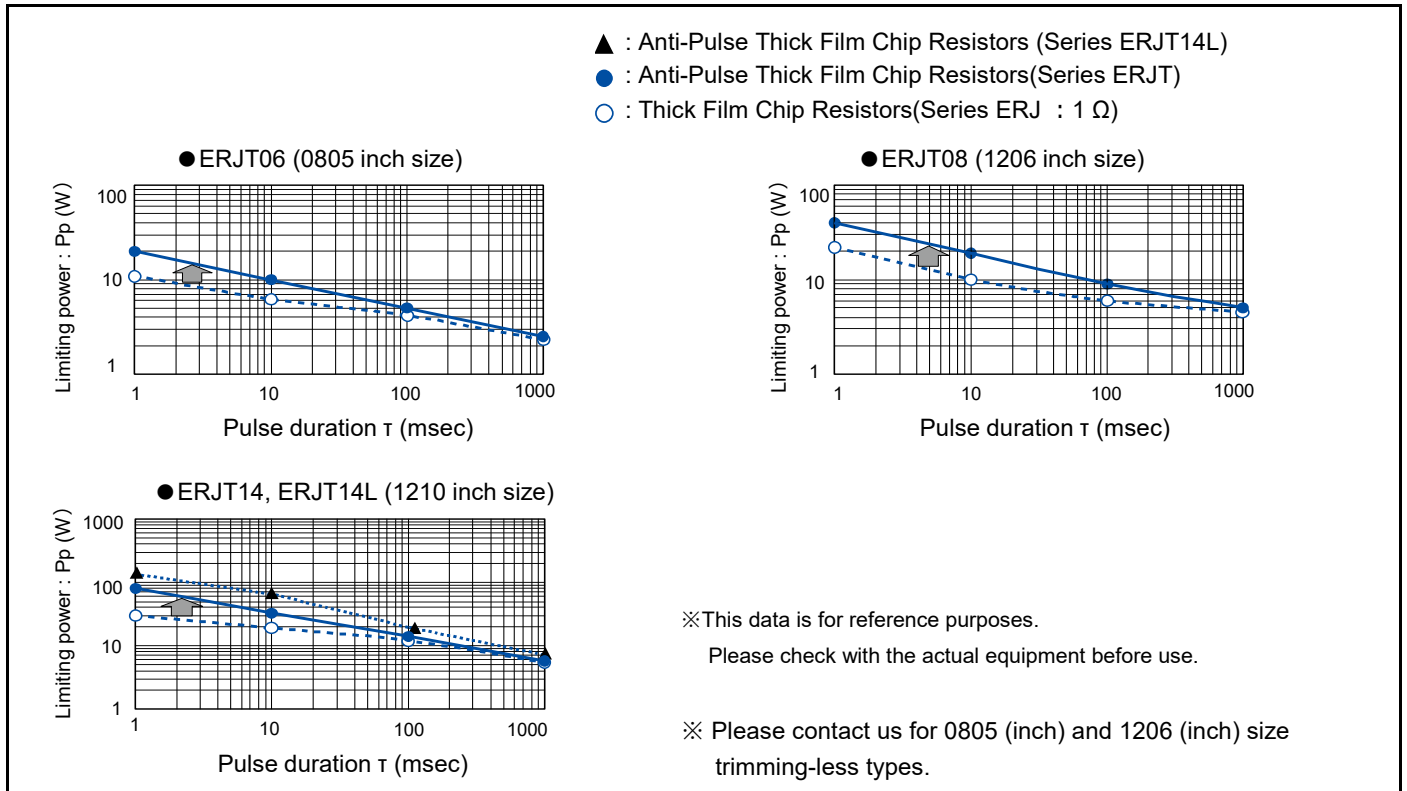

## Performance

Test Item	Performance requirements $\Delta R$	Test conditions
Resistance	Within specified tolerance	20 °C
T. C. R.	Within specified T. C. R.	+25 °C / +155 °C
Overload	$\pm 2\%$	Rated voltage $\times$ 2.5, 5 s
Resistance to soldering heat	$\pm 1\%$	270 °C $\pm$ 3 °C, 10 s $\pm$ 1 s
Rapid change of temperature	$\pm 1\%$	-55 °C (30 min.) / +155 °C (30 min.), 100 cycles
High temperature exposure	$\pm 1\%$	+155 °C, 1000 h
Damp heat, Steady state	$\pm 1\%$	60 °C $\pm$ 2 °C, 90 % to 95 %RH, 1000 h
Load life in humidity	$\pm 3\%$	60 °C $\pm$ 2 °C, 90 % to 95 %RH, Rated voltage , 1.5 h ON / 0.5 h OFF cycle, 1000 h
Endurance at 70 °C	$\pm 3\%$	70 °C $\pm$ 2 °C, Rated voltage, 1.5 h ON / 0.5 h OFF cycle, 1000 h

## Anti-Sulfurated Thick Film Chip Resistors

ERJ S type (Au-based inner electrode type)

**ERJ S02, S03, S06, S08, S14** series

**ERJ S12, S1D, S1T** series

ERJ U type (Ag-Pd-based inner electrode type)

**ERJ U0X, U01, U02, U03, U06, U08, U14** series

**ERJ U12, U1D, U1T, U6S, U6Q** series

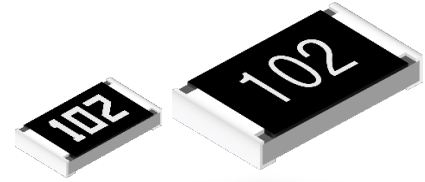

### Features

- High resistance to sulfurization achieved by adopting an Au-based inner electrode (Series ERJS) and Ag-Pd-based inner electrode (Series ERJU )
- High reliability : Metal glaze thick film resistive element and three layers of electrodes
- Suitable for both reflow and flow soldering
- Low resistance type : ERJU6S, U6Q series : 0.1 Ω to 1 Ω
- Reference standard : IEC 60115-8, JIS C 5201-8, JEITA RC-2134C
- AEC-Q200 compliant (except ERJU0X, ERJU01)
- RoHS compliant

■ As for packaging methods, land pattern, soldering conditions and safety precautions, please see data files.

### Explanation of part numbers

Note : Please check the "Ratings" for the presence/absence of part numbers for combinations of the symbols below.

- ERJ S02 to ERJS1T, ERJU0X to ERJU1T series

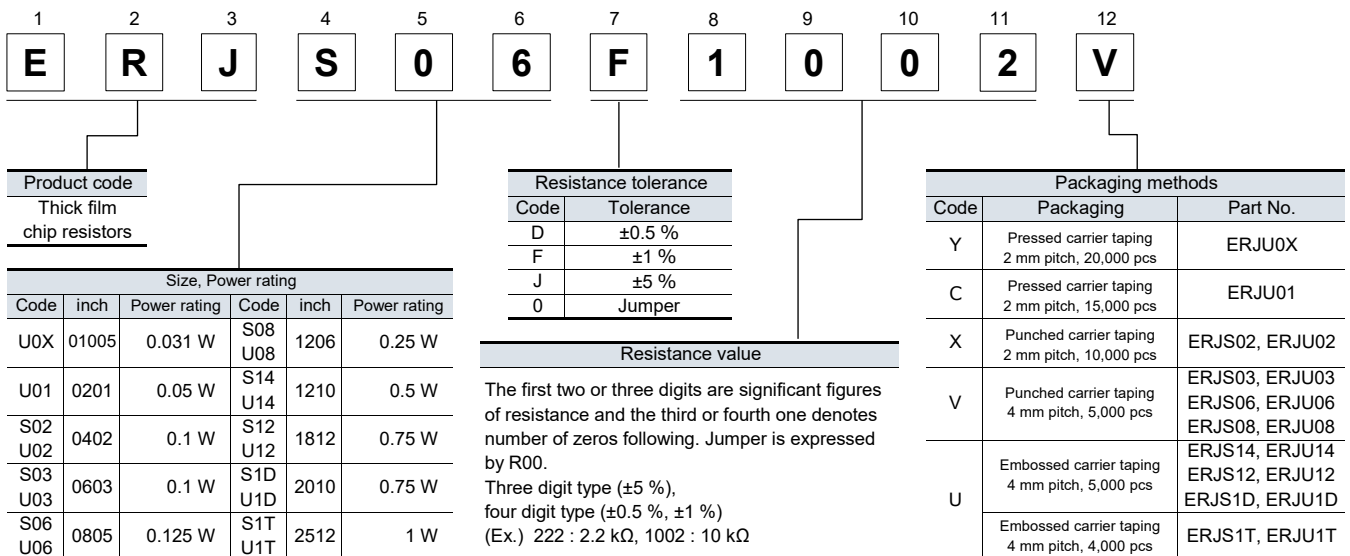

- ERJ U6S, U6Q series

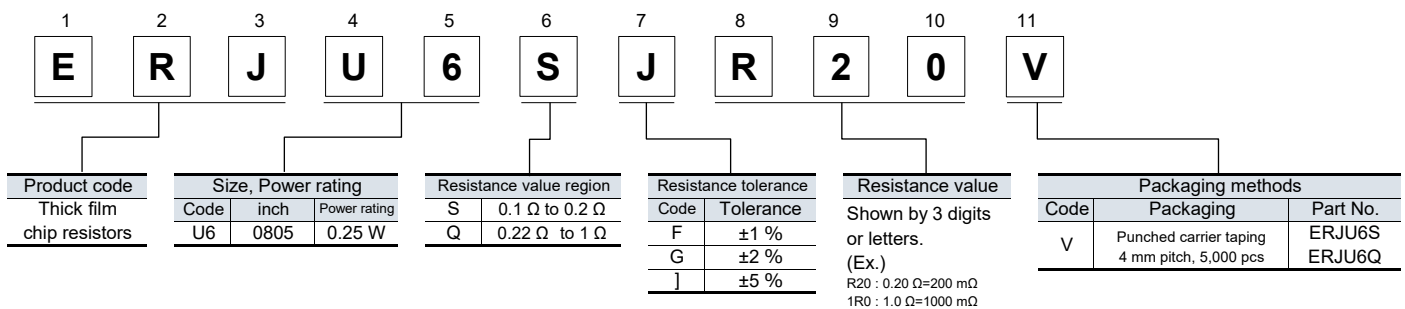

## Anti-Sulfurated Thick Film Chip Resistors

### Ratings

Part No. (inch size)	Power rating <sup>*1</sup> (70 °C)(W)	Limiting element voltage <sup>*2</sup> (V)	Maximum overload voltage <sup>*3</sup> (V)	Resistance tolerance (%)	Resistance range (Ω)	T.C.R. (×10 <sup>-6</sup> /K)	Category temperature range (°C)	AEC-Q200 Grade
ERJU0X (01005)	0.031	15	30	±1	10 to 1 M (E24, E96)	R<10 Ω : -100 to +600	-55 to +125	-
				±5	1 to 1 M (E24)	10 Ω≤R<100 Ω : ±300 100 Ω≤R : ±200		
ERJU01 (0201)	0.05	25	50	±1	10 to 1 M (E24, E96)	R<10 Ω : -100 to +600	-55 to +155	Grade 0
				±5	1 to 1 M (E24)	10 Ω to 1 MΩ : ±200		
ERJS02 ERJU02 (0402)	0.1	50	100	±0.5, ±1	1 to 1 M (E24, E96)	1 MΩ<R : -400 to +150	-55 to +155	Grade 0
ERJS03 ERJU03 (0603)				±5	ERJS02: 1 to 3.3 M (E24) ERJU02: 1 to 10 M			
ERJS06 ERJU06 (0805)	0.125	150	200	±0.5, ±1	1 to 1 M (E24, E96)	R<10 Ω : -100 to +600	-55 to +155	Grade 0
				±5	1 to 10 M (E24)			
ERJS08 ERJU08 (1206)	0.25	200	400	±0.5, ±1	1 to 1 M (E24, E96)	10 Ω to 1 MΩ : ±200 (± 5 %) : ±100 (±0.5 %, ±1 %)	-55 to +155	Grade 0
				±5	1 to 10 M (E24)			
ERJS14 ERJU14 (1210)	0.5	200	400	±0.5, ±1	1 to 1 M (E24, E96)	1 MΩ<R : -400 to +150	-55 to +155	Grade 0
				±5	1 to 10 M (E24)			
ERJS12 ERJU12 (1812)	0.75	200	500	±0.5, ±1	1 to 1 M (E24, E96)	1 MΩ<R : -400 to +150	-55 to +155	Grade 0
				±5	1 to 10 M (E24)			
ERJS1D ERJU1D (2010)	0.75	200	500	±0.5, ±1	1 to 1 M (E24, E96)	1 MΩ<R : -400 to +150	-55 to +155	Grade 0
				±5	1 to 10 M (E24)			
ERJS1T ERJU1T (2512)	1.0	200	500	±0.5, ±1	1 to 1 M (E24, E96)	1 MΩ<R : -400 to +150	-55 to +155	Grade 0
				±5	1 to 10 M (E24)			

\*1: Use it on the condition that the case temperature is below the upper category temperature.

\*2: Rated Continuous Working Voltage (RCWV) shall be determined from  $RCWV = \sqrt{\text{Power Rating} \times \text{Resistance Value}}$ , or Limiting Element Voltage listed above, whichever less.

\*3: Overload Test Voltage (OTV) shall be determined from  $OTV = \text{Specified Magnification (refer to performance)} \times RCWV$  or Maximum Overload Voltage listed above, whichever less.

### [Low resistance type]

Part No. (inch size)	Power rating <sup>*1</sup> (70 °C)(W)	Resistance tolerance (%)	Resistance range (Ω)	T.C.R. (×10 <sup>-6</sup> /K)	Category temperature range (°C)	AEC-Q200 Grade
ERJU6S (0805)	0.25	±1, ±2, ±5	0.1 to 0.2 (E24)	0 to +150	-55 to +155	Grade 0
ERJU6Q (0805)			0.22 to 1 (E24)			

\*1: Use it on the condition that the case temperature is below the upper category temperature.

• Rated Continuous Working Voltage (RCWV) shall be determined from  $RCWV = \sqrt{\text{Power Rating} \times \text{Resistance Value}}$ .

• Overload Test Voltage (OTV) shall be determined from  $OTV = \text{Specified Magnification (refer to performance)} \times RCW$ .

### [For jumper]

Part No.	Resistance	Rated current	Maximum overload current <sup>*1</sup>
ERJU0X	100 mΩ or less	0.5 A	1 A
ERJU01			
ERJS02,ERJU02		1 A	2 A
ERJS03,ERJU03			
ERJS06,ERJU06		2 A	4 A
ERJS08,ERJU08			
ERJS14,ERJU14			
ERJS12,ERJU12			
ERJS1D,ERJU1D			
ERJS1T,ERJU1T			

\*1: Overload test current

### Power derating curve

For resistors operated in ambient temperatures above 70 °C, power rating shall be derated in accordance with the figure below.

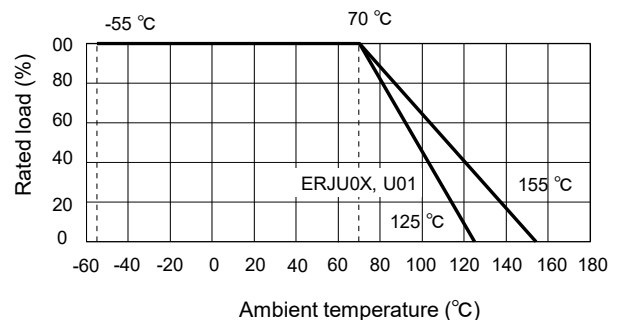

## Anti-Sulfurated Thick Film Chip Resistors

### Construction

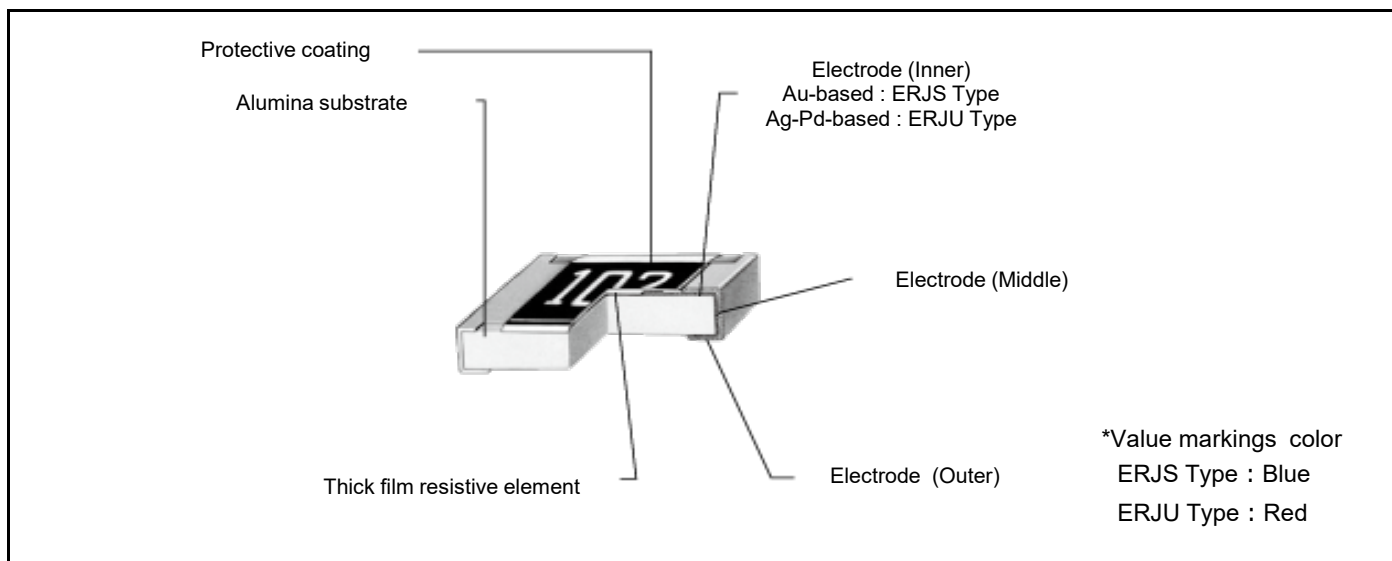

### Dimensions (not to scale)

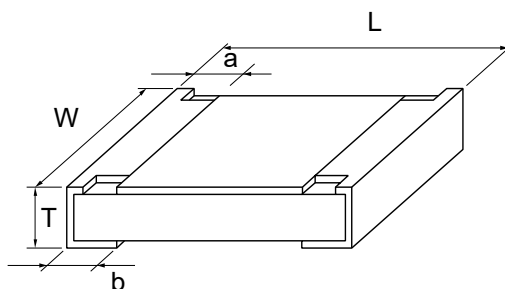

Unit : mm

Part No.	Dimensions					Mass (Weight) (Reference) (g/1000 pcs)
	L	W	a	b	T	
ERJU0X	0.40±0.02	0.20±0.02	0.10±0.03	0.10±0.03	0.13±0.02	0.04
ERJU01	0.60±0.03	0.30±0.03	0.10±0.05	0.15±0.05	0.23±0.03	0.15
ERJS02 ERJU02	1.00±0.05	0.50±0.05	0.20±0.10	0.25±0.10	0.35±0.05	0.8
ERJS03 ERJU03	1.60±0.15	0.80+0.15/-0.05	0.30±0.20	0.30±0.15	0.45±0.10	2
ERJS06 ERJU06	2.00±0.20	1.25±0.10	0.40±0.20	0.40±0.20	0.60±0.10	4
ERJU6□	2.00±0.20	1.25±0.10	0.45±0.20	0.45±0.20	0.55±0.10	6
ERJS08 ERJU08	3.20+0.05/-0.20	1.60+0.05/-0.15	0.50±0.20	0.50±0.20	0.60±0.10	10
ERJS14 ERJU14	3.20±0.20	2.50±0.20	0.50±0.20	0.50±0.20	0.60±0.10	16
ERJS12 ERJU12	4.50±0.20	3.20±0.20	0.50±0.20	0.50±0.20	0.60±0.10	27
ERJS1D ERJU1D	5.00±0.20	2.50±0.20	0.60±0.20	0.60±0.20	0.60±0.10	27
ERJS1T ERJU1T	6.40±0.20	3.20±0.20	0.65±0.20	0.60±0.20	0.60±0.10	45

### Performance

● ERJ S02 to ERJS1T, ERJU0X to ERJU1T series

Test item	Performance requirements $\Delta R$		Test conditions
	Resistor type	Jumper type	
Resistance	Within specified tolerance	100 m $\Omega$ or less	20 °C
T. C. R.	Within Specified T. C. R.	200 m $\Omega$ or less	+25 °C / +155 °C (ERJU0X,U01 : +25 °C / +125 °C)
Overload	$\pm 2$ %	100 m $\Omega$ or less	Rated voltage $\times$ 2.5, 5 s Jumper type : Max. overload current, 5 s
Resistance to soldering heat	$\pm 1$ %	100 m $\Omega$ or less	270 °C, 10 s
Rapid change of temperature	$\pm 1$ %	100 m $\Omega$ or less	-55 °C (30min.)/+155 °C (ERJU0X,U01 : +125 °C) (30min.), 100 cycles
High temperature exposure	$\pm 1$ %	100 m $\Omega$ or less	+155 °C (ERJU0X,U01 : +125 °C), 1000 h
Damp heat, Steady state	$\pm 1$ %	100 m $\Omega$ or less	60 °C, 90 % to 95 %RH, 1000 h
Load life in humidity	$\pm 3$ %	100 m $\Omega$ or less	60 °C, 90 % to 95 %RH, Rated voltage (Jumper type : Rated current), 1.5 h ON / 0.5 h OFF cycle, 1000 h
Endurance at 70 °C	$\pm 3$ %	100 m $\Omega$ or less	70 °C, Rated voltage (Jumper type : Rated current), 1.5 h ON / 0.5 h OFF cycle, 1000 h

● ERJ U6S, U6Q series

Test Item	Performance requirements $\Delta R$	Test conditions
Resistance	Within specified tolerance	20 °C
T. C. R.	Within specified T. C. R.	+25 °C / +125 °C
Overload	$\pm 1$ %	Rated voltage $\times$ 2.5, 5 s
Resistance to soldering heat	$\pm 1$ %	270 °C, 10 s
Rapid change of temperature	$\pm 1$ %	-55 °C (30 min.) / +125 °C (30min.), 100 cycles
High temperature exposure	$\pm 1$ %	+155 °C, 1000 h
Damp heat, Steady state	$\pm 1$ %	60 °C, 90 % to 95 %RH, 1000 h
Load life in humidity	$\pm 3$ %	60 °C, 90 % to 95 %RH, Rated voltage 1.5 h ON / 0.5 h OFF cycle, 1000 h
Endurance at 70 °C	$\pm 3$ %	70 °C, Rated voltage, 1.5 h ON / 0.5 h OFF cycle, 1000 h

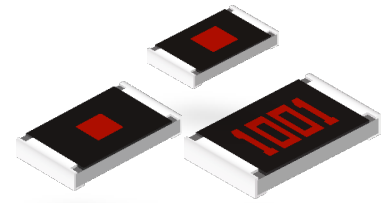

# Anti-Sulfurated Thick Film Chip Resistors (Precision Type)

ERJ U□R type (Ag-Pd-based inner electrode type)

**ERJ U2R, U3R, U6R** series

## Features

- High resistance to sulfurization achieved by adopting an Ag-Pd-based inner electrode.
- High precision : Resistance tolerance :  $\pm 0.5\%$ , TCR :  $\pm 50 \times 10^{-6}/K$
- High reliability : Metal glaze thick film resistive element and three layers of electrodes.
- Suitable for both reflow and flow soldering.
- Reference standard : IEC 60115-8, JIS C 5201-8, JEITA RC-2134C
- AEC-Q200 compliant
- RoHS compliant

■ As for packaging methods, land pattern, soldering conditions and safety precautions, please see data files.

## Explanation of part numbers

Note : Please check the "Ratings" for the presence/absence of part numbers for combinations of the symbols below.

### ● ERJ U2R, U3R, U6R series

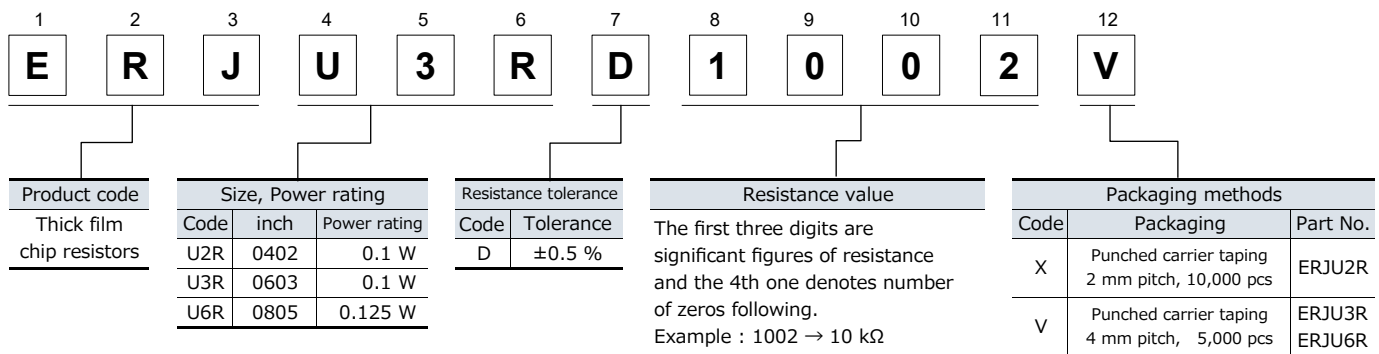

## Ratings

Part No. (inch size)	Power rating* <sup>1</sup> (70 °C) (W)	Limiting element voltage* <sup>2</sup> (V)	Maximum overload voltage* <sup>3</sup> (V)	Resistance tolerance (%)	Resistance range (Ω)	T.C.R. ( $\times 10^{-6}/K$ )	Category temperature range (°C)	AEC-Q200 Grade
ERJU2R (0402)	0.1	50	100	$\pm 0.5$	100 to 100 k (E24, E96)	$\pm 50$	-55 to +155	Grade 0
ERJU3R (0603)	0.1	75	150	$\pm 0.5$	100 to 100 k (E24, E96)			
ERJU6R (0805)	0.125	150	200	$\pm 0.5$	100 to 100 k (E24, E96)			

\*1 : Use it on the condition that the case temperature is below the upper category temperature.

\*2 : Rated continuous working voltage (RCWV) shall be determined from  $RCWV = \sqrt{\text{Power rating} \times \text{Resistance value}}$ , or limiting element voltage listed above, whichever less.

\*3 : Overload test voltage (OTV) shall be determined from  $OTV = \text{Specified magnification (refer to performance)} \times RCWV$  or maximum overload voltage listed above, whichever less.

### Power derating curve

For resistors operated in ambient temperatures above 70 °C, power rating shall be derated in accordance with the figure on the right.

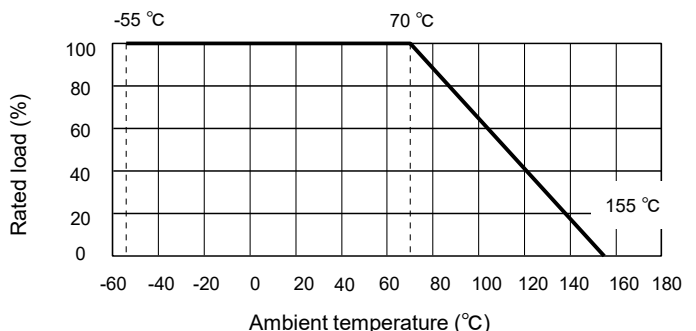



## Anti-Sulfurated Thick Film Chip Resistors (Precision Type)

### Construction

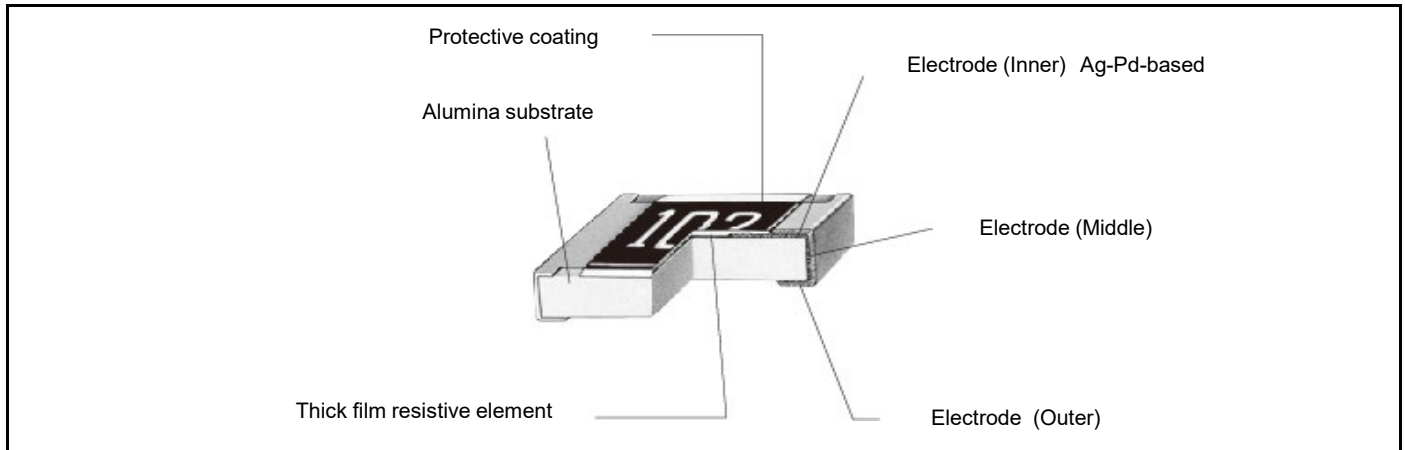

### Dimensions (not to scale)

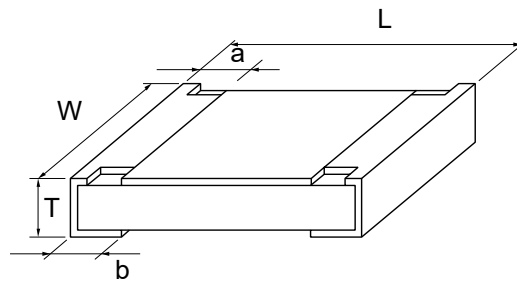

Part No.	Dimensions					Unit : mm
	L	W	a	b	T	Mass (Weight) (Reference) (g/1000 pcs)
ERJU2R	1.00±0.05	0.50±0.05	0.20±0.10	0.25±0.10	0.35±0.05	0.8
ERJU3R	1.60±0.15	0.80+0.15/-0.05	0.30±0.20	0.30±0.15	0.45±0.10	2
ERJU6R	2.00±0.20	1.25±0.10	0.40±0.20	0.40±0.20	0.60±0.10	4

### Performance

Test Item	Performance requirements ΔR	Test conditions
Resistance	Within specified tolerance	20 °C
T. C. R.	Within specified T. C. R.	+25 °C / +155 °C
Overload	±2 %	Rated voltage × 2.5, 5 s
Resistance to soldering heat	±1 %	270 °C, 10 s
Rapid change of temperature	±1 %	-55 °C (30 min.) / +155 °C (30 min.), 100 cycles
High temperature exposure	±1 %	+155 °C, 1000 h
Damp heat, Steady state	±1 %	60 °C, 90 % to 95 %RH, 1000 h
Load life in humidity	±2 %	60 °C, 90 % to 95 %RH, Rated voltage, 1.5 h ON / 0.5 h OFF cycle, 1000 h
Endurance at 70 °C	±2 %	70 °C, Rated voltage, 1.5 h ON / 0.5 h OFF cycle, 1000 h

# Anti-Sulfurated Thick Film Chip Resistors (Anti-Surge Type)

ERJ UP type

ERJ UP3, UP6, UP8 series

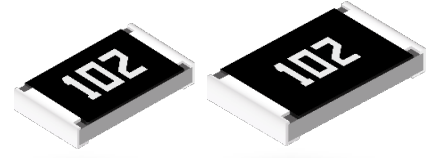

## Features

- High resistance to sulfurization achieved by adopting Anti-Sulfurated electrode material (Ag-Pd-based inner electrode) and structure
- ESD surge characteristics superior to standard metal film resistors
- High reliability : Metal glaze thick film resistive element and three layers of electrodes
- Suitable for both reflow and flow soldering
- High power
  - 0.25 W : 0603 inch / 1608 mm size (ERJUP3)
  - 0.50 W : 0805 inch / 2012 mm size (ERJUP6)
  - 0.66 W : 1206 inch / 3216 mm size (ERJUP8)
- Reference standard : IEC 60115-8, JIS C 5201-8, JEITA RC-2134C
- AEC-Q200 compliant
- RoHS compliant

■ As for packaging methods, land pattern, soldering conditions and safety precautions, please see data files.

## Explanation of part numbers

Note : Please check the "Ratings" for the presence/absence of part numbers for combinations of the symbols below.

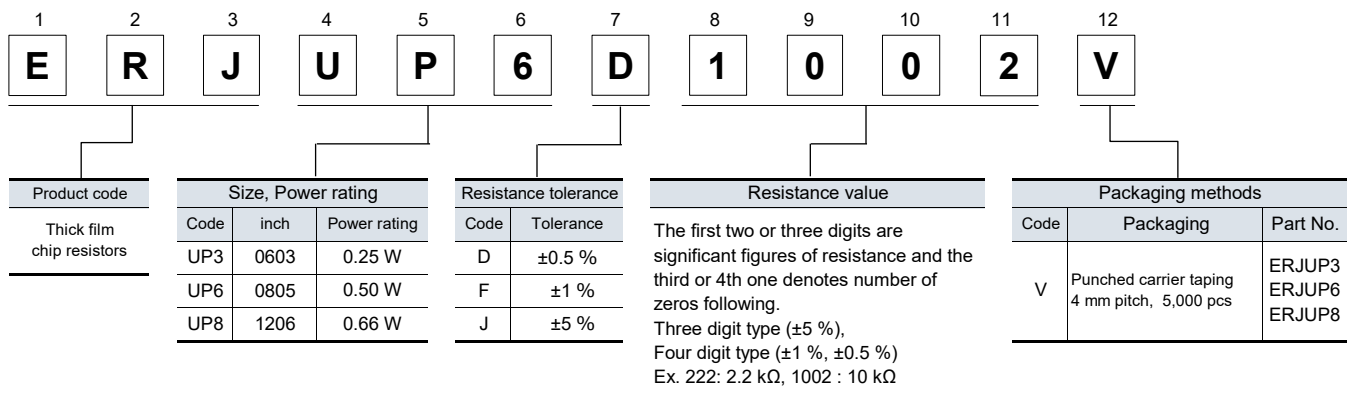

## Ratings

Part No. (inch size)	Power rating*1 (70 °C) (W)	Limiting element voltage*2 (V)	Maximum overload voltage*3 (V)	Resistance tolerance (%)	Resistance range (Ω)	T.C.R. (×10 <sup>-6</sup> /K)	Category temperature range (°C)	AEC-Q200 Grade
ERJUP3 (0603)	0.25	150	200	±0.5, ±1	10 to 1 M (E24, E96)	±100	-55 to +155	Grade 0
				±5	1 to 1.5 M (E24)	±200		
ERJUP6 (0805)	0.50	400	600	±0.5, ±1	10 to 1 M (E24, E96)	±100		
				±5	1 to 3.3 M (E24)	R<10 Ω : -100 to +600 10 Ω≤R : ±200		
ERJUP8 (1206)	0.66	500	1000	±0.5, ±1	10 to 1 M (E24, E96)	±100		
				±5	1 to 10 M (E24)	R<10 Ω : -100 to +600 10 Ω≤R : ±200		

\*1: Use it on the condition that the case temperature is below the upper category temperature.

\*2: Rated Continuous Working Voltage (RCWV) shall be determined from  $RCWV = \sqrt{\text{Power Rating} \times \text{Resistance Value}}$ , or Limiting Element Voltage listed above, whichever less.

\*3: Overload Test Voltage (OTV) shall be determined from  $OTV = \text{Specified Magnification (refer to performance)} \times RCWV$  or Maximum Overload Voltage listed above, whichever less.

## Anti-Sulfurated Thick Film Chip Resistors (Anti-Surge Type)

### Ratings

#### Power derating curve

For resistors operated in ambient temperatures above 70 °C, power rating shall be derated in accordance with the figure on the right.

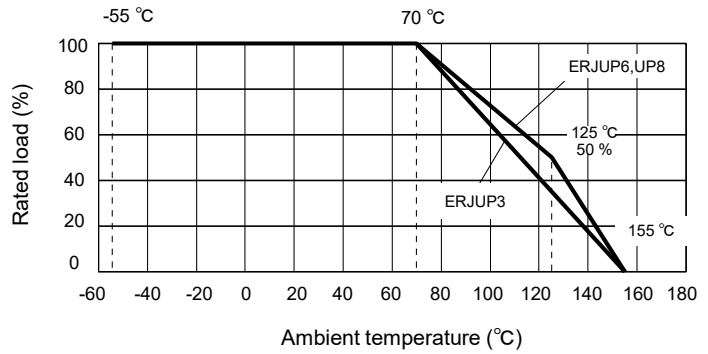

### Construction

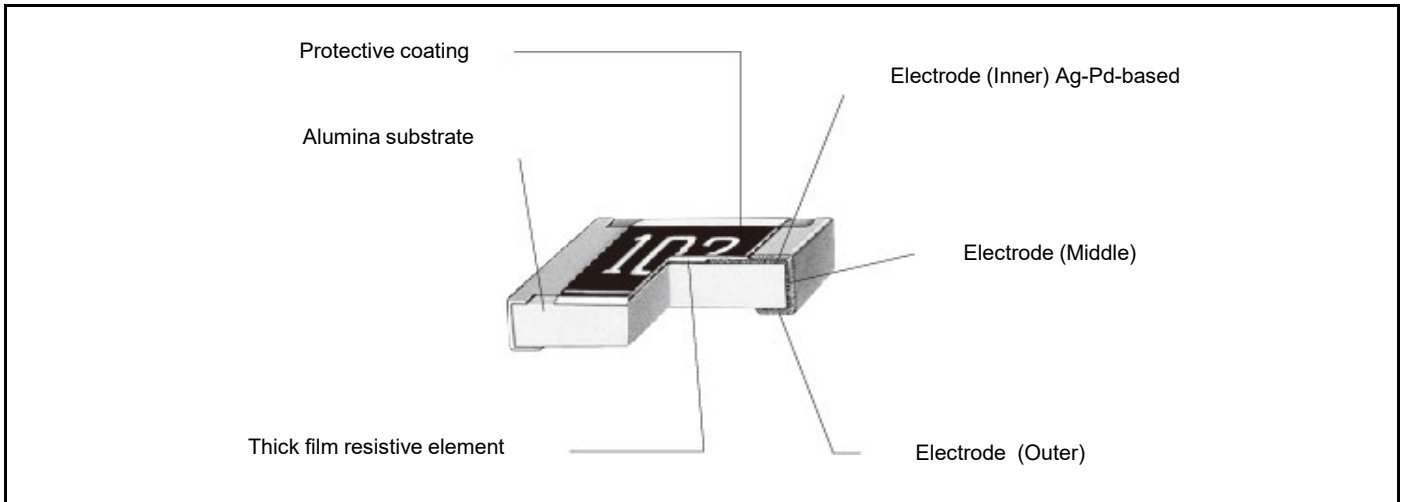

### Dimensions in mm (not to scale)

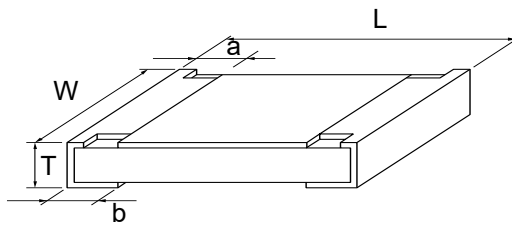

Part No.	Dimensions					Mass (Weight) (Reference) (g/1000 pcs)
	L	W	a	b	T	
ERJUP3	1.60±0.15	0.80+0.15/-0.05	0.15+0.15/-0.10	0.25±0.10	0.45±0.10	2
ERJUP6	2.00±0.20	1.25±0.10	0.25±0.20	0.40±0.20	0.60±0.10	4
ERJUP8	3.20+0.05/-0.20	1.6+0.05/-0.15	0.40±0.20	0.50±0.20	0.60±0.10	10

Unit : mm

# Anti-Sulfurated Thick Film Chip Resistors (Anti-Surge Type)

## ESD Characteristic

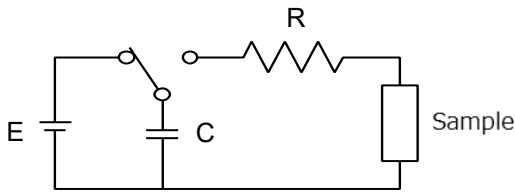

R	R=0 Ω(≤1.5 kΩ) / 150 Ω(> 1.5 kΩ)
C	150 pF
E	±3 kV

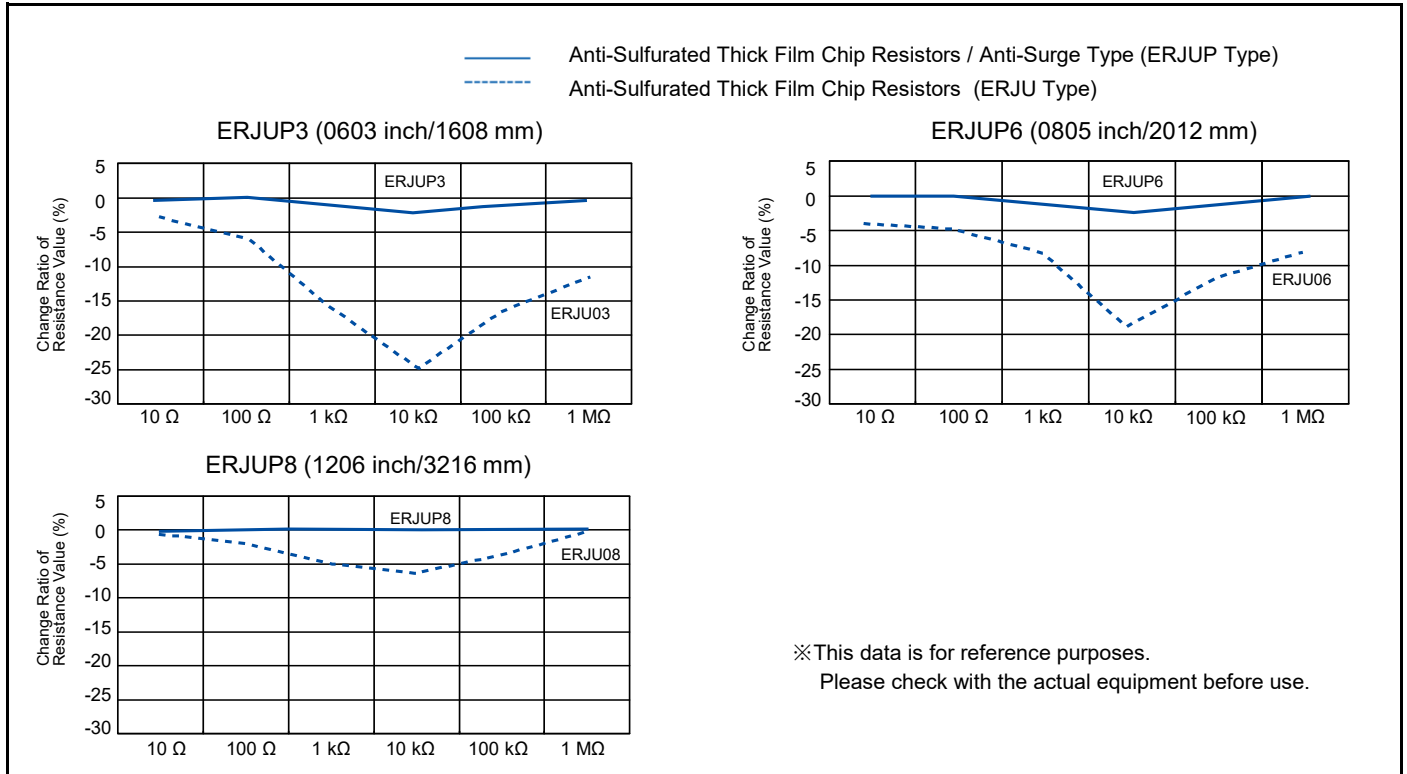

## Performance

Test Item	Performance requirements ΔR	Test conditions
Resistance	Within specified tolerance	20 °C
T. C. R.	Within specified T. C. R.	+25 °C / +155 °C
Overload	±2 %	ERJUP6 : Rated voltage x 1.77, 5 s ERJUP3, ERJUP8 : Rated voltage x 2.0, 5 s
Resistance to soldering heat	D : ±0.5 % F, J : ±1 %	270 °C, 10 s
Rapid change of temperature	±1 %	-55 °C (30 min.) / +155 °C (30 min.), 100 cycles
High temperature exposure	±1 %	+155 °C, 1000 h
Damp heat, Steady state	±1 %	60 °C, 90 % to 95 %RH, 1000 h
Load life in humidity	±3 %	60 °C, 90 % to 95 %RH, Rated voltage, 1.5 h ON / 0.5 h OFF cycle, 1000 h
Endurance at 70 °C	±3 %	70 °C, Rated voltage, 1.5 h ON / 0.5 h OFF cycle, 1000 h

# Anti-Sulfurated High Power Chip Resistors (Wide Terminal Type)

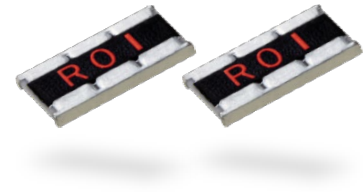

ERJ C type

**ERJ C1** series

## Features

- High resistance to sulfurization achieved by adopting Anti-Sulfurated electrode material (Ag-Pd-based inner electrode) and structure (Covered electrode)
- High solder-joint reliability by wide terminal construction
- Excellent heat dissipation characteristics by wide terminal construction
- AEC-Q200 compliant
- RoHS compliant

## Recommended applications

- Motor control circuit of the industrial equipment
  - Automotive electronic circuits including ECUs (Electrical control unit), anti-lock breaking systems and air-bag systems
  - Current sensing for power supply circuits in a variety of equipment
- As for packaging methods, land pattern, soldering conditions and safety precautions, please see data files.

## Explanation of part numbers

Note : Please check the "Ratings" for the presence/absence of part numbers for combinations of the symbols below.

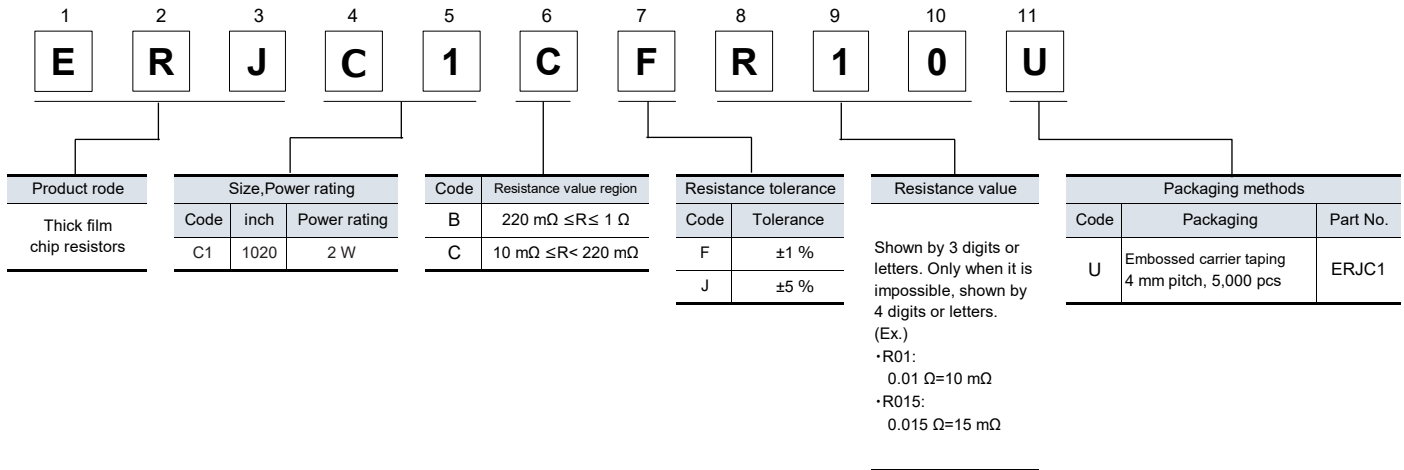

## Ratings

Part No. (inch size)	Power rating*1 (70 °C) (W)	Resistance tolerance (%)	Resistance range (Ω)	T.C.R. (×10 <sup>-6</sup> /K)	Category temperature range (°C)	AEC-Q200 Grade
ERJC1 (1020)	2	±1	10 m to 1 (E24)	10 mΩ ≤ R < 22 mΩ : 0 to +350 22 mΩ ≤ R < 47 mΩ : 0 to +200 47 mΩ ≤ R < 100 mΩ : 0 to +150 100 mΩ ≤ R ≤ 1 Ω : ±100	-55 to +155	Grade 0
		±5		10 mΩ ≤ R < 22 mΩ : 0 to +350 22 mΩ ≤ R < 100 mΩ : 0 to +200 100 mΩ ≤ R ≤ 1 Ω : ±200		

\*1: Use it on the condition that the case temperature is below the upper category temperature.

- Rated Continuous Working Voltage (RCWV) shall be determined from  $RCWV = \sqrt{\text{Power Rating} \times \text{Resistance Value}}$ .
- Overload Test Voltage (OTV) shall be determined from  $OTV = \text{Specified Magnification (refer to performance)} \times RCW$ .

# Anti-Sulfurated High Power Chip Resistors (Wide Terminal Type)

## Ratings

### Power derating curve

For resistors operated in ambient temperatures above 70 °C, power rating shall be derated in accordance with the figure on the right.

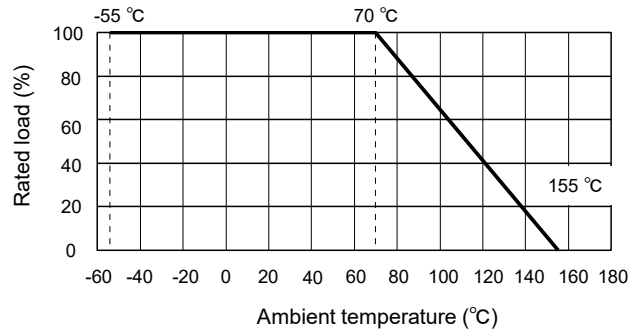

## Construction

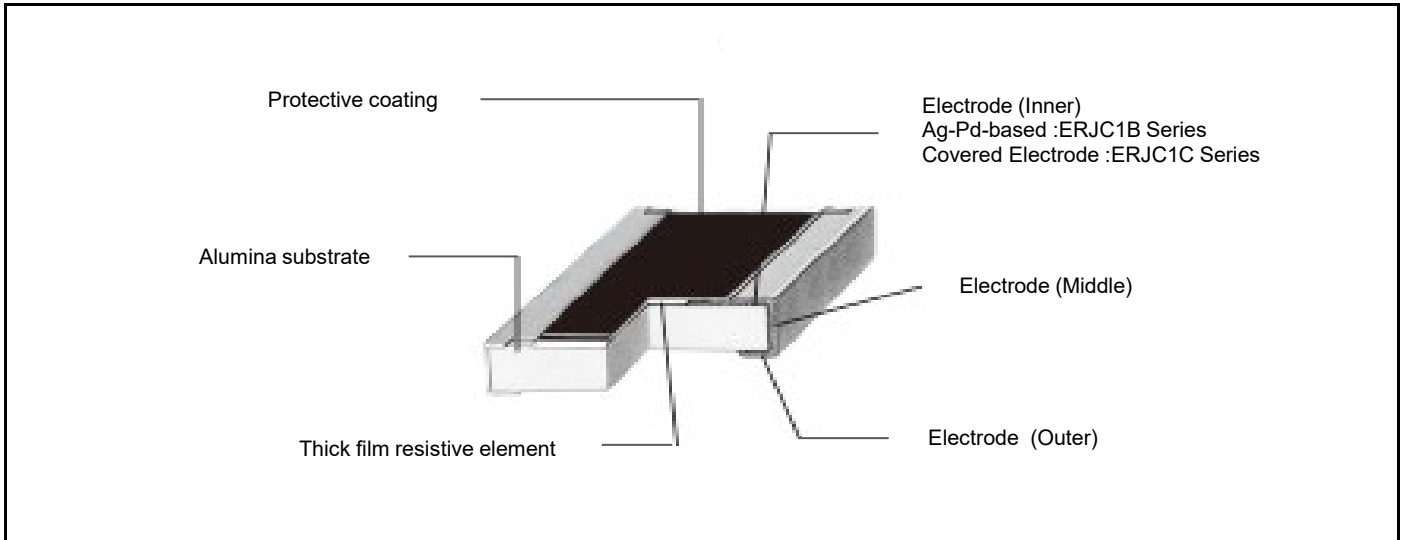

## Dimensions (not to scale)

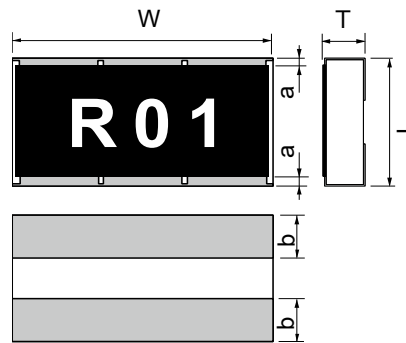

Unit : mm

Part No.	Dimensions					Mass (Weight) (Reference) (g/1000 pcs)
	L	W	a	b	T	
ERJC1B	2.50±0.20	5.00±0.20	0.35±0.20	0.90±0.20	0.55±0.20	27
ERJC1C			0.60±0.20			

## Circuit configuration

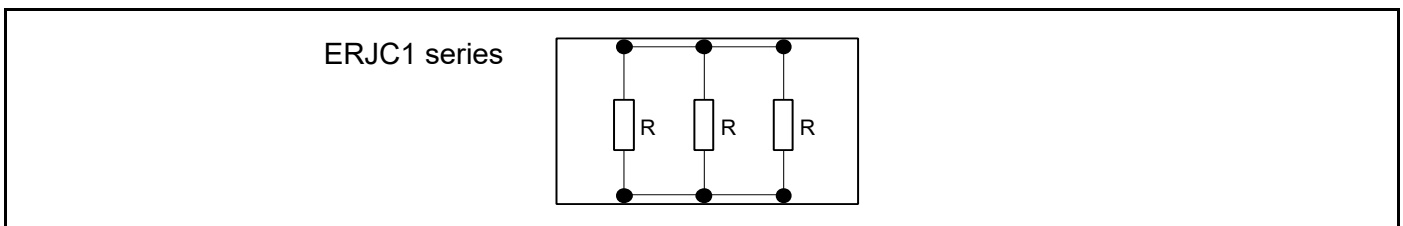

## Anti-Sulfurated High Power Chip Resistors (Wide Terminal Type)

Performance		
Test Item	Performance requirements $\Delta R$	Test conditions
Resistance	Within specified tolerance	20 °C
T. C. R.	Within specified T. C. R.	+25 °C / +125 °C
Overload	±2 %	Rated voltage × 2.0, 5 s
Resistance to soldering heat	±1 %	270 °C, 10 s
Rapid change of temperature	±2 %	-55 °C (30 min.) / +125 °C (30 min.), 1000 cycles
High temperature exposure	±1 %	+155 °C, 1000 h
Damp heat, Steady state	±1 %	60 °C, 90 % to 95 %RH, 1000 h
Load life in humidity	±3 %	60 °C, 90 % to 95 %RH, Rated voltage, 1.5 h ON / 0.5 h OFF cycle, 1000 h
Endurance at 70 °C	±3 %	70 °C, Rated voltage, 1.5 h ON / 0.5 h OFF cycle, 1000 h

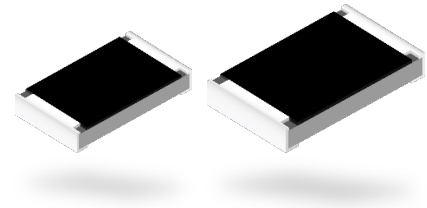

## High Temperature Thick Film Chip Resistor (Automotive Grade)

ERJH type

**ERJ H2G, H2C, H2R, H3G** series

**ERJ H3E, H3Q, H6G, HP6** series

### Features

- High reliability : Metal glaze thick film resistive element and high temperature of electrodes structure
- Achieve maximum category temperature 175 °C and rated category temperature 105 °C
- Compatible with placement machines : Taping packaging available
- Suitable for both reflow and flow soldering
- Reference standard : IEC 60115-8, JIS C 5201-8, JEITA RC-2134C
- AEC-Q200 compliant
- RoHS compliant

■ As for packaging methods, land pattern, soldering conditions and safety precautions, please see data files.

### Explanation of part numbers

Note : Please check the "Ratings" for the presence/absence of part numbers for combinations of the symbols below.

- ERJ H2G, H2C, H2R, H3G, H3E, H3Q, HP6 series :  $\pm 0.5\%$  ,  $\pm 1\%$  ,  $\pm 5\%$

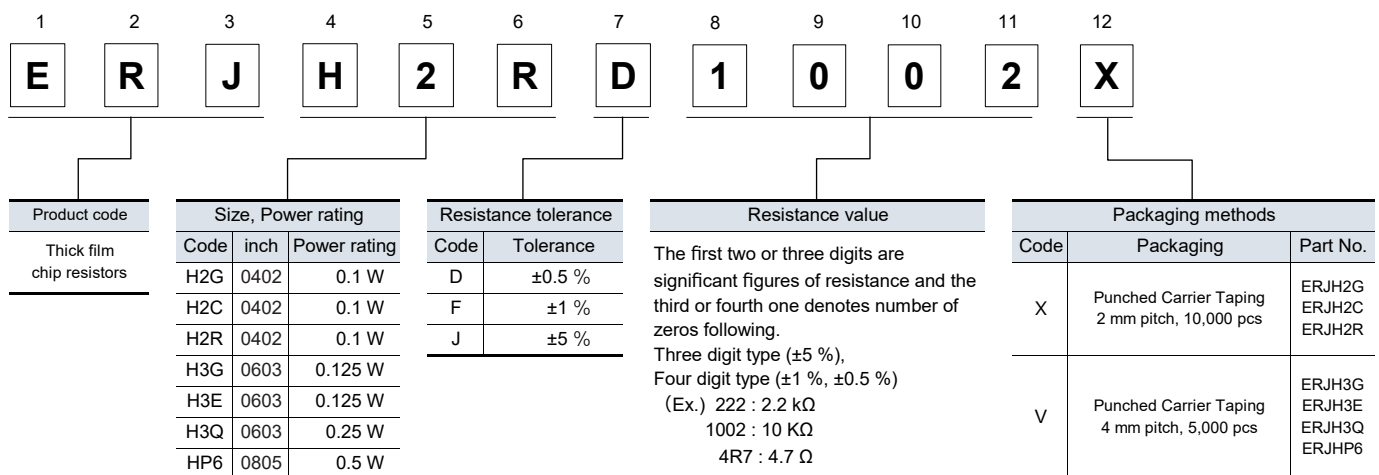

- ERJ H2G, H3G, H6G series : Jumper

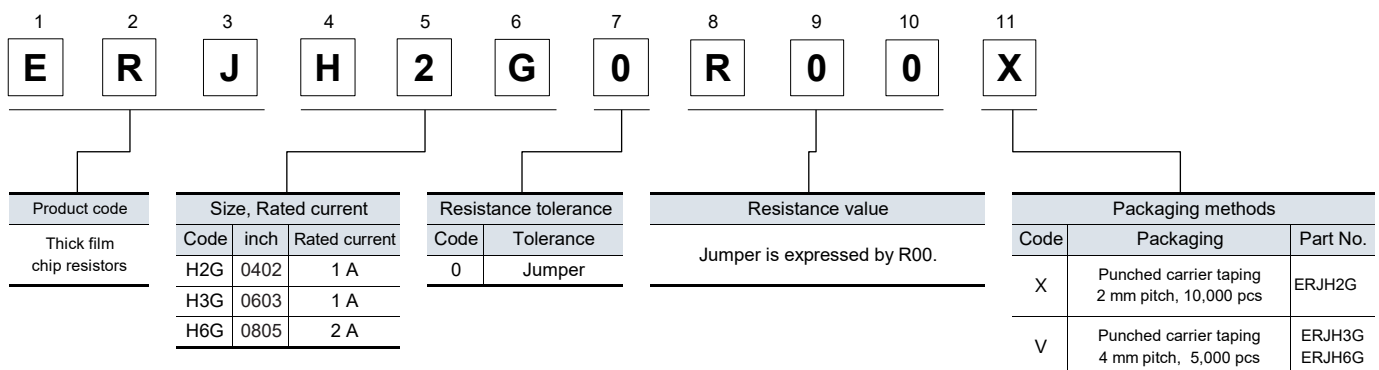



# High Temperature Thick Film Chip Resistor (Automotive Grade)

## Ratings

### [For Resistor]

Part No. (inch size)	Power rating*1 (105 °C) (W)	Limiting element voltage*2 (V)	Maximum overload voltage*3 (V)	Resistance tolerance (%)	Resistance range (Ω)	T.C.R. (×10 <sup>-6</sup> /K)	Category temperature range (°C)	AEC-Q200 Grade
ERJH2G (0402)	0.1	50	100	±5	1 to 300 k (E24)	R < 10Ω : -100 to +600 10Ω ≤ R : ±200	-55 to +175	Grade 0
ERJH2C (0402)	0.1	50	100	±1	1 to 9.76 (E24,E96)	-100 to +600		
ERJH2R (0402)	0.1	50	100	±0.5,±1	10 to 300 k (E24,E96)	±100		
ERJH3G (0603)	0.125	75	150	±5	1 to 300 k (E24)	R < 10Ω : -100 to +600 10Ω ≤ R : ±200		
ERJH3E (0603)	0.125	75	150	±0.5,±1	10 to 300 k (E24,E96)	±100		
ERJH3Q (0603)	0.25	-	-	±0.5,±1	1 to 9.76 (E24,E96)	±200		
				±5	1 to 9.1 (E24)			
ERJHP6 (0805)	0.5	400	600	±0.5	10 to 300 k (E24,E96)	R < 33Ω : ±300 33Ω ≤ R : ±100		
	0.5	400	600	±1	1 to 300 k (E24,E96)	R < 10Ω : -100 to +600 10Ω ≤ R < 33Ω : ±300 33Ω ≤ R : ±100		
	0.5	400	600	±5	1 to 300 k (E24)	R < 10Ω : -100 to +600 10Ω ≤ R < 33Ω : ±300 33Ω ≤ R : ±100		

\*1: Use it on the condition that the case temperature is below the upper category temperature.

\*2: Rated Continuous Working Voltage (RCWV) shall be determined from  $RCWV = \sqrt{\text{Power Rating} \times \text{Resistance Value}}$ , or Limiting Element Voltage listed above, whichever less.

\*3: Overload Test Voltage (OTV) shall be determined from  $OTV = \text{Specified Magnification (refer to performance)} \times RCWV$  or Maximum Overload Voltage listed above, whichever less.

### [For Jumper]

Part No. (inch size)	Resistance	Rated current	Maximum overload current*1
ERJH2G (0402)	50 mΩ or less	1 A	2 A
ERJH3G (0603)		1 A	2 A
ERJH6G (0805)		2 A	4 A

\*1: Overload test current

### Power derating curve

For resistors operated in ambient temperatures above 105 °C, power rating shall be derated in accordance with the figure below.

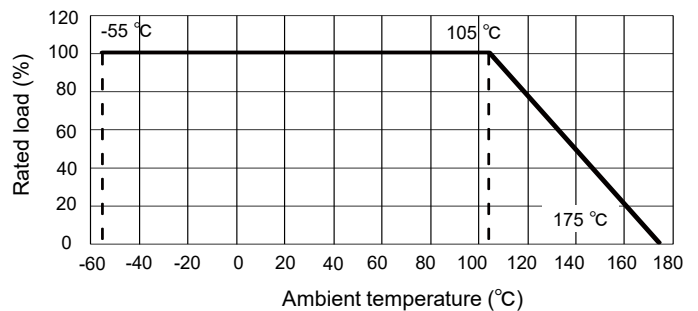

## Construction

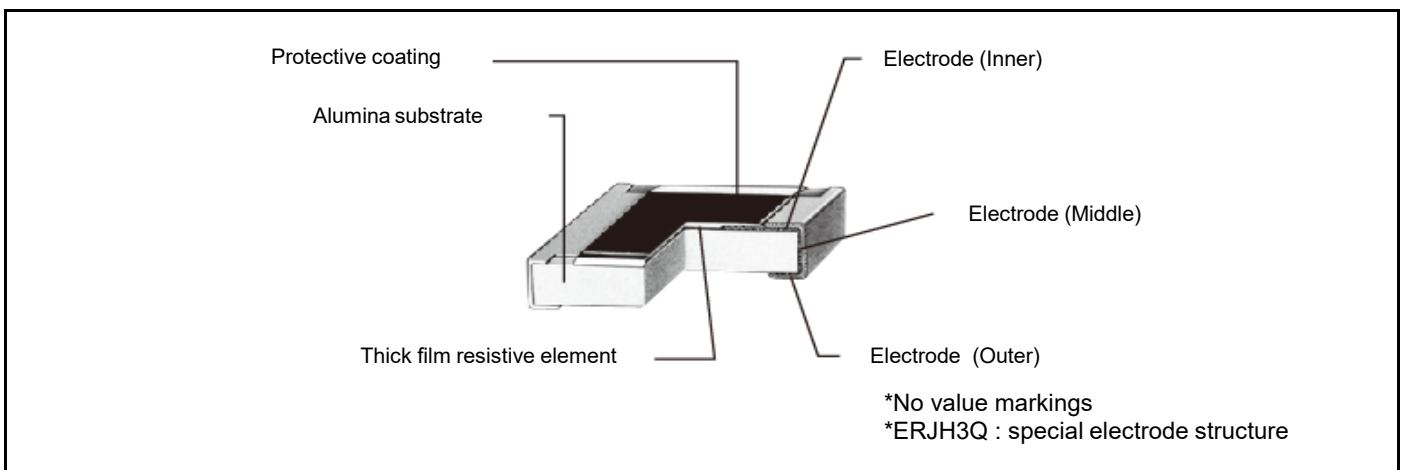

## High Temperature Thick Film Chip Resistor (Automotive Grade)

### Dimensions (not to scale)

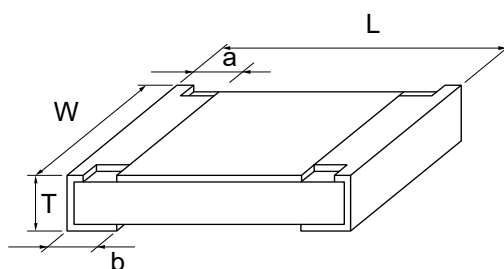

Unit : mm

Part No.	Dimensions					Mass (Weight) (Reference) (g/1000 pcs)
	L	W	a	b	T	
ERJH2G	1.00±0.05	0.50±0.05	0.20±0.10	0.25±0.05	0.35±0.05	0.8
ERJH2C	1.00±0.05	0.50±0.05	0.20±0.10	0.25±0.05	0.35±0.05	0.8
ERJH2R	1.00±0.05	0.50±0.05	0.20±0.10	0.25±0.05	0.35±0.05	0.8
ERJH3G	1.60±0.15	0.80+0.15/-0.05	0.30±0.20	0.30±0.15	0.45±0.10	2
ERJH3E	1.60±0.15	0.80+0.15/-0.05	0.30±0.20	0.30±0.15	0.45±0.10	2
ERJH3Q	1.60±0.15	0.80+0.15/-0.05	0.30±0.20	0.30±0.15	0.45±0.10	2
ERJH6G	2.00±0.20	1.25±0.10	0.40±0.20	0.40±0.20	0.60±0.10	4
ERJHP6	2.00±0.20	1.25±0.10	0.25±0.20	0.40±0.20	0.60±0.10	4

### Performance

Test item	Performance requirements $\Delta R$		Test conditions
	Resistor type	Jumper type	
Resistance	Within specified tolerance	50 m $\Omega$ or less	20 °C
T. C. R.	Within specified T. C. R.	50 m $\Omega$ or less	+25 °C / +175 °C
Overload	±2 %	50 m $\Omega$ or less	ERJH2G, H2C, H2R, H3G, H3E, H3Q : Rated voltage× 2.5, 5 s ERJHP6 : Rated voltage× 1.77, 5 s Jumper type : Max. overload current, 5 s
Resistance to soldering heat	±1 %	50 m $\Omega$ or less	270 °C, 10 s
Rapid change of temperature	±1 %	50 m $\Omega$ or less	-55 °C (30 min.) / +175 °C (30 min.), 1000 cycles
High temperature exposure	±1 %	50 m $\Omega$ or less	+175 °C, 1000 h
Damp heat, Steady state	±1 %	50 m $\Omega$ or less	85 °C, 85 %RH, 1000 h
Load life in humidity	±3 %	50 m $\Omega$ or less	85 °C, 85 %RH, Rated voltage (Jumper type : Rated current), 1.5 h ON / 0.5 h OFF cycle, 1000 h
Endurance at 105 °C	±3 %	50 m $\Omega$ or less	105 °C, Rated voltage (Jumper type : Rated current), 1.5 h ON / 0.5 h OFF cycle, 1000 h

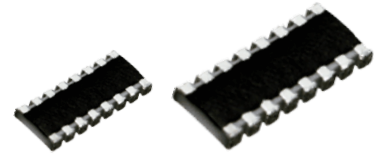

## Chip Resistors Array

EXB type

**EXB 14V, 18V, 24V, 28V, N8V, 2HV, series**

**EXB 34V, V4V, 38V, V8V, S8V series**

### Features

- High density
  - 2 resistors in 0.8 mm × 0.6 mm size / 0302 inch size : EXB14V
  - 4 resistors in 1.4 mm × 0.6 mm size / 0502 inch size : EXB18V
  - 2 resistors in 1.0 mm × 1.0 mm size / 0404 inch size : EXB24V
  - 4 resistors in 2.0 mm × 1.0 mm size / 0804 inch size : EXB28V, N8V
  - 8 resistors in 3.8 mm × 1.6 mm size / 1506 inch size : EXB2HV
  - 2 resistors in 1.6 mm × 1.6 mm size / 0606 inch size : EXB34V, V4V
  - 4 resistors in 3.2 mm × 1.6 mm size / 1206 inch size : EXB38V, V8V
  - 4 resistors in 5.1 mm × 2.2 mm size / 2009 inch size : EXBS8V
- Improvement of placement efficiency
  - Placement efficiency of Chip Resistor Array is two, four or eight times of the flat type chip resistor
- Reference Standard : IEC 60115-9, JIS C 5201-9, EIAJ RC-2129
- AEC-Q200 compliant (EXB2, EXB3)
- RoHS compliant

■ As for packaging methods, land pattern, soldering conditions and safety precautions, please see data files.

### Explanation of part numbers

Note : Please check the "Ratings" for the presence/absence of part numbers for combinations of the symbols below.

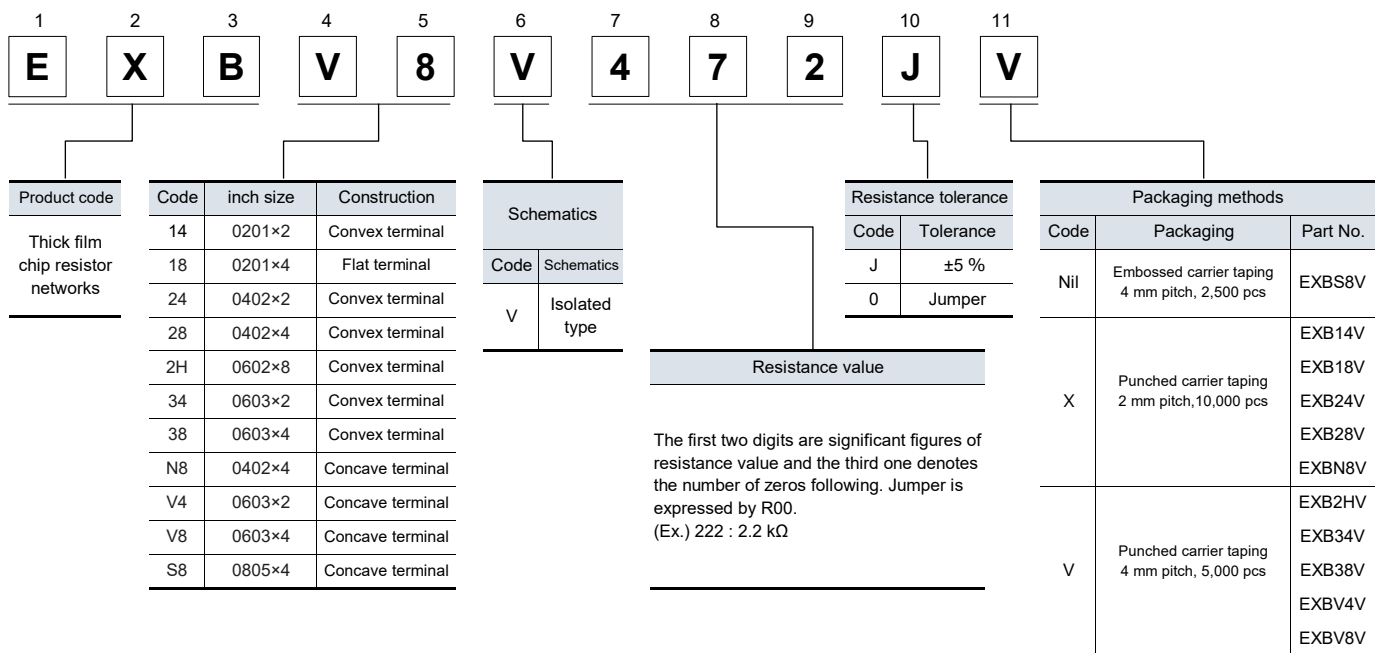

**Ratings**

**[For Resistor]**

Part No. (inch size)	Power rating (70 °C) (W/element)	Limiting element voltage <sup>-1</sup> (V)	Maximum overload voltage <sup>-2</sup> (V)	Resistance tolerance (%)	Resistance range (Ω)	T.C.R. (×10 <sup>-6</sup> /K)	Category temperature range (°C)	AEC-Q200 Grade
EXB14V (0201×2)	0.031	12.5	25	±5	10 to 1 M (E24)	R<10 Ω : -200 to +600  10 Ω to 1 MΩ : ±200	-55 to +125	-
EXB18V (0201×4)	0.031 (0.1 W / package)	12.5	25	±5	10 to 1 M (E24)			
EXB24V (0402×2)	0.063	50	100	±5	1 to 1 M (E24)			
EXB28V (0402×4)	0.063	50	100	±5	1 to 1 M (E24)			
EXB2HV (0602×8)	0.063 (0.25 W / package)	25	50	±5	10 to 1 M (E24)			Grade 1
EXB34V (0603×2)	0.063	50	100	±5	1 to 1 M (E24)			
EXB38V (0603×4)	0.063	50	100	±5	1 to 1 M (E24)			
EXBN8V (0402×4)	0.031	50	100	±5	10 to 1 M (E24)			
EXBV4V (0603×2)	0.063	50	100	±5	10 to 1 M (E24)			-
EXBV8V (0603×4)	0.063	50	100	±5	10 to 1 M (E24)			
EXBS8V (0805×4)	0.1	100	200	±5	10 to 1 M (E24)			

\*1: Rated Continuous Working Voltage (RCWV) shall be determined from  $RCWV = \sqrt{\text{Power Rating} \times \text{Resistance Value}}$ , or Limiting Element Voltage listed above, whichever less.

\*2: Overload Test Voltage (OTV) shall be determined from  $OTV = \text{Specified Magnification (refer to performance)} \times RCWV$  or Maximum Overload Voltage listed above, whichever less.

**[For Jumper]**

Part No.	Resistance	Rated current	Maximum overload current <sup>*1</sup>
EXB14V	50 mΩ or less	0.5 A	1 A
EXB18V		0.5 A	1 A
EXB24V		1 A	2 A
EXB28V		1 A	2 A
EXB2HV		1 A	2 A
EXB34V		1 A	2 A
EXB38V		1 A	2 A
EXBN8V		1 A	2 A
EXBV4V		1 A	2 A
EXBV8V		1 A	2 A
EXBS8V		2 A	4 A

\*1: Overload test current

**Power derating curve**

For resistors operated in ambient temperatures above 70 °C, power rating shall be derated in accordance with the figure below.

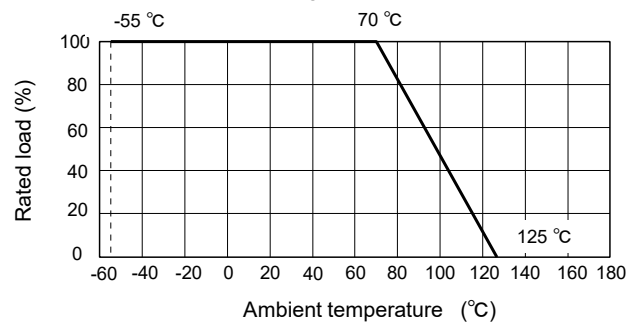

**Construction (Example : Concave terminal)**

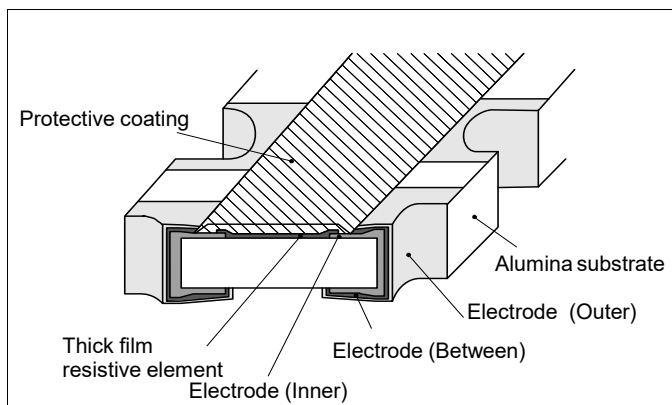

**Schematics**

● Isolated type

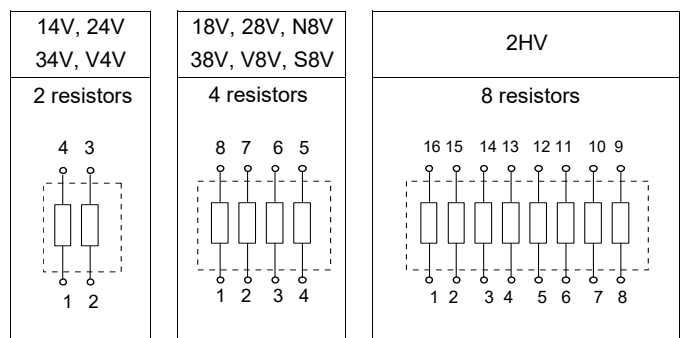

**Dimensions (not to scale)**

(1) Convex terminal type

EXB14V, 24V, 34V

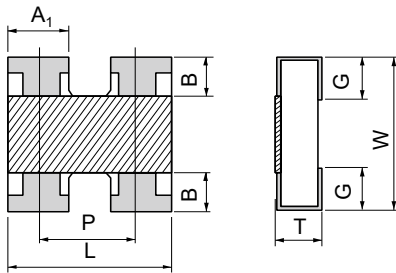

EXB28V, 38V

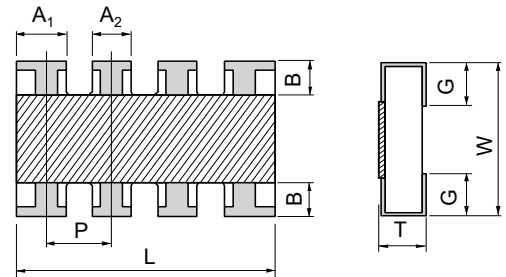

EXB2HV

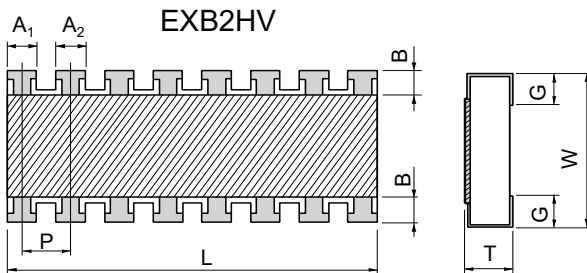

Unit : mm

Part No. (inch size)	Dimensions								Mass (Weight) (Reference) (g/1000 pcs)
	L	W	T	A <sub>1</sub>	A <sub>2</sub>	B	P	G	
EXB14V (0201×2)	0.80±0.10	0.60±0.10	0.35±0.10	0.35±0.10	—	0.15±0.10	(0.50)	0.15±0.10	0.5
EXB24V (0402×2)	1.00±0.10	1.00±0.10	0.35±0.10	0.40±0.10	—	0.18±0.10	(0.65)	0.25±0.10	1.2
EXB28V (0402×4)	2.00±0.10	1.00±0.10	0.35±0.10	0.45±0.10	0.35±0.10	0.20±0.10	(0.50)	0.25±0.10	2.0
EXB2HV (0602×8)	3.80±0.10	1.60±0.10	0.45±0.10	0.35±0.10	0.35±0.10	0.30±0.10	(0.50)	0.30±0.10	9.0
EXB34V (0603×2)	1.60±0.20	1.60±0.15	0.50±0.10	0.65±0.15	—	0.30±0.20	(0.80)	0.30±0.20	3.5
EXB38V (0603×4)	3.20±0.20	1.60±0.15	0.50±0.10	0.65±0.15	0.45±0.15	0.30±0.20	(0.80)	0.35±0.20	7.0

( ) Reference

(2) Concave terminal type

EXBV4V

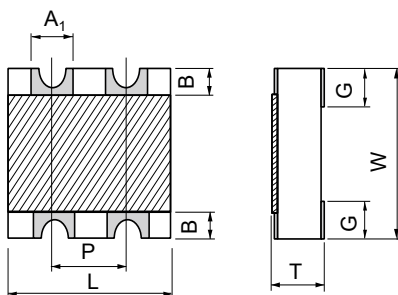

EXBN8V, V8V, S8V

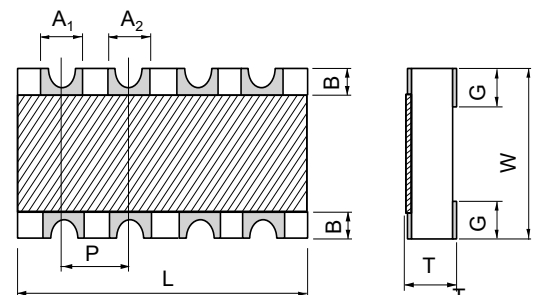

Unit : mm

Part No. (inch size)	Dimensions								Mass (Weight) (Reference) (g/1000 pcs)
	L	W	T	A <sub>1</sub>	A <sub>2</sub>	B	P	G	
EXBN8V (0402×4)	2.00±0.10	1.00±0.10	0.45±0.10	0.30±0.10	0.30±0.10	0.20±0.15	(0.50)	0.30±0.15	3.0
EXBV4V (0603×2)	1.60 +0.20/-0.10	1.60 +0.20/-0.10	0.60±0.10	0.60±0.10	—	0.30±0.15	(0.80)	0.45±0.15	5.0
EXBV8V (0603×4)	3.20 +0.20/-0.10	1.60 +0.20/-0.10	0.60±0.10	0.60±0.10	0.60±0.10	0.30±0.15	(0.80)	0.45±0.15	10
EXBS8V (0805×4)	5.08 +0.20/-0.10	2.20 +0.20/-0.10	0.70±0.20	0.80±0.15	0.80±0.15	0.50±0.15	(1.27)	0.55±0.15	30

( ) Reference

**Dimensions (not to scale)**

(3) Flat terminal type EXB18V

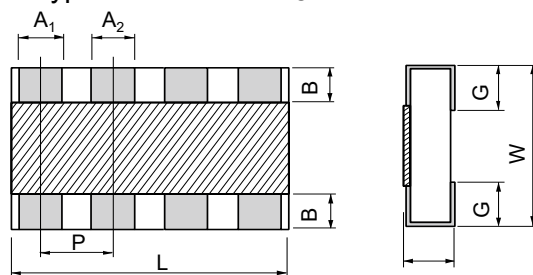

Unit : mm

Part No. (inch size)	Dimensions								Mass (Weight) (Reference) (g/1000 pcs)
	L	W	T	A <sub>1</sub>	A <sub>2</sub>	B	P	G	
EXB18V (0201×4)	1.40±0.10	0.60±0.10	0.35±0.10	0.20±0.10	0.20±0.10	0.10±0.10	(0.40)	0.20±0.10	1.0

( ) Reference

**Performance**

Test Item	Performance requirements ΔR	Test conditions
Resistance	Within specified tolerance	20 °C
T. C. R.	Within specified T. C. R.	+25 °C / +125 °C
Overload	±2 %	Rated voltage x 2.5, 5 s Jumper type : Max. overload current, 5 s
Resistance to soldering heat	±1 %	270 °C, 10 s
Rapid change of temperature	±1 %	-55 °C (30 min.) / +155 °C (30 min.), 100 cycles
High temperature exposure	±1 %	+125 °C, 1000 h
Damp heat, Steady state	±1 %	60 °C, 90 % to 95 %RH, 1000 h
Load life in humidity	±3 %	60 °C, 90 % to 95 %RH, Rated voltage (Jumper type : Rated current), 1.5 h ON / 0.5 h OFF cycle, 1000 h
Endurance at 70 °C	±3 %	70 °C, Rated voltage (Jumper type : Rated current), 1.5 h ON / 0.5 h OFF cycle, 1000 h

## Anti-Sulfurated Chip Resistors Array

EXB type

**EXB 14V, 18V, 24V, 28V, N8V, 2HV** series

**EXB 34V, V4V, 38V, V8V, S8V** series

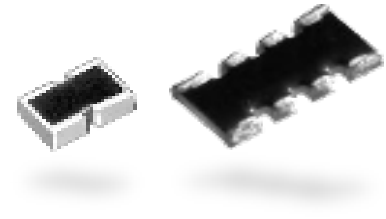

### Features

- High resistance to sulfurization achieved by adopting an Ag-Pd-based inner electrode
- High density
  - 2 resistors in 0.8 mm × 0.6 mm size / 0302 inch size : EXBU14
  - 4 resistors in 1.4 mm × 0.6 mm size / 0502 inch size : EXBU18
  - 2 resistors in 1.0 mm × 1.0 mm size / 0404 inch size : EXBU24
  - 4 resistors in 2.0 mm × 1.0 mm size / 0804 inch size : EXBU28
  - 8 resistors in 3.8 mm × 1.6 mm size / 1506 inch size : EXBU2H
  - 2 resistors in 1.6 mm × 1.6 mm size / 0606 inch size : EXBU34
  - 4 resistors in 3.2 mm × 1.6 mm size / 1206 inch size : EXBU38
- Improvement of placement efficiency  
Placement efficiency of chip resistor array is two, four or eight times of the flat type chip resistor
- Reference standard : IEC 60115-9, JIS C 5201-9, EIAJ RC-2129
- AEC-Q200 compliant (EXBU2, EXBU3)
- RoHS compliant

■ As for packaging methods, land pattern, soldering conditions and safety precautions, please see data files.

### Explanation of part numbers

Note : Please check the "Ratings" for the presence/absence of part numbers for combinations of the symbols below.

1	2	3	4	5	6	7	8	9	10	11	
E	X	B	U	2	8	4	7	2	J	X	
Product code	Code	inch size	Construction	Resistance value			Resistance tolerance		Packaging methods		
	Code	inch size	Construction	Resistance value			Code	Tolerance	Code	Packaging	Part No.
Thick film chip resistor networks	U14	0201×2	Convex terminal	The first two digits are significant figures of resistance value and the third one denotes the number of zeros following. Jumper is expressed by R00. (Ex.) 222 : 2.2 kΩ			J	±5 %	X	Punched carrier taping 2 mm pitch, 10,000 pcs	EXBU14
	U18	0201×4	Flat terminal				EXBU18				
	U24	0402×2	Convex terminal				EXBU24				
	U28	0402×4	Convex terminal				EXBU28				
	U2H	0602×8	Convex terminal				EXBU2H				
	U34	0603×2	Convex terminal				EXBU34				
U38	0603×4	Convex terminal	EXBU38	V	Punched carrier taping 4 mm pitch, 5,000 pcs	EXBU34 EXBU38					

## Ratings

### 【For Resistor】

Part No. (inch size)	Power rating (70 °C) (W/element)	Limiting element voltage <sup>*1</sup> (V)	Maximum overload voltage <sup>*2</sup> (V)	Resistance tolerance (%)	Resistance range (Ω)	T.C.R. (×10 <sup>-6</sup> /K)	Category temperature range (°C)	AEC-Q200 Grade
EXBU14 (0201×2)	0.031	12.5	25	±5	10 to 1 M (E24)	R<10 Ω : -200 to +600  10 Ω to 1 MΩ : ±200	-55 to +125	Grade 1
EXBU18 (0201×4)	0.031 (0.1 W / package)	12.5	25	±5	10 to 1 M (E24)			
EXBU24 (0402×2)	0.063	50	100	±5	1 to 1 M (E24)			
EXBU28 (0402×4)	0.063	50	100	±5	1 to 1 M (E24)			
EXBU2H (0602×8)	0.063 (0.25 W / package)	25	50	±5	10 to 1 M (E24)			
EXBU34 (0603×2)	0.063	50	100	±5	1 to 1 M (E24)			
EXBU38 (0603×4)	0.063	50	100	±5	1 to 1 M (E24)			

\*1: Rated Continuous Working Voltage (RCWV) shall be determined from  $RCWV = \sqrt{\text{Power Rating} \times \text{Resistance Value}}$ , or Limiting Element Voltage listed above, whichever less.

\*2: Overload Test Voltage (OTV) shall be determined from  $OTV = \text{Specified Magnification (refer to performance)} \times RCWV$  or Maximum Overload Voltage listed above, whichever less.

### 【For Jumper】

Part No.	Resistance	Rated current	Maximum overload current <sup>*1</sup>
EXBU24	100 mΩ or less	1 A	2 A
EXBU28			
EXBU2H			
EXBU34			
EXBU38			

\*1: Overload test current

### Power derating curve

For resistors operated in ambient temperatures above 70°C, power rating shall be derated in accordance with the figure below.

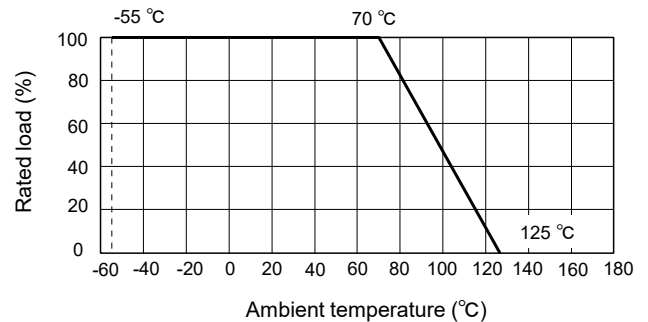

## Construction

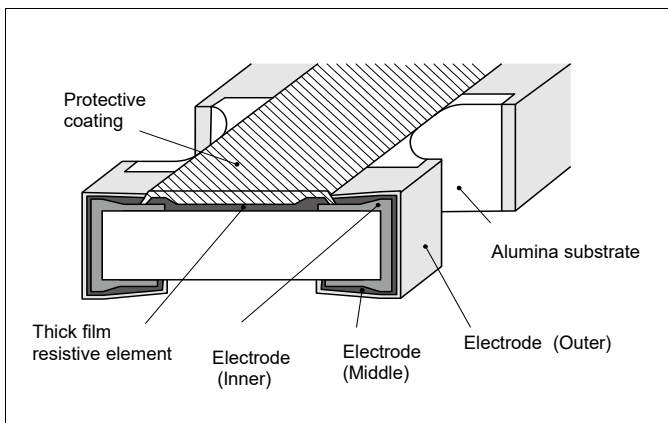

## Schematics

### ● Isolated type

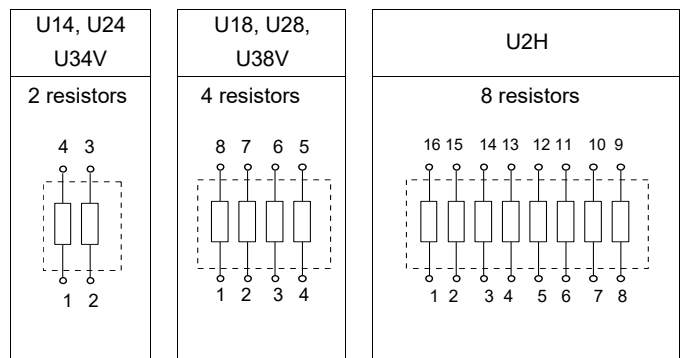



## Dimensions (not to scale)

EXBU14, U24, U34

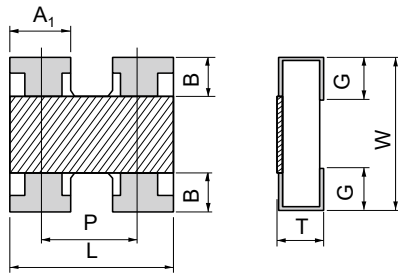

EXBU18

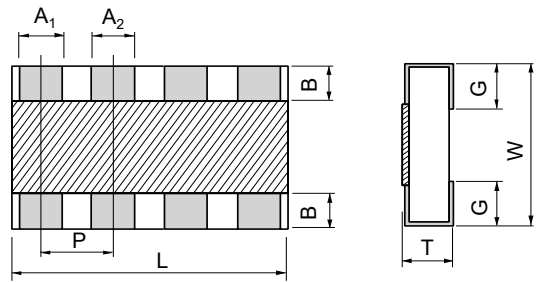

EXBU28, U38

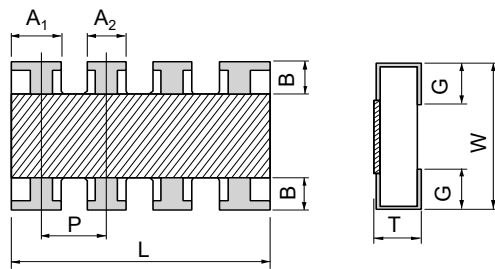

EXBU2H

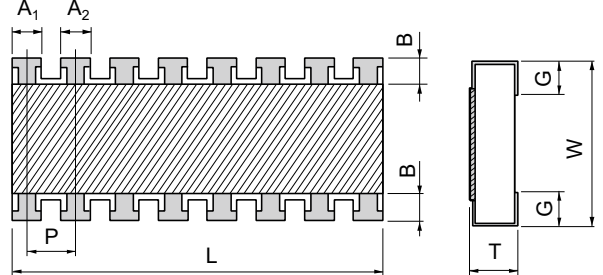

Unit : mm

Part No. (inch size)	Dimensions								Mass (Weight) (Reference) (g/1000 pcs)
	L	W	T	A <sub>1</sub>	A <sub>2</sub>	B	P	G	
EXBU14 (0201X2)	0.80±0.10	0.60±0.10	0.35±0.10	0.35±0.10	—	0.15±0.10	(0.50)	0.15±0.10	0.5
EXBU18 (0201×4)	1.40±0.10	0.60±0.10	0.35±0.10	0.20±0.10	0.20±0.10	0.10±0.10	(0.40)	0.20±0.10	1.0
EXBU24 (0402×2)	1.00±0.10	1.00±0.10	0.35±0.10	0.40±0.10	—	0.18±0.10	(0.65)	0.25±0.10	1.2
EXBU28 (0402×4)	2.00±0.10	1.00±0.10	0.35±0.10	0.45±0.10	0.35±0.10	0.20±0.10	(0.50)	0.25±0.10	2.0
EXBU2H (0602×8)	3.80±0.10	1.60±0.10	0.45±0.10	0.35±0.10	0.35±0.10	0.30±0.10	(0.50)	0.30±0.10	9.0
EXBU34 (0603×2)	1.60±0.20	1.60±0.15	0.50±0.10	0.65±0.15	—	0.30±0.20	(0.80)	0.30±0.20	3.5
EXBU38 (0603×4)	3.20±0.20	1.60±0.15	0.50±0.10	0.65±0.15	0.45±0.15	0.30±0.20	(0.80)	0.35±0.20	7.0

( ) Reference

## Performance

Test Item	Performance requirements ΔR	Test conditions
Resistance	Within specified tolerance	20 °C
T. C. R.	Within Specified T. C. R.	+25 °C / +125 °C
Overload	±2 %	Rated voltage x 2.5, 5 s Jumper type : Max. overload current, 5 s
Resistance to soldering heat	±1 %	270 °C, 10 s
Rapid change of temperature	±1 %	-55 °C (30 min.) / +125 °C (30 min.), 100 cycles
High temperature exposure	±1 %	+125 °C, 1000 h
Damp heat, Steady state	±1 %	60 °C, 90 % to 95 %RH, 1000 h
Load life in humidity	±3 %	60 °C, 90 % to 95 %RH, Rated voltage (Jumper type : Rated current), 1.5 h ON / 0.5 h OFF cycle, 1000 h
Endurance at 70 °C	±3 %	70 °C, Rated voltage (Jumper type : Rated current), 1.5 h ON / 0.5 h OFF cycle, 1000 h

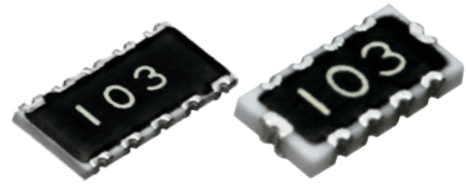

## Chip Resistors Networks

EXB type

EXB D, E, A, Q series

### Features

- High density placing for digital signal circuits
  - Bussed 8 or 15 resistors for pull up/down circuits
    - EXBD : 3.2 mm × 1.6 mm × 0.55 mm, 0.635 mm pitch
    - EXBE : 4.0 mm × 2.1 mm × 0.55 mm, 0.8 mm pitch
    - EXBA : 6.4 mm × 3.1 mm × 0.55 mm, 1.27 mm pitch
    - EXBQ : 3.8 mm × 1.6 mm × 0.45 mm, 0.5 mm pitch
  - Available direct placing on the bus line by means of half pitch spacing without through-holes on PWB ("High density placing" is shown below)
- High speed mounting using conventional placing machine
- Reference Standard : IEC 60115-9, JIS C 5201-9, EIAJ RC-2130
- RoHS compliant

#### 【 High density placing 】

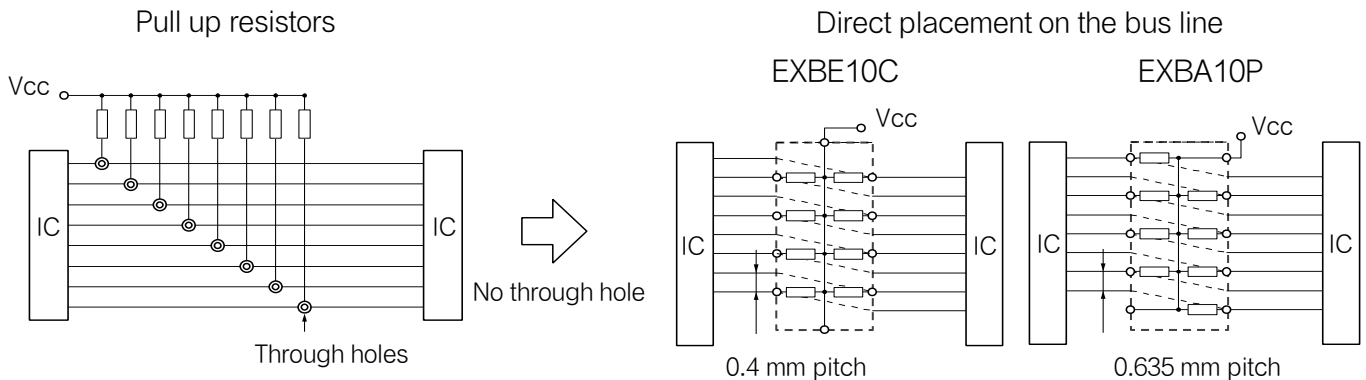

■ As for packaging methods, land pattern, soldering conditions and safety precautions, please see data files.

### Explanation of part numbers

Note : Please check the "Ratings" for the presence/absence of part numbers for combinations of the symbols below.

1	2	3	4	5	6	7	8	9	10	11	12
E	X	B	E	1	0	C	1	0	3	J	
Suffix for special requirements											
Product code Thick Film Resistor Networks	Dimension code of chip resistor network			Number of terminals 10 Terminals (EXBD, EXBE, EXBA) 16 Terminals (EXBQ)	Circuit configuration				Resistance value  The first two digits are significant figures of resistance value and the third one denotes the number of zeros following.	Resistance tolerance	
	Code	Inch	Dimensions (mm)		Code	Common terminal position				Code	Tolerance
	D	1206	3.2×1.6		C	Center common circuit (EXBD, EXBE)			J	±5 %	
	E	1608	4.0×2.1		P	Diagonal common circuit (Terminal 5 and Terminal 10) (EXBA)					
	A	2512	6.4×3.1		P	One side common circuit (Terminal 16) (EXBQ)					
	Q	1506	3.8×1.6		E	Diagonal common circuit (Terminal 1 and Terminal 6) (EXBA)					

**Ratings**

Part No. (inch size)	Resistance range (Ω)	Resistance tolerance (%)	Number of terminals	Number of resistors	Power rating <sup>*1</sup> (70 °C) (W/element)	Limiting element voltage <sup>*2</sup> (V)	Maximum overload voltage <sup>*3</sup> (V)	T.C.R. (×10 <sup>-6</sup> /K)	Category temperature range (°C)	AEC-Q200 Grade
EXBD (1206)	47 to 1 M (E12)	±5	10 terminals	8 element	0.05 / element	25	50	±200	-55 to +125	-
EXBE (1608)					0.063 / element	25	50	±200		
EXBA (2512)					0.063 / element	50	100	±200		
EXBQ (1506)	100 to 470 k (E6)	16 terminals	15 element	0.025 / element	25	50	±200			

\*1: Use it on the condition that the case temperature is below the upper category temperature.

\*2: Rated Continuous Working Voltage (RCWV) shall be determined from  $RCWV = \sqrt{\text{Power Rating} \times \text{Resistance Value}}$ , or Limiting Element Voltage listed above, whichever less.

\*3: Overload Test Voltage (OTV) shall be determined from  $OTV = \text{Specified Magnification (refer to performance)} \times RCWV$  or Maximum Overload Voltage listed above, whichever less.

**Power derating curve**

For resistors operated in ambient temperatures above 70 °C, power rating shall be derated in accordance with the figure on the right.

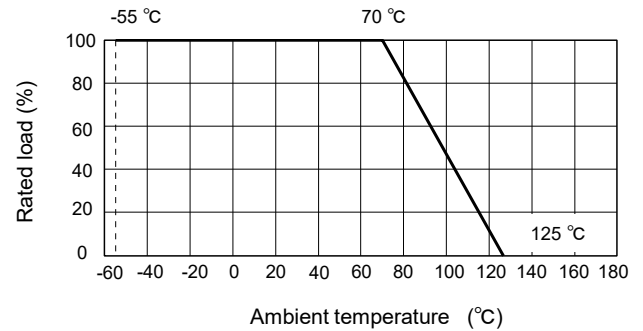

**Construction (Example : EXBD)**

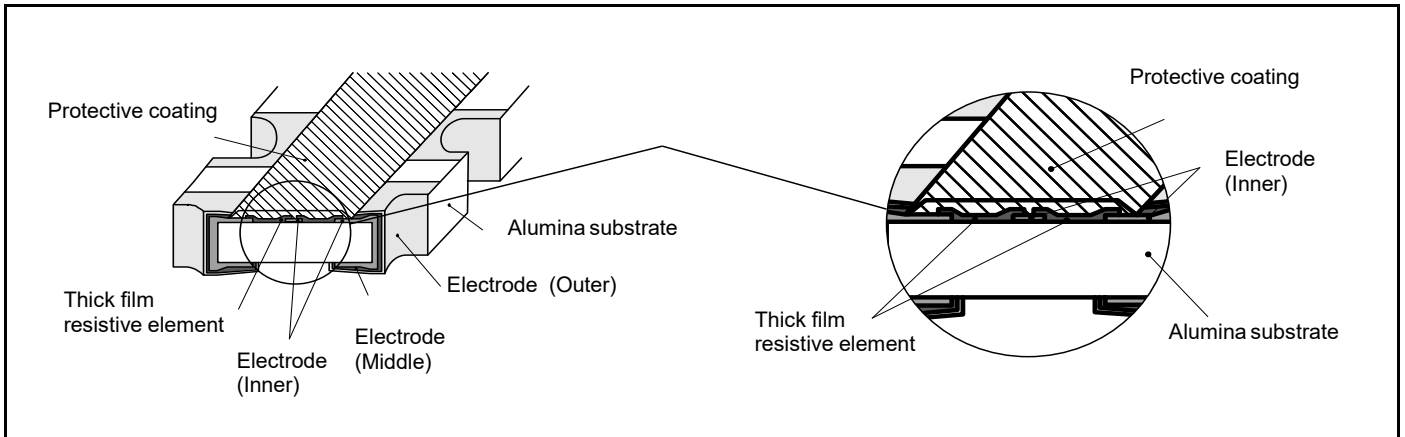

**Circuit configuration**

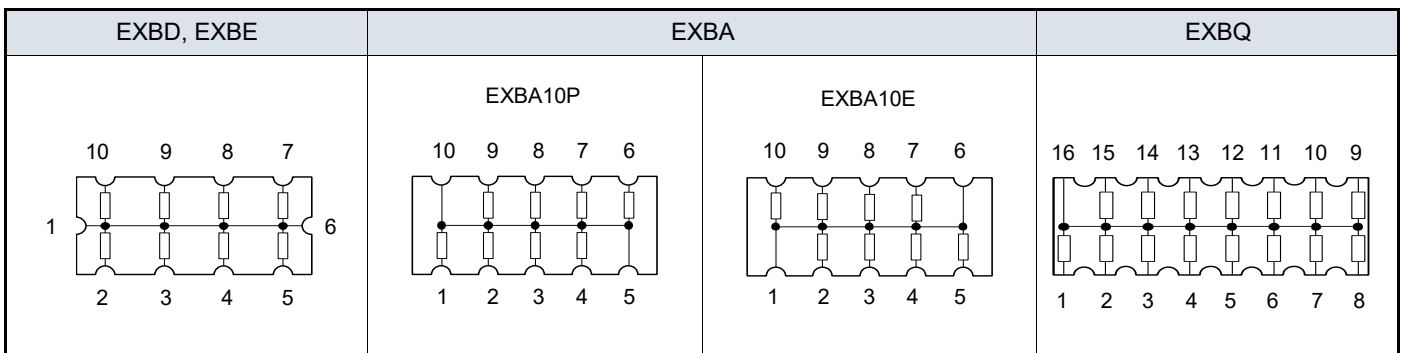

Dimensions (not to scale)

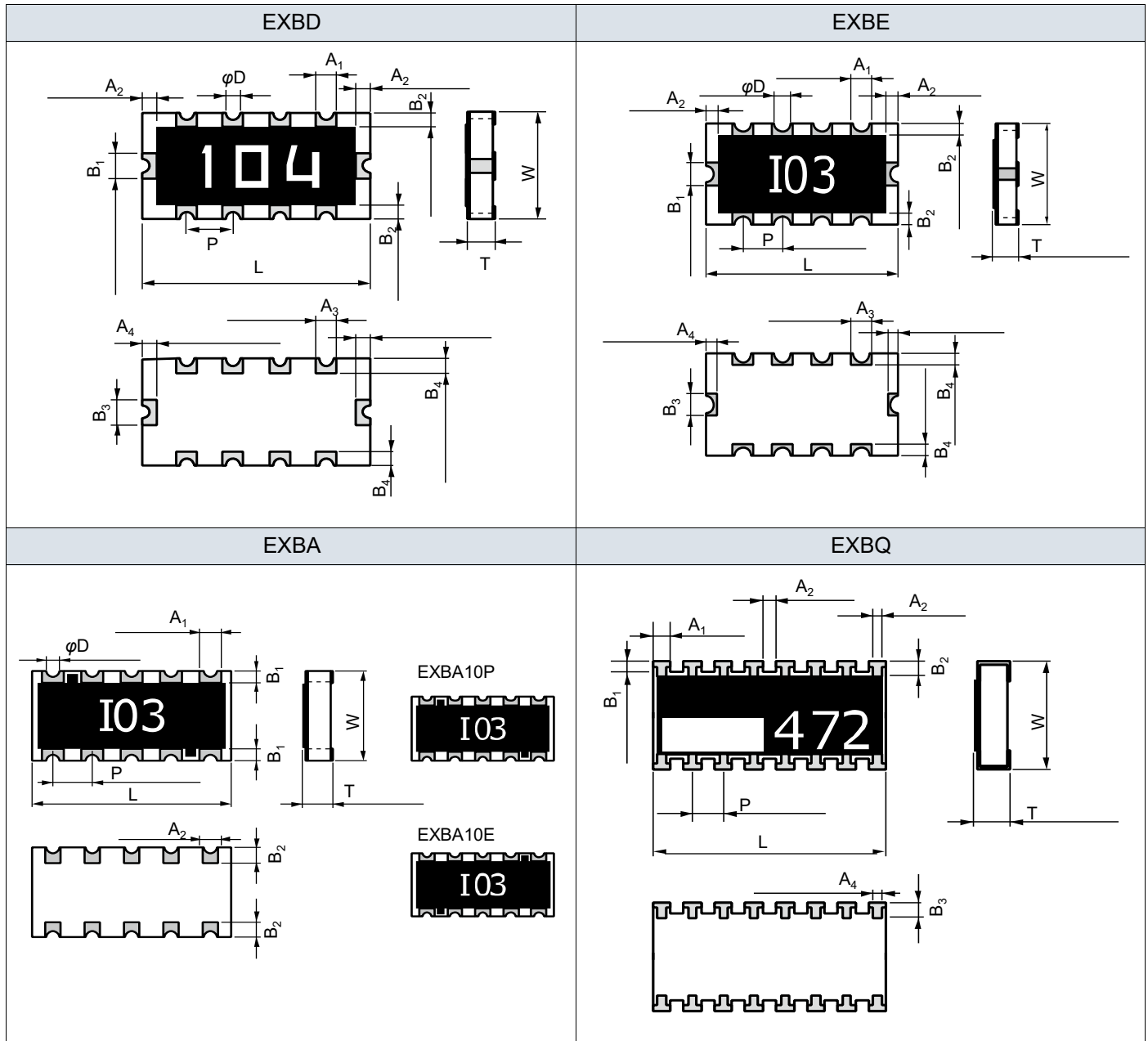

Unit : mm

Part No.	Dimensions							Mass (Weight) (Reference) (g/1000 pcs)
	L	W	T	A <sub>1</sub>	A <sub>2</sub>	B <sub>1</sub>	B <sub>2</sub>	
EXBD	3.20±0.15	1.60±0.15	0.55±0.10	0.33±0.15	0.2±0.1	0.40±0.15	0.2±0.1	10
	A <sub>3</sub>	A <sub>4</sub>	B <sub>3</sub>	B <sub>4</sub>	P	φD		
	0.3±0.1	0.25±0.10	0.40±0.15	0.35±0.15	0.635±0.10	0.2±0.1		
Part No.	Dimensions							Mass (Weight) (Reference) (g/1000 pcs)
	L	W	T	A <sub>1</sub>	A <sub>2</sub>	B <sub>1</sub>	B <sub>2</sub>	
	EXBE	4.0±0.2	2.1±0.2	0.55±0.10	0.5±0.2	0.3±0.2	0.5±0.2	0.25±0.20
A <sub>3</sub>		A <sub>4</sub>	B <sub>3</sub>	B <sub>4</sub>	P	φD		
0.4±0.2		0.35±0.20	0.5±0.2	0.4±0.2	0.8±0.1	0.3+0.1/-0.2		
Part No.	Dimensions							Mass (Weight) (Reference) (g/1000 pcs)
	L	W	T	A <sub>1</sub>	B <sub>1</sub>	A <sub>2</sub>	B <sub>2</sub>	
	EXBA	6.4±0.2	3.1±0.2	0.55±0.10	0.7±0.2	0.3±0.2	0.5±0.2	0.5±0.20
P		φD						
1.27±0.10		0.3+0.1/-0.2						
Part No.	Dimensions							Mass (Weight) (Reference) (g/1000 pcs)
	L	W	T	A <sub>1</sub>	A <sub>2</sub>	A <sub>3</sub>	B <sub>1</sub>	
	EXBQ	3.8±0.2	1.6±0.2	0.45±0.10	0.3±0.1	0.2±0.1	0.15+0.15/-0.05	0.15+0.15/-0.05
B <sub>2</sub>		A <sub>4</sub>	B <sub>3</sub>	P				
0.25±0.15		0.15+0.20/-0.05	0.30±0.15	0.5±0.1				

Design and specifications are each subject to change without notice. Ask factory for the current technical specifications before purchase and/or use. Should a safety concern arise regarding this product, please be sure to contact us immediately.

**Performance**

Test Item	Performance requirements $\Delta R$	Test conditions
Resistance	Within specified tolerance	20 °C
T. C. R.	Within specified T. C. R.	+25 °C / +125 °C
Overload	±3 %	Rated voltage x 2.5, 5 s
Resistance to soldering heat	±1 %	260 °C ±5 °C, 5 s ±1 s
Rapid change of temperature	±2 %	-55 °C (30 min.) / +125 °C (30 min.), 5 cycles
High temperature exposure	±3 %	+125 °C, 100 h
Load life in humidity	±3 %	60 °C±2 °C, 90 % to 95 %RH, Rated power × 0.1, 1.5 h ON / 0.5 h OFF cycle, 500 h
Endurance at 70 °C	±5 %	70 °C±2 °C, Rated voltage, 1.5 h ON / 0.5 h OFF cycle, 1000 h

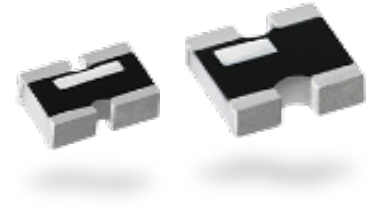

## Chip Attenuator

EXB type

EXB 14AT, 24AT series

### Features

- Unbalanced  $\pi$  type attenuator circuit in one chip  
EXB14AT (0.8 mm×0.6 mm) , EXB24AT (1.0 mm×1.0 mm)
- Reduced mounting area  
EXB14AT : About 60 % smaller than the area of an attenuator circuit consisting of three 0603 chip resistors, almost equal to the area of three 0402 chip resistors  
EXB24AT : About 50 % smaller than the area of an attenuator circuit consisting of three 1005 chip resistors, almost equal to the area of three 0603 chip resistors
- Mounting cost reduction : (Only 1 chip placed as compared to 3)
- Attenuation : 1 dB to 10 dB
- RoHS compliant

### Recommended applications

- Attenuation / level control / impedance matching of high frequency  
(communication signalling equipment cellular phones(GSM, CDMA, PDC, etc.), PHS, PDAs)
- As for packaging methods, land pattern, soldering conditions and safety precautions, please see data files.

### Explanation of part numbers

Note : Please check the "Ratings" for the presence/absence of part numbers for combinations of the symbols below.

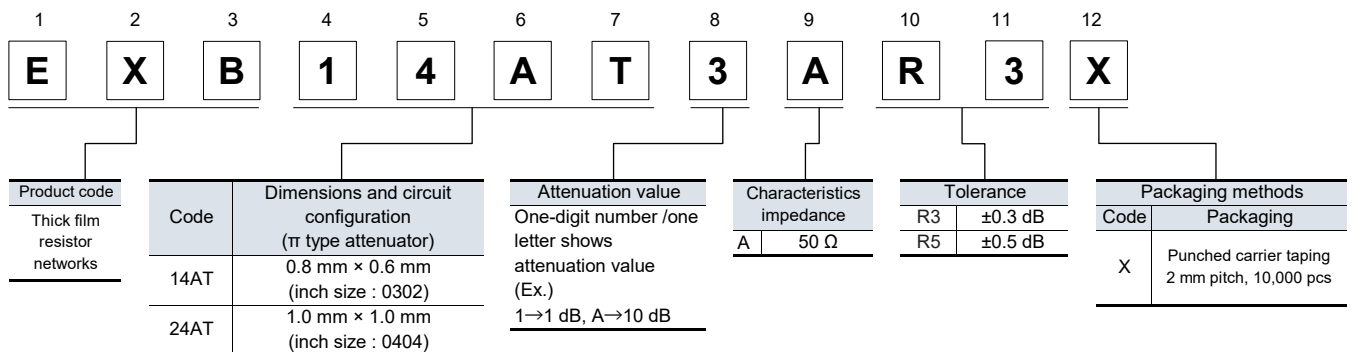

### Ratings

Part No.	EXB14AT, EXB24AT
Attenuation value	1 dB, 2 dB, 3 dB, 4 dB, 5 dB, 6 dB, 10 dB*
Attenuation value tolerance	1 dB, 2 dB, 3 dB, 4 dB, 5dB : $\pm 0.3$ dB 6 dB, 10 dB : $\pm 0.5$ dB
Characteristic impedance	50 $\Omega$
Power rating at 70 °C	0.04 W / package
Frequency range	DC to 3.0 GHz
VSWR (Voltage standing wave ratio)	1.3 max.
Number of resistors	3 resistors
Number of terminals	4 terminals
Category temperature range	-55 °C to +125 °C

\* Please inquire about the other Attenuator value

#### Power derating curve

For resistors operated in ambient temperatures above 70 °C, power rating shall be derated in accordance with the figure on the right.

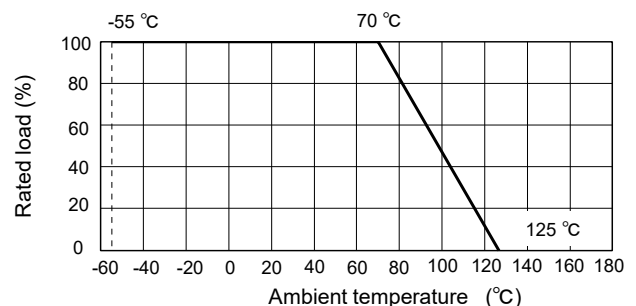

Construction

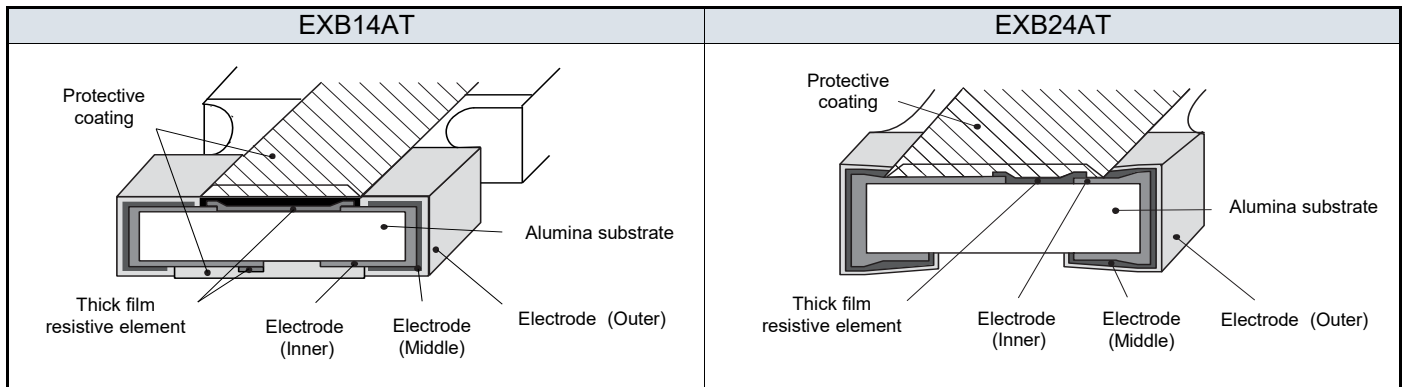

Circuit configuration

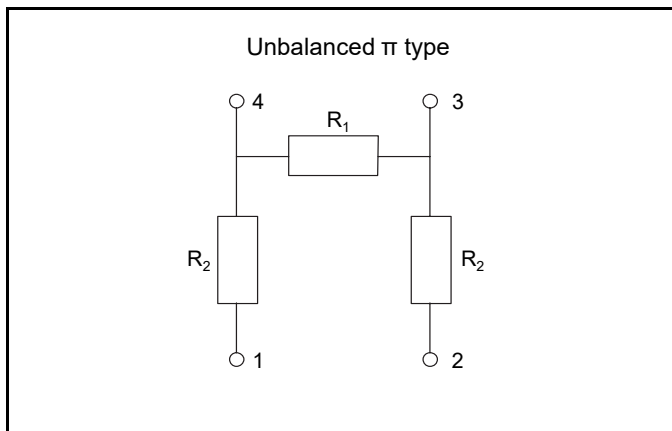

Attenuation-frequency characteristics

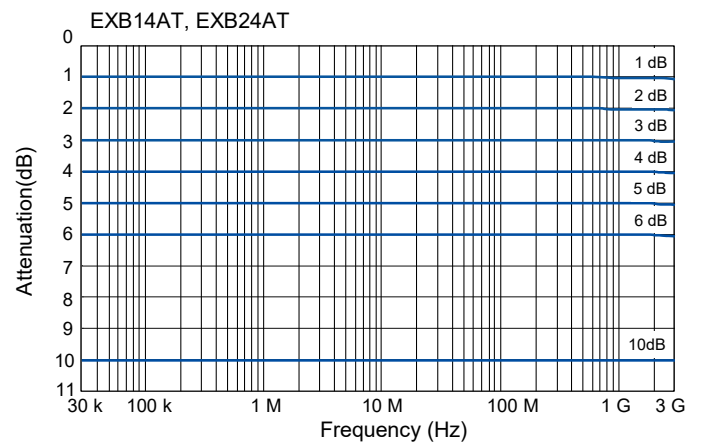

Dimensions (not to scale)

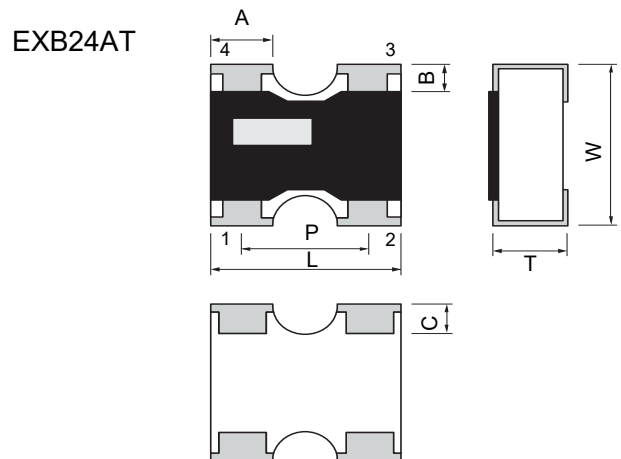
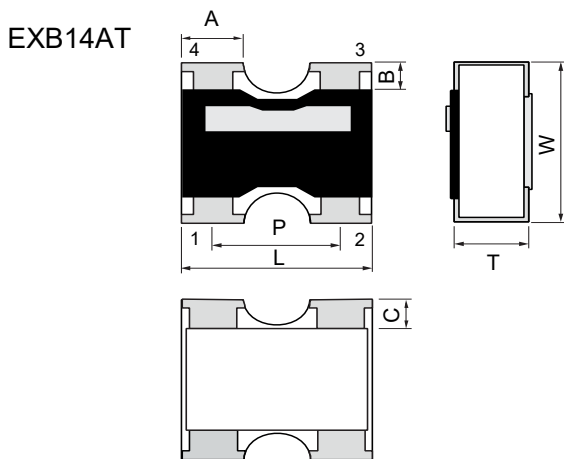

< Marking Configuration >  
The bar marking for recognizing terminal direction is located on the side of terminal 3, 4.

< Marking Configuration >  
The bar marking for recognizing terminal direction is located on the side of terminal 4.

Part No.	Dimensions							P (typical value)	Unit : mm
	L	W	T	A	B	C	Mass (Weight) (Reference) (g/1000 pcs)		
EXB14AT	0.80±0.10	0.60±0.10	0.35±0.10	0.35±0.10	0.15±0.10	0.15±0.10	0.50	0.7	
EXB24AT	1.00±0.10	1.00±0.10	0.35±0.10	0.40±0.10	0.15±0.10	0.25±0.10	0.65	1.1	

## Packaging method

Surface mount resistors series			Packaging (Standard quantity : pcs/reel)			
Products	Part No.	Size (mm) (inch)	Pressed carrier taping (2 mm pitch )	Punched carrier taping (2 mm pitch )	Punched carrier taping (4 mm pitch )	Embossed carrier taping (4 mm pitch )
Thick film chip resistors	ERJXGN	0402 (01005)	20,000 <sup>*1</sup>	—	—	40,000 <sup>*2</sup>
	ERJ1GN	0603 (0201)	15,000	—	—	—
	ERJ2GE	1005 (0402)	—	10,000	—	—
	ERJ3GE	1608 (0603)	—	—	5,000	—
	ERJ6GE	2012 (0805)	—	—	5,000	—
	ERJ8GE	3216 (1206)	—	—	5,000	—
	ERJ14	3225 (1210)	—	—	—	5,000
	ERJ12	4532 (1812)	—	—	—	5,000
	ERJ12Z	5025 (2010)	—	—	—	5,000
	ERJ1T	6432 (2512)	—	—	—	4,000
Precision thick film chip resistors	ERJXGN	0402 (01005)	20,000 <sup>*1</sup>	—	—	40,000 <sup>*2</sup>
	ERJ1GN/1RH	0603 (0201)	15,000	—	—	—
	ERJ2RC/2RH/2RK	1005 (0402)	—	10,000	—	—
	ERJ3RB/3RE/3EK	1608 (0603)	—	—	5,000	—
	ERJ6RB/6RE/6EN	2012 (0805)	—	—	5,000	—
	ERJ8EN	3216 (1206)	—	—	5,000	—
	ERJ14N	3225 (1210)	—	—	—	5,000
	ERJ12N	4532 (1812)	—	—	—	5,000
	ERJ12S	5025 (2010)	—	—	—	5,000
	ERJ1TN	6432 (2512)	—	—	—	4,000
Metal film (Thin film) chip resistors, High reliability type	ERA1A	0603 (0201)	15,000	—	—	—
	ERA2A/2V	1005 (0402)	—	10,000	—	—
	ERA3A/3V/3K	1608 (0603)	—	—	5,000	—
	ERA6A/6V/6K	2012 (0805)	—	—	5,000	—
	ERA8A/8V/8K/8P	3216 (1206)	—	—	5,000	—
Thick film chip resistors/ Low resistance type	ERJ2LW/2BW	1005 (0402)	10,000	—	—	—
	ERJ2BS/2BQ	1005 (0402)	—	10,000	—	—
	ERJ3L/3B/3R/L03	1608 (0603)	—	—	5,000	—
	ERJ6L/6B/6C ERJ6D/6R/L06	2012 (0805)	—	—	5,000	—
	ERJ8B/8C/8R/L08	3216 (1206)	—	—	5,000	—
	ERJ14B/14R/L14	3225 (1210)	—	—	—	5,000
	ERJ12R/L12	4532 (1812)	—	—	—	5,000
	ERJ12Z/L1D	5025 (2010)	—	—	—	5,000
	ERJ1TR	6432 (2512)	—	—	—	4,000
Current sensing resistors, Metal plate type	ERJMS4	6432 (2512)	—	—	—	2,000
	ERJMB1	2550 (1020)	—	—	—	3,000
High power chip resistors/ Wide terminal type	ERJA1	3264 (1225)	—	—	—	4,000
	ERJB1/ERJC1 <sup>*3</sup> ERJD1 <sup>*4</sup>	2550 (1020)	—	—	—	5,000
	ERJB2/ERJD2 <sup>*4</sup>	1632 (0612)	—	—	5,000	—
	ERJB3	1220 (0508)	—	—	5,000	—
High precision thick film chip resistors	ERJPB3	1608 (0603)	—	—	5,000	—
	ERJPB6	2012 (0805)	—	—	5,000	—

\*1: W8P2 : Width 8 mm, Pitch 2 mm,

\*3: Anti-Sulfurated High power chip resistors / Wide terminal type

\*2: W4P1 : Width 4 mm, Pitch 1 mm

\*4: Low TCR High power chip Resistors / Wide terminal type



## Packaging method

Surface mount resistors series			Packaging (Standard quantity : pcs/reel)				
Products	Part No.	Size (mm) (inch)	Pressed carrier taping (2 mm pitch)	Punched carrier taping (2 mm pitch)	Punched carrier taping (4 mm pitch)	Embossed carrier taping (4 mm pitch)	
Anti-Surge Thick film chip resistors	ERJPA2	1005 (0402)	—	10,000	—	—	
	ERJP03/PA3	1608 (0603)	—	—	5,000	—	
	ERJP06/P6W	2012 (0805)	—	—	5,000	—	
	ERJP08/PM8	3216 (1206)	—	—	5,000	—	
	ERJP14	3225 (1210)	—	—	—	5,000	
Anti-Pulse Thick film chip resistors	ERJT06	2012 (0805)	—	—	5,000	—	
	ERJT08	3216 (1206)	—	—	5,000	—	
	ERJT14	3225 (1210)	—	—	—	5,000	
Anti-Sulfurated Thick film chip resistors	ERJU0X	0402 (01005)	20,000	—	—	—	
	ERJU01	0603 (0201)	15,000	—	—	—	
	ERJS02/U02	1005 (0402)	—	10,000	—	—	
	ERJS03/U03	1608 (0603)	—	—	5,000	—	
	ERJS06/U06 ERJU6S/U6Q	2012 (0805)	—	—	5,000	—	
	ERJS08/U08	3216 (1206)	—	—	5,000	—	
	ERJS14/U14	3225 (1210)	—	—	—	5,000	
	ERJS12/U12	4532 (1812)	—	—	—	5,000	
	ERJS1D/U1D ERJS1T/U1T	5025 (2010) 6432 (2512)	—	—	—	5,000 4,000	
Anti-Sulfurated Thick film chip resistors / Precision type	ERJU2R	1005 (0402)	—	10,000	—	—	
	ERJU3R	1608 (0603)	—	—	5,000	—	
	ERJU6R	2012 (0805)	—	—	5,000	—	
Anti-Sulfurated Thick film chip resistors / Anti-Surge type	ERJUP3	1608 (0603)	—	—	5,000	—	
	ERJUP6	2012 (0805)	—	—	5,000	—	
	ERJUP8	3216 (1206)	—	—	5,000	—	
High temperature thick film chip resistor	ERJH2G/2C/2R	1005 (0402)	—	10,000	—	—	
	ERJH3G/3E/3Q	1608 (0603)	—	—	5,000	—	
	ERJH6G/HP6	2012 (0805)	—	—	5,000	—	
Chip resistor array	EXB14V	0806 (0302)	—	10,000	—	—	
	EXB24V	1010 (0404)	—	10,000	—	—	
	EXB34V	1616 (0606)	—	—	5,000	—	
	EXBV4V	1616 (0606)	—	—	5,000	—	
	EXB18V	1406 (0502)	—	10,000	—	—	
	EXB28V	2010 (0804)	—	10,000	—	—	
	EXBN8V	2010 (0804)	—	10,000	—	—	
	EXB38V	3216 (1206)	—	—	5,000	—	
	EXBV8V	3216 (1206)	—	—	5,000	—	
	EXBS8V	5022 (2009)	—	—	—	2,500	
Anti-Sulfurated chip resistor array	EXBU14	0806 (0302)	—	10,000	—	—	
	EXBU18	1406 (0502)	—	10,000	—	—	
	EXBU24	1010 (0404)	—	10,000	—	—	
	EXBU34	1616 (0606)	—	—	5,000	—	
	EXBU28	2010 (0804)	—	10,000	—	—	
	EXBU38	3216 (1206)	—	—	5,000	—	
	EXBU2H	3816 (1506)	—	—	5,000	—	
	Chip resistor networks	EXBD	3216 (1206)	—	—	5,000	—
		EXBE	4021 (1608)	—	—	—	4,000
		EXBA	6431 (2512)	—	—	—	4,000
EXBQ		3816 (1506)	—	—	5,000	—	
Chip attenuator	EXB14AT	0806 (0302)	—	10,000	—	—	
	EXB24AT	1010 (0404)	—	10,000	—	—	

**Carrier tape**

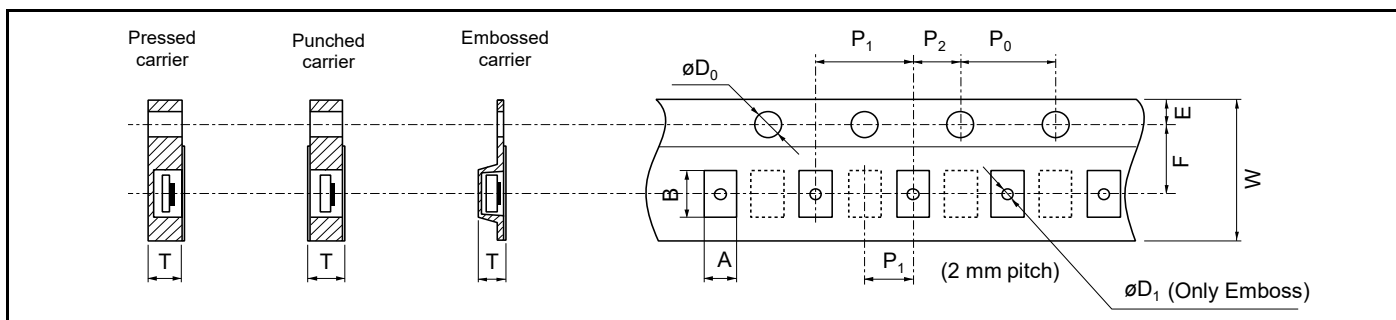

**Pressed carrier taping (2 mm Pitch)**

● Chip resistors / Precision chip / Metal film(Thin film)chip / Low resistance / Anti-Sulfurated Unit : mm

Part No.	Size (inch)	A	B	W	F	E	P <sub>1</sub>	P <sub>2</sub>	P <sub>0</sub>	øD <sub>0</sub>	T
ERJXGN ERJU0X	0402 (01005)	0.24±0.03	0.45±0.03	8.00±0.20	3.50±0.05	1.75±0.10	2.00±0.10	2.00±0.05	4.00±0.10	1.50 +0.10/0	0.31±0.05
ERJ1GN ERJ1R□ ERJU01 ERA1A	0603 (0201)	0.38±0.05	0.68±0.05								0.42±0.05
ERJ2LW ERJ2BW	1005 (0402)	0.68±0.10 0.67±0.10	1.20±0.10 1.17±0.10								0.60±0.05 0.61±0.05

**Punched carrier taping (2 mm Pitch)**

● Chip resistors / Precision chip / Thin film chip / Low resistance / Anti-Surge / Anti-Sulfur / High temperature / Metal foil type Unit : mm

Part No.	Size (inch)	A	B	W	F	E	P <sub>1</sub>	P <sub>2</sub>	P <sub>0</sub>	øD <sub>0</sub>	T
ERJ2□ ERJPA2 ERJ□□2 ERJ□2□ ERA2□	1005 (0402)	0.67±0.05	1.17±0.05	8.00±0.20	3.50±0.05	1.75±0.10	2.00±0.10	2.00±0.05	4.00±0.10	1.50 +0.10/0	0.52±0.05

● Chip resistor array / Anti-Sulfurated chip resistor Aarray / Chip attenuator Unit : mm

Part No.	Size (inch)	A	B	W	F	E	P <sub>1</sub>	P <sub>2</sub>	P <sub>0</sub>	øD <sub>0</sub>	T
EXB14V EXB14AT	0806 (0302)	0.70 +0.10/-0.05	0.95 +0.05/-0.10	8.00±0.20	3.50±0.05	1.75±0.10	2.00±0.10	2.00±0.05	4.00±0.10	1.50 +0.10/0	0.52±0.05
EXB18V	1406 (0502)	1.20±0.10	1.60±0.10								
EXB24V EXBU24 EXB24AT	1010 (0404)		1.20±0.10								
EXB28V EXBU28 EXBN8V	2010 (0804)	1.20±0.10	2.20±0.10								

**Punched carrier taping (4 mm Pitch)**

● Chip resistors / Precision chip / Metal film(Thin film)chip / Low resistance / High power / High precision / Anti-Surge / Anti-Pulse / Anti-Sulfurated / High temperature Unit : mm

Part No.	Size (inch)	A	B	W	F	E	P <sub>1</sub>	P <sub>2</sub>	P <sub>0</sub>	øD <sub>0</sub>	T
ERJ3□ ERJ3LW(10mΩ) ERJ3BW ERJ□□3 ERJ□3□ ERA3□ ERJ3LW(5mΩ)	1608 (0603)	1.10±0.10	1.90±0.10	8.00±0.20	3.50±0.05	1.75±0.10	4.00±0.10	2.00±0.05	4.00±0.10	1.50 +0.10/0	0.70±0.05
ERJ6□ ERJ□□6 ERJ□6□ ERA6□	2012 (0805)	1.65±0.15	2.50±0.20								0.84±0.05
ERJB3 ERJ6BW ERJ6LW ERJ6CW	1220 (0508) 2012 (0805)	1.55±0.15	2.30±0.20								0.94±0.05
ERJ8□ ERJ8□W ERJ□□8 ERA8□ ERJB2 ERJD2	3216 (1206) 1632 (0612)	2.00±0.15	3.60±0.20	8.00±0.20	3.50±0.05	1.75±0.10	4.00±0.10	2.00±0.05	4.00±0.10	1.50 +0.10/0	0.84±0.05

**Punched carrier taping (4 mm Pitch)**

● Chip resistor array / Anti-Sulfurated chip resistor array / Chip resistor networks

Unit : mm

Part No.	Size (inch)	A	B	W	F	E	P <sub>1</sub>	P <sub>2</sub>	P <sub>0</sub>	øD <sub>0</sub>	T	
EXB34V EXBU34	1616 (0606)	1.95±0.15	1.95±0.20	8.00±0.20	3.50±0.05	1.75±0.10	4.00±0.10	2.00±0.05	4.00±0.10	1.50 +0.10/0	0.70±0.05	
EXB38V EXBU38	3216 (1206)		3.60±0.20									0.84±0.05
EXB2HV EXBU2H	3816 (1506)		4.10±0.15									
EXBV4V	1616 (0606)		1.95±0.20								0.84±0.10	
EXBV8V	3216 (1206)		3.60±0.20									
EXBD	3216 (1206)		2.00±0.20								3.60±0.20	0.84±0.10
EXBQ	3816 (1506)	1.90±0.20	4.10±0.20	0.64±0.05								

**Embossed carrier taping (1 mm Pitch)**

● Chip resistors

Unit : mm

Part No.	Size (inch)	A	B	W	F	E	P <sub>1</sub>	P <sub>2</sub>	P <sub>0</sub>	øD <sub>0</sub>	T
ERJXGN	0402 (01005)	0.25±0.05	0.45±0.05	4.00±0.20	1.80±0.05	0.90±0.10	1.00±0.10	1.00±0.10	2.00±0.10	0.80±0.10	0.5 max.

**Embossed carrier taping (4 mm Pitch)**

● Chip resistors / Precision chip / Low resistance / High power / Anti-Surge / Anti-Pulse / Anti-Sulfurated

Unit : mm

Part No.	Size (inch)	A	B	W	F	E	P <sub>1</sub>	P <sub>2</sub>	P <sub>0</sub>	øD <sub>0</sub>	T	øD <sub>1</sub>	
ERJ14□ ERJ□14	3225 (1210)	2.80±0.20	3.50±0.20	8.00±0.30	3.50±0.05	1.75 ±0.10	4.00 ±0.10	2.00 ±0.05	4.00 ±0.10	1.50 +0.10/0	1.00±0.10	1.00±0.10/0	
ERJ12□ ERJ□12	4532 (1812)	3.50±0.20	4.80±0.20	12.00 ±0.30	5.50±0.20							1.5 min.	
ERJ12Z ERJ12S ERJ□1D	5025 (2010)	2.80±0.20	5.30±0.20										
ERJB1 ERJC1 ERJD1	2550 (1020)												
ERJ1T□ ERJ□1T	6432 (2512)												3.60±0.20
ERJL1W		1.60±0.10											
ERJA1	3264 (1225)	3.50±0.20	6.80±0.20										1.10±0.20

● Current sensing resistors, Metal plate type

Unit : mm

Part No.	Size (inch)	A	B	W	F	E	P <sub>1</sub>	P <sub>2</sub>	P <sub>0</sub>	øD <sub>0</sub>	T	øD <sub>1</sub>
ERJMB1	2550 (1020)	2.90±0.20	5.40±0.20	12.00 ±0.30	5.50±0.10	1.75 ±0.10	4.00 ±0.10	2.00 ±0.05	4.00 ±0.10	1.50 +0.10/0	1.55±0.20	—
ERJMS4	6432 (2512)	3.50±0.20	6.90±0.20	12.00 ±0.30	5.50±0.10						1.60±0.20	1.5 min.

● Chip resistor array / Chip resistor networks

Unit : mm

Part No.	Size (inch)	A	B	W	F	E	P <sub>1</sub>	P <sub>2</sub>	P <sub>0</sub>	øD <sub>0</sub>	T	øD <sub>1</sub>
EXBS8V	5022 (2009)	2.80±0.20	5.70±0.20	12.00±0.30	5.50±0.20	1.75 ±0.10	4.00 ±0.10	2.00 ±0.05	4.00 ±0.10	1.50 +0.10/0	1.6 max.	1.5 min.
EXBE	4021 (1608)	2.50±0.20	4.40±0.20									
EXBA	6431 (2512)	3.50±0.20	6.80±0.20								1.10±0.20	

**Taping reel**

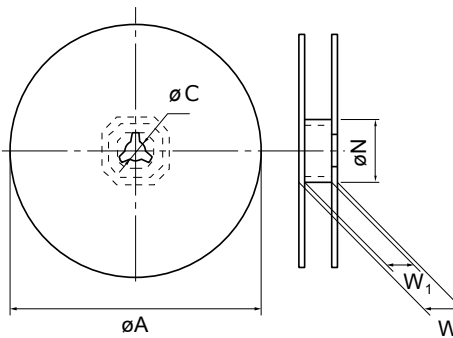

Tape width (W)	Dimensions				
	øA	øN	øC	W <sub>1</sub>	W <sub>2</sub>
4 mm width	180.0±3.0	60.0±1.0/0	13.0±0.2	4.5±0.5	7.0±0.5
8 mm width	180.0 0/-1.5			9.0±1.0/0	11.4±1.0
12 mm width				13.0±1.0/0	15.4±1.0
24 mm width	380.0±2.0	80.0±1.0		25.4±1.0	29.4±1.0

**[Discontinued product]**

**Packaging method**

Surface mount resistors series			Packaging (Standard quantity : pcs/reel)			
Products	Part No.	Size (mm) (inch)	Pressed carrier taping (2 mm pitch)	Punched carrier taping (2 mm pitch)	Punched carrier taping (4 mm pitch)	Embossed carrier taping (4 mm pitch)
Thick film chip resistors/ Low resistance type	ERJL1W	6432 (2512)	—	—	—	3,000
Current sensing resistors, Metal plate type	ERJMP2	3216 (1206)	—	—	—	3,000
	ERJMP3	5025 (2010)	—	—	—	3,000
	ERJMP4	6432 (2512)	—	—	—	2,000
	ERJMS6	6468 (2526)	—	—	—	1,000 (8mm Pitch)
	ERJM1W	6432 (2512)	—	—	—	3,000
Current sensing resistors, Metal foil type	ERJMFBA	1005 (0402)	—	10,000	—	—

**Carrier tape**

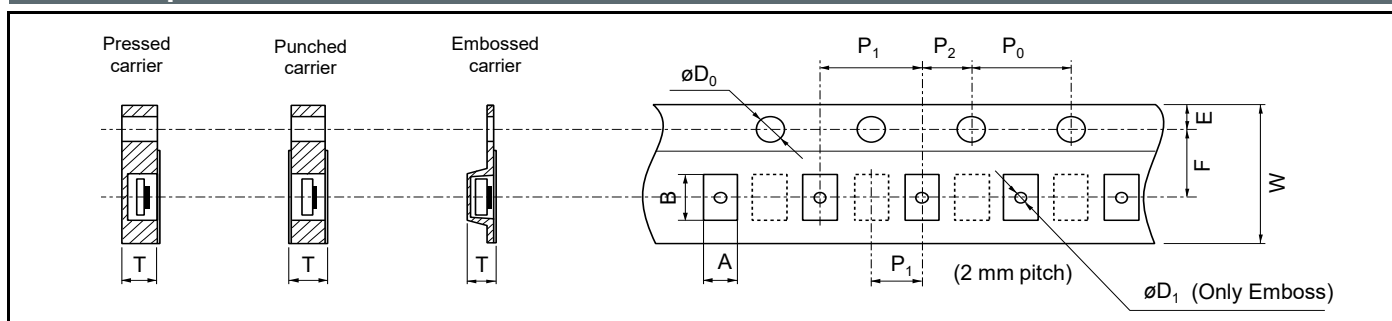

**Punched carrier taping (2 mm Pitch)**

● Chip resistors / Precision chip / Thin film chip / Low resistance / Anti-Surge / Anti-Sulfur / High temperature / Metal foil type Unit : mm

Part No.	Size (inch)	A	B	W	F	E	$P_1$	$P_2$	$P_0$	$\phi D_0$	T
ERJMFBA	1005 (0402)	0.67±0.05	1.17±0.05	8.00±0.20	3.50±0.05	1.75±0.10	2.00±0.10	2.00±0.05	4.00±0.10	1.50 +0.10/0	0.60±0.05

**Embossed carrier taping (4 mm Pitch)**

● Chip resistors / Precision chip / Low resistance / High power / Anti-Surge / Anti-Pulse / Anti-Sulfurated Unit : mm

Part No.	Size (inch)	A	B	W	F	E	$P_1$	$P_2$	$P_0$	$\phi D_0$	T	$\phi D_1$
ERJL1W	6432 (2512)	3.60±0.20	6.90±0.20	12.00 ±0.30	5.50±0.20	1.75 ±0.10	4.00 ±0.10	2.00 ±0.05	4.00 ±0.10	1.50 +0.10/0	1.60±0.10	1.5 min.

● Current sensing resistors, Metal plate type Unit : mm

Part No.	Size (inch)	A	B	W	F	E	$P_1$	$P_2$	$P_0$	$\phi D_0$	T	$\phi D_1$
ERJMP2 (1 mΩ)	3216 (1206)	1.90±0.20	3.50±0.20	8.00±0.30	3.50±0.10	1.75 ±0.10	4.00 ±0.10	2.00 ±0.05	4.00 ±0.10	1.50 +0.10/0	1.55±0.20	—
ERJMP2 (2 mΩ)	3216 (1206)										1.40±0.20	—
ERJMP2 (3~50 mΩ)	3216 (1206)										1.10±0.20	—
ERJMP3 (1~2 mΩ)	5025 (2010)	2.90±0.20	5.40±0.20	12.00 ±0.30	5.50±0.10	1.75 ±0.10	4.00 ±0.10	2.00 ±0.05	4.00 ±0.10	1.50 +0.10/0	1.55±0.20	—
ERJMP3 (3~50 mΩ)	5025 (2010)										1.15±0.20	—
ERJMP4 (1~2 mΩ)	6432 (2512)	3.50±0.20	6.90±0.20	12.00 ±0.30	5.50±0.10	1.75 ±0.10	4.00 ±0.10	2.00 ±0.05	4.00 ±0.10	1.50 +0.10/0	1.60±0.20	1.5 min.
ERJMP4 (3~50 mΩ)	6432 (2512)										1.20±0.20	—
ERJM1W	6432 (2512)										1.80±0.20	1.5 min.

**Embossed carrier taping (8 mm Pitch)**

● Current sensing resistors, Metal plate type Unit : mm

Part No.	Size (inch)	A	B	W	F	E	$P_1$	$P_2$	$P_0$	$\phi D_0$	T	$\phi D_1$
ERJMS6	6468 (2526)	6.90±0.20	7.50±0.20	12.00 ±0.30	5.50±0.05	1.75 ±0.10	8.00 ±0.10	2.00 ±0.05	4.00 ±0.10	1.50 +0.10/0	2.45±0.20	1.5 min.

**Recommended land pattern**

● An example of a land pattern for the rectangular type is shown below.

<Ex.>

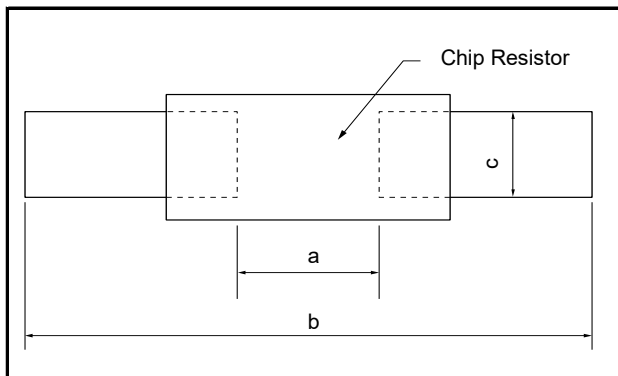

- High temperature type (ERJH)
- High precision type (ERA)
- Current sensing type (ERJ\*L/B/C, ERJ\*R, ERJL)
- Small & high power type (ERJP, ERJT)
- Anti-sulfurated type (ERJS, ERJU)
- General purpose type (ERJ)
- Wide terminal type (ERJA/B/Ds) Unit : mm

Size mm/inch	Dimensions		
	a	b	c
0402/01005	0.15 to 0.20	0.5 to 0.7	0.20 to 0.25
0603/0201	0.3 to 0.4	0.8 to 0.9	0.25 to 0.35
1005/0402	0.5 to 0.6	1.4 to 1.6	0.4 to 0.6
1608/0603	0.7 to 0.9	2.0 to 2.2	0.8 to 1.0
2012/0805	1.0 to 1.4	3.2 to 3.8	0.9 to 1.4
3216/1206	2.0 to 2.4	4.4 to 5.0	1.2 to 1.8
3225/1210	2.0 to 2.4	4.4 to 5.0	1.8 to 2.8
4532/1812	3.3 to 3.7	5.7 to 6.5	2.3 to 3.5
5025/2010	3.6 to 4.0	6.2 to 7.0	1.8 to 2.8
6432/2512	5.0 to 5.4	7.6 to 8.6	2.3 to 3.5
6432/2512*	3.6 to 4.0	7.6 to 8.6	2.3 to 3.5

\* ERJL1W

High power (double-sided resistive elements structure) type

Part No.	Size (inch)	Dimensions		
		a	b	c
ERJ2LW/2BW	1005 (0402)	0.52	1.4 to 1.6	0.4 to 0.6
ERJ3LW/3BW	1608 (0603)	0.5 to 0.8	2.5 to 2.7	0.9 to 1.1
ERJ6LW	2012 (0805)	0.6 to 0.8	3.2 to 3.8	1.1 to 1.4
ERJ6BW		0.9	3.2 to 3.8	1.1 to 1.4
ERJ6CW (10 to 13 mΩ)		0.7 to 0.9	3.2 to 3.8	1.1 to 1.4
ERJ6CW (15 to 30 mΩ)	3216 (1206)	0.9 to 1.1	3.2 to 3.8	1.1 to 1.4
ERJ8BW		1.2	4.4 to 5.0	1.3 to 1.8
ERJ8CW (10 to 16 mΩ)				
ERJ8CW (18 to 50 mΩ)	2.0 to 2.6	4.4 to 5.0	1.2 to 1.8	

Unit : mm

● An example of a land pattern for high power chip resistors / Wide terminal type is shown below.

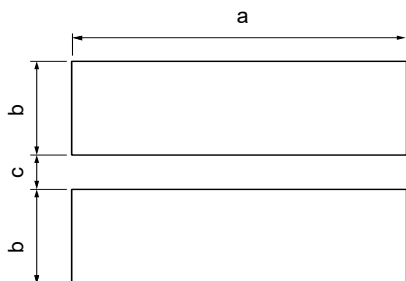

Part No.	Dimensions		
	a	b	c
ERJA1	6.4	1.70	0.60
ERJB1	5.0	1.30	0.75
ERJC1 <sup>*1</sup>			
ERJD1 <sup>*2</sup>	3.2	0.95	0.70
ERJB2			
ERJD2 <sup>*2</sup>			
ERJB3	2.0	0.80	0.60

\*1: Anti-Sulfurated High power chip resistors / Wide terminal type

\*2: Low TCR High power chip resistors / Wide terminal type

**Recommended land pattern**

- An example of a land pattern for Chip Resistor Array, Anti-Sulfurated Chip Resistor Array and Chip Attenuator is shown below.

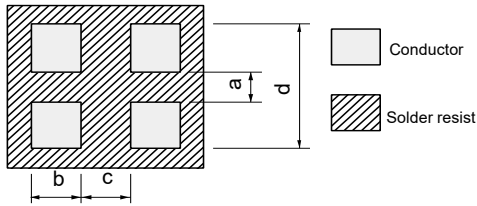

Unit : mm

Part No.	Dimensions			
	a	b	c	d
EXB14V EXB14A	0.30	0.30	0.30	0.80 to 0.90
EXB24V EXBU24 EXB24A	0.5	0.35 to 0.40	0.30	1.4 to 1.5

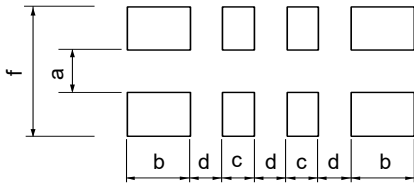

Unit : mm

Part No.	Dimensions				
	a	b	c	d	f
EXB28V EXBU28	0.40	0.525	0.25	0.25	1.40
EXBN8V	0.45 to 0.50	0.35 to 0.38	0.25	0.25	1.40 to 2.00

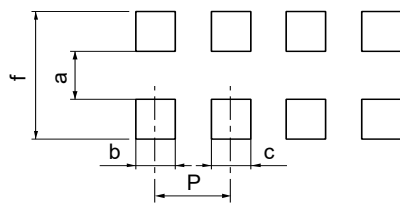

Unit : mm

Part No.	Dimensions				
	a	b	c	f	P
EXB18V	0.20 to 0.30	0.15 to 0.20	0.15 to 0.20	0.80 to 0.90	0.40
EXBV4V EXBV8V	0.7 to 0.9	0.4 to 0.45	0.4 to 0.45	2 to 2.4	0.80
EXB34V EXB38V EXBU34 EXBU38	0.7 to 0.9	0.4 to 0.5	0.4 to 0.5	2.2 to 2.6	0.80
EXBS8V	1 to 1.2	0.5 to 0.75	0.5 to 0.75	3.2 to 3.8	1.27

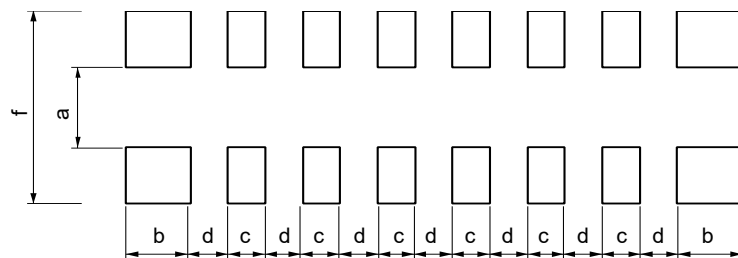

Unit : mm

Part No.	Dimensions				
	a	b	c	d	f
EXB2HV EXBU2H	1.00	0.425	0.25	0.25	2.00

**Recommended land pattern**

● An example of a land pattern for Chip Resistor Networks is shown below.

	EXBA	EXBE
For popular pattern	<p>Pitch 1.27 mm</p>	<p>Pitch 0.8 mm</p>
For high density pattern*	<p>Pitch 0.635 mm Through-hole less</p> <p>EXBA10P EXBA10E</p>	<p>Pitch 0.8 mm Through-hole less</p>
For popular pattern	<p>EXBD</p> <p>Pitch 0.635 mm</p>	<p>EXBQ</p> <p>Pitch 0.5 mm</p>

\* When designing high density land patterns, examine the reliability of isolation among the lines and adopt the chip resistor networks.

**Recommended soldering conditions (Rectangular type)**

Recommendations and precautions are described below.

● **Recommended soldering conditions for reflow**

- Reflow soldering shall be performed a maximum of two times.
- Please contact us for additional information when used in conditions other than those specified.
- Please measure the temperature of the terminals and study every kind of solder and printed circuit board for solderability before actual use.

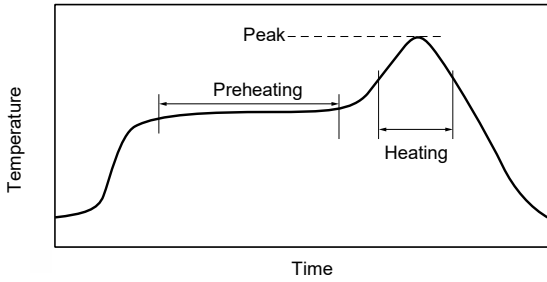

For soldering (Example : Sn/Pb )

	Temperature	Time
Preheating	140 °C to 160 °C	60 s to 120 s
Main heating	Above 200 °C	30 s to 40 s
Peak	235 ± 5 °C	max. 10 s

For lead-free soldering (Example : Sn/Ag/Cu)

	Temperature	Time
Preheating	150 °C to 180 °C	60 s to 120 s
Main heating	Above 230 °C	30 s to 40 s
Peak	max. 260 °C	max. 10 s

● **Recommended soldering conditions for flow**

	For soldering		For lead-free soldering	
	Temperature	Time	Temperature	Time
Preheating	140 °C to 160 °C	60 s to 120 s	150 °C to 180 °C	60 s to 120 s
Soldering	245 ± 5 °C	20 s to 30 s	max. 260 °C	max. 10 s

**Recommended soldering conditions (Chip resistor array / networks and Chip attenuator)**

Recommendations and precautions are described below.

● **Recommended soldering conditions for reflow**

- Reflow soldering shall be performed a maximum of two times.
- Please contact us for additional information when used in conditions other than those specified.
- Please measure the temperature of the terminals and study every kind of solder and printed circuit board for solderability before actual use.

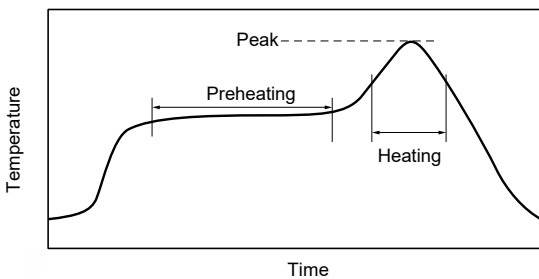

For soldering (Example : Sn/Pb )

	Temperature	Time
Preheating	140 °C to 160 °C	60 s to 120 s
Main heating	Above 200 °C	30 s to 40 s
Peak	235 ± 5 °C	max. 10 s

For lead-free soldering (Example : Sn/Ag/Cu)

	Temperature	Time
Preheating	150 °C to 180 °C	60 s to 120 s
Main heating	Above 230 °C	30 s to 40 s
Peak	max. 260 °C	max. 10 s

● **Flow soldering**

We do not recommend flow soldering, because a solder bridge may form. Please contact us regarding flow soldering of EXBA series.



## Standard for resistance value and resistance tolerance

### Basis standard

IEC Publication 60062 : Marking codes for resistors and capacitors.

IEC Publication 60063 : Preferred number series for resistors and capacitors.

JIS C 5062 : Marking codes for resistors and capacitors.

JIS C 5063 : Preferred number series for resistors and capacitors.

### Resistance values

The resistance values are notched by "Ratio" below in each series.

Series	Resistance tolerance (Standard)	Ratio	Remarks
E6	±20 %	$\sqrt[6]{10}=1.46$	Please refer to standard resistance values shown on this catalog.
E12	±10 %	$\sqrt[12]{10}=1.21$	
E24	± 5 %	$\sqrt[24]{10}=1.10$	
E48	± 2 %	$\sqrt[48]{10}=1.05$	
E96	± 1 %	$\sqrt[96]{10}=1.02$	

### How to express the resistance value with a Panasonic part number

The resistance value expressed in ohms is identified by a three digit number or a four digit number.

The last digit specifies the number of zeroes to follow.

The letter "R" shall be used as the decimal point for less than 10 Ω.

The examples of a three digit number

Resistance code	Value in ohms (Ω)
R56	0.56
5R6	5.6
100	10
271	270
102	1 k
273	27 k
104	100 k
275	2.7 M
106	10 M
107	100 M

The examples of a four digit number

Resistance code	Value in ohms (Ω)
R562	0.562
5R62	5.62
56R2	56.2
1000	100
2711	2.71 k
1002	10 k
2713	271 k
1004	1 M
2751	2.71 M
1006	100 M

### How to express the resistance tolerance with a Panasonic part number

The resistance tolerance is identified by a single letter in accordance with the following table and the code is placed just before the resistance code in the following examples.

Tolerance code	Tolerance (%)	Examples
W	± 0.05	W1001 : 1000 Ω ± 0.05 %
B	± 0.1	B1001 : 1000 Ω ± 0.1 %
C	± 0.25	C1001 : 1000 Ω ± 0.25 %
D	± 0.5	D1001 : 1000 Ω ± 0.5 %
F	± 1	F1001 : 1000 Ω ± 1 %
G	± 2	G1001 : 1000 Ω ± 2 %
J	± 5	J101 : 100 Ω ± 5 %
K	± 10	K101 : 100 Ω ± 10 %
M	± 20	M101 : 100 Ω ± 20 %

**Standard resistance values**

E6	E12	E24	E48	E96	E6	E12	E24	E48	E96	E6	E12	E24	E48	E96										
10	10	10	100	100	22	22	22	215	215	47	47	47	464	464										
				102					475															
			105	105					226					226	487	487								
				107										232		499								
			110	110										24		237	237	51	511	511				
				113													243			523				
		115	115	249				249					249				536			536	536			
			118										255								549			
		12	12						121				121		27						27	56	562	562
													124											576
									127				127			274			274				274	62
			130										280									590		
	133		133	30			287	287				649	649				649							
			137					294	665															
		140	140					316	301						301		68			68	681			
	143		309												698									
	15	15	147											147	33	33		68	715		715			
														150							332	732		
			154				154					348	348	348					75		750	750		
		158					357							768										
		162					162	36	365					365			82			825		825		
			165				374							806										
	169		169				39							383	383	82		866				866		
		174	392												887									
18	18	178	178	39	39	82				825	825													
			182								392	845												
		187	187						43	402	402	91	909		909									
	191		412								866													
	196		196				442				422			422	91	953	953							
		200	432											931										
20	205	205	442	442	91	953								953										
		210		453										976										

## Safety Precautions

When using our products, no matter what sort of equipment they might be used for, be sure to confirm the applications and environmental conditions with our specifications in advance.

**Panasonic**  
INDUSTRY

Panasonic Industry Co., Ltd.  
Device Solutions Business Division

1006 Kadoma, Kadoma City, Osaka  
571-8506 Japan