

Bidirectional, Wide Positive and Negative Sensing Range, Current-Sense Amplifier with Fast PWM Rejection

MAX49925

General Description

The MAX49925 is a bidirectional current-sense amplifier (CSA) with an input common-mode range that extends from -40V to +76V, making it suitable for 48V HEV applications where there are large automotive transients.

This CSA has an extended input protection range of -42V to +80V against reverse-battery and high-voltage spikes. The wider input protection range also helps relax TVS requirements, leading to lower BOM cost and reduced component size.

The MAX49925 is well-suited for phase-current monitoring of inductive loads, such as motors and solenoids, where pulse-width modulation (PWM) is used to control the drive voltage and current.

The MAX49925 uses an improved technique to help reject common-mode input PWM edges with slew rates up to and beyond 500V/ μ s.

The MAX49925 operates over the full -40°C to +125°C temperature range and runs from a supply voltage of +2.7V to +5.5V. It is available in a 3mm x 3mm, 10-pin TDFN package with side-wettable flanks.

Applications

- PWM H-Bridge Motor In-Line/In-Phase/Winding Current Sensing
- Solenoid Current Sensing
- Current Monitoring of Inductive Loads
- Battery Stack Monitors
- High-Power DC Motors
- Automotive
- 48V Hybrid and Electric Vehicles (HEV)

Benefits and Features

- Fast, 500ns PWM Edge Recovery from >500V/ μ s PWM Edges
- 140dB DC CMRR Rejection
- -40V to +76V Input Voltage Range
- -42V to +80V Protective Immunity
- 300kHz, -3dB Bandwidth
- On-the-fly Programmable Gain with two input pins: 10V/V, 20V/V, 50V/V, 100V/V
- 5 μ V (typ) Input Offset Voltage
- \pm 0.3% (max) Gain Error
- Rail-to-Rail Output
- 3mm x 3mm, 10-Pin TDFN with Side-Wettable Flanks
- -40°C to +125°C Temperature Range, Automotive Grade 2
- AEC-Q100 Qualified

[Ordering Information](#) appears at end of data sheet.

Simplified Block Diagram

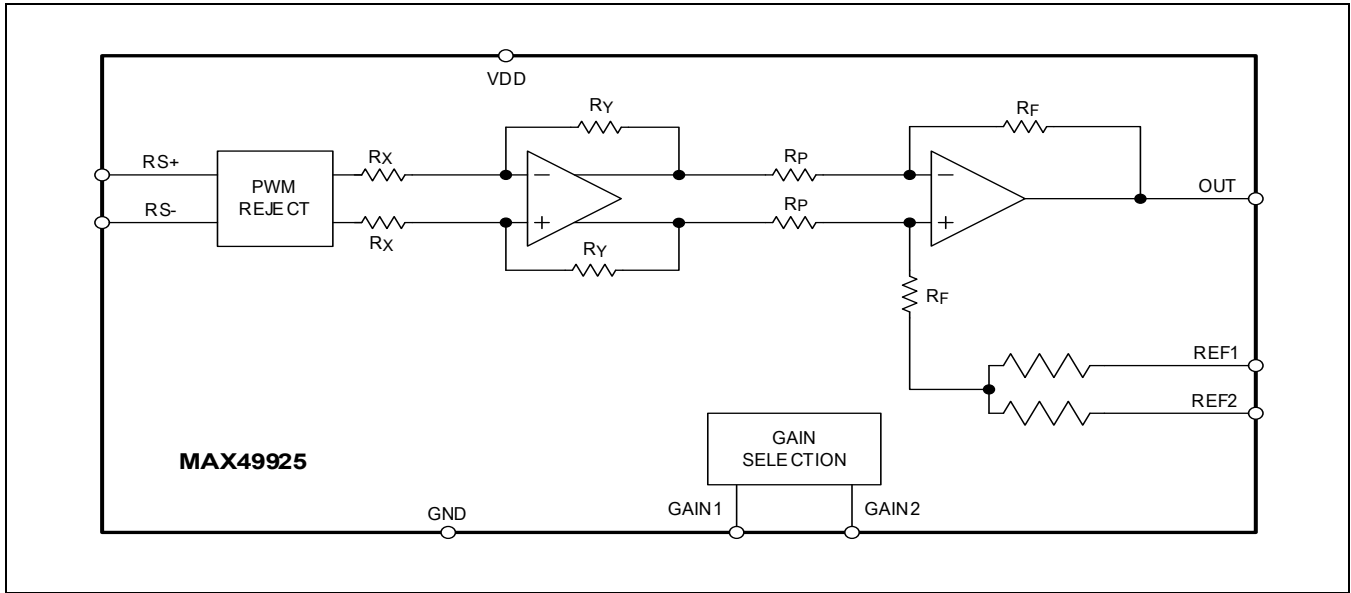

Absolute Maximum Ratings

RS+ and RS- to GND -42V to +80V
 RS+ to RS- ±2V
 VDD to GND -0.3V to +6V
 REF1, REF2, GAIN1, GAIN2, OUT to GND-0.3V to VDD + 0.3V
 Continuous Current in REF1, REF2, GAIN1, GAIN2 10mA

Continuous Current in OUT 10mA
 Continuous Current in RS+ and RS- 10mA
 Continuous Power Dissipation (Multilayer Board) (TA = +70°C, derate 24.4mW/°C above +70°C) 1951.20mW
 Operating Temperature Range -40°C to +125°C
 Storage Temperature Range -65°C to +150°C

Stresses beyond those listed under "Absolute Maximum Ratings" may cause permanent damage to the device. These are stress ratings only, and functional operation of the device at these or any other conditions beyond those indicated in the operational sections of the specifications is not implied. Exposure to absolute maximum rating conditions for extended periods may affect device reliability.

Package Information

10 TDFN

Package Code	T1033Y+1C	T1033+1C
Outline Number	21-100346	21-0137
Land Pattern Number	90-0003	
Thermal Resistance, Four-Layer Board:		
Junction to Ambient (θJA)	41°C/W	
Junction to Case (θJC)	9°C/W	

For the latest package outline information and land patterns (footprints), go to www.maximintegrated.com/packages. Note that a "+", "#", or "-" in the package code indicates RoHS status only. Package drawings may show a different suffix character, but the drawing pertains to the package regardless of RoHS status.

Electrical Characteristics

($V_{DD} = 3.3V$, $V_{CM} = 48V$, $V_{SENSE} = 800mV/gain$, $V_{REF1} = V_{DD}/2$, $V_{REF2} = V_{DD}/2$, OUT Loading = 10k Ω and 20pF to GND, $T_{MIN} = -40^{\circ}C$, $T_{MAX} = +125^{\circ}C$)

PARAMETER	SYMBOL	CONDITIONS	MIN	TYP	MAX	UNITS
POWER SUPPLY CHARACTERISTICS						
Supply Voltage	V_{DD}	Guaranteed by PSRR	2.7		5.5	V
Supply Current	I_{DD}			5	7	mA
Power-Up Time	t_{PWR_UP}	Out settle within 1%		200		μs
CURRENT-SENSE AMPLIFIER—DC CHARACTERISTICS						
Input-Protected Common-Mode Range	V_{CM_P}		-42		+80	V
Input Common-Mode Range	V_{CM}	$-40^{\circ}C \leq T_A \leq +125^{\circ}C$	-40		+76	V
Input Bias Current	I_{RS+}, I_{RS-}	$V_{SENSE} = 0V$ (Note 1)		3	300	nA
		$V_{SENSE} = 20mV$		3.5	6	μA
Input Leakage Current	I_{LKG}	$V_{DD} = 0V, 0V \leq V_{RS\pm} \leq 65V$ (Note 1)		3	400	nA
Input Offset Voltage	V_{OS}	$T_A = +25^{\circ}C$		5	20	μV
		$-40^{\circ}C \leq T_A \leq +125^{\circ}C$			200	
Input Offset Drift	TCV_{OS}			0.05		$\mu V/^{\circ}C$
Power Supply Rejection Ratio	PSRR	$2.7V \leq V_{DD} \leq 5.5V$	90	110		dB
Common-Mode Rejection Ratio	CMRR	$-40V \leq V_{CM} \leq +76V; -40^{\circ}C \leq T_A \leq +125^{\circ}C$	120	140		dB
Input Capacitance	C_{IN}	RS+ and RS- input		3		pF
Nominal Gain	G	GAIN1 = GND, GAIN2 = GND		10		V/V
		GAIN1 = V_{DD} , GAIN2 = GND		20		
		GAIN1 = GND, GAIN2 = V_{DD}		50		
		GAIN1 = V_{DD} , GAIN2 = V_{DD}		100		
Gain Error	GE	$-40^{\circ}C \leq T_A \leq +125^{\circ}C, -800mV/gain \leq V_{SENSE} \leq 800mV/gain$		0.05	0.3	%
Output Voltage Swing High	V_{OH}	Sourcing 5mA; $V_{OH} = V_{DD} - V_{OUT}$		45	100	mV
Output Voltage Swing Low	V_{OL}	Sinking 5mA; $V_{OL} = V_{OUT} - GND$		35	70	mV
Output Short-Circuit Current	I_{SC}	Shorted to either V_{DD} or GND		20		mA
Reference Voltage Rejection Ratio	RRRR			2		$\mu V/V$
CURRENT SENSE AMPLIFIER—AC CHARACTERISTICS						
Signal Bandwidth	BW_{-3dB}			300		kHz
Output Slew Rate	SR	2V _{P-P} output square wave, centered at 1.65V		1.5		V/ μs
Amplifier Small-Signal Settling Time (1%)	t_s	$\pm 200mV$ output step		2.5		μs
PWM Edge Recovery Settling Time	t_{s_PWM}	0 to 50V edges: 500V/ μs rise/fall times, $V_{SENSE} = 0mV$ ($V_{RS+} = V_{RS-}$)		500		ns
AC Common-Mode Rejection Ratio	AC CMRR	100mV _{AC} sine, f = 100kHz		60		dB

($V_{DD} = 3.3V$, $V_{CM} = 48V$, $V_{SENSE} = 800mV/gain$, $V_{REF1} = V_{DD}/2$, $V_{REF2} = V_{DD}/2$, OUT Loading = $10k\Omega$ and $20pF$ to GND, $T_{MIN} = -40^{\circ}C$, $T_{MAX} = +125^{\circ}C$)

PARAMETER	SYMBOL	CONDITIONS	MIN	TYP	MAX	UNITS
AC Power Supply Rejection Ratio	AC PSRR	100mV _{AC} sine, f = 100kHz		60		dB
Voltage Noise Density	e _n	At 10kHz		150		nV/ \sqrt{Hz}
CURRENT SENSE AMPLIFIER—LOGIC INPUT DC CHARACTERISTICS						
Input Low Level	V _{IL}				0.55	V
Input High Level	V _{IH}		1.3			V
Input Leakage Current	I _L			3	30	nA

Note 1: Limits are 100% tested at $T_A = +25^{\circ}C$. Limits over the operating temperature range and relevant supply voltage range are guaranteed by design and characterization.

Typical Operating Characteristics

($V_{DD} = 3.3V$, $V_{SENSE} = 800mV/gain$, $V_{CM} = 48V$, OUT load = $10k\Omega$ and $20pF$ to GND, $T_A = +25^{\circ}C$, unless otherwise noted.)

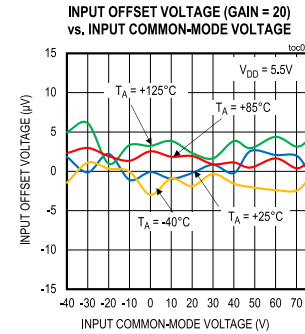
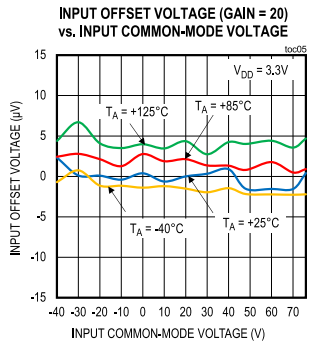
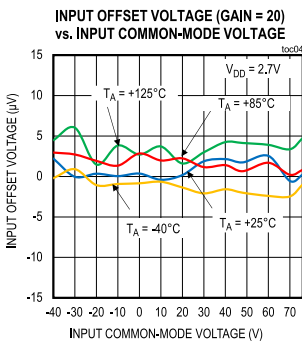
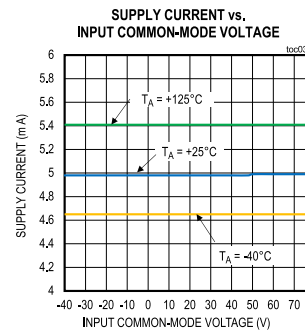
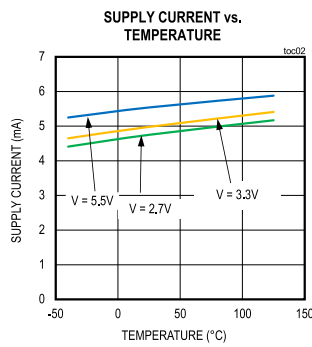
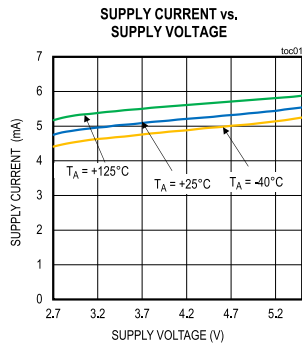

Bidirectional, Wide Positive and Negative Sensing Range, Current-Sense Amplifier with Fast PWM Rejection

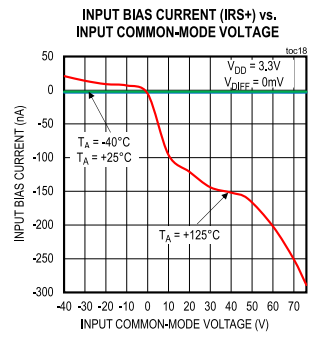
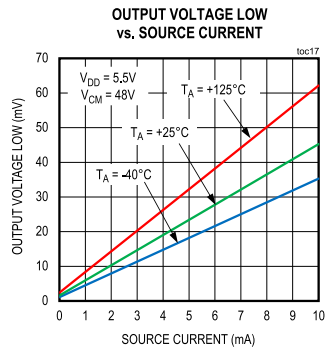
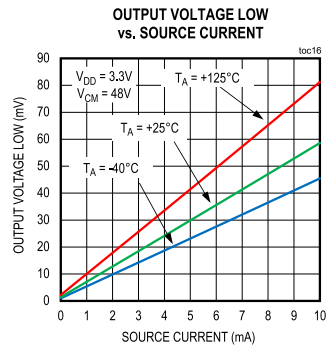
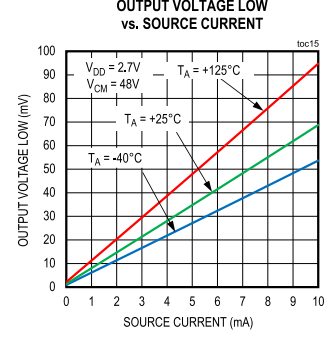
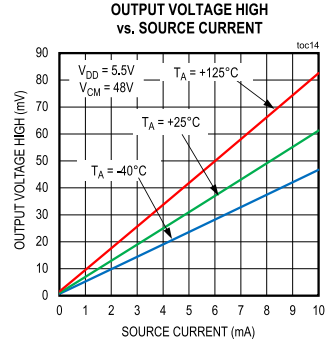
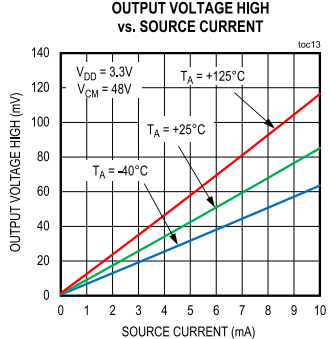
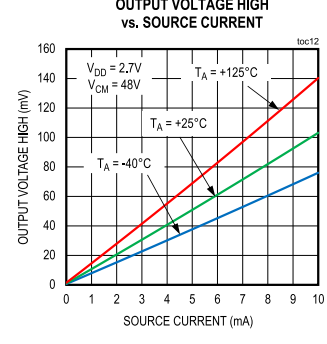
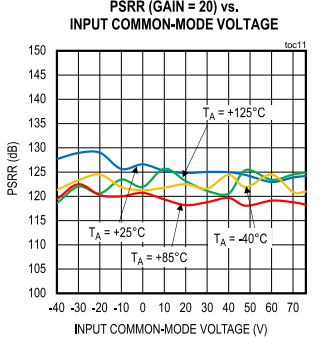
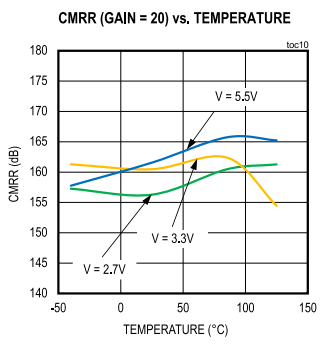
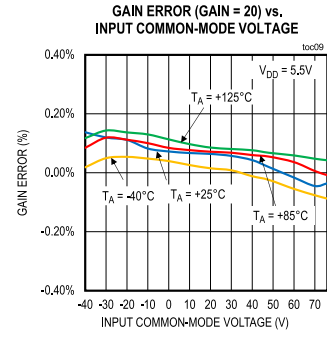
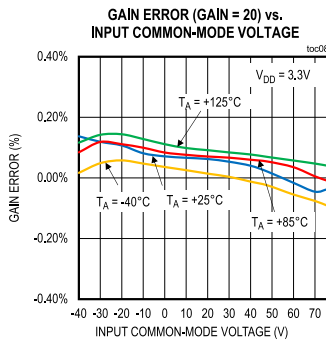
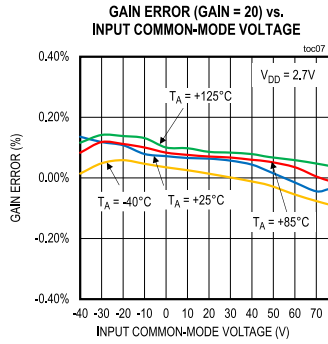

Bidirectional, Wide Positive and Negative Sensing Range, Current-Sense Amplifier with Fast PWM Rejection

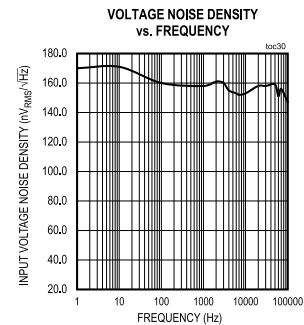
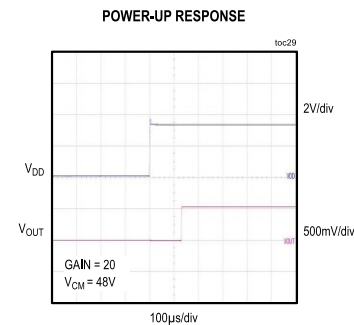
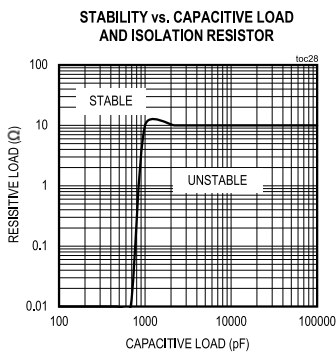
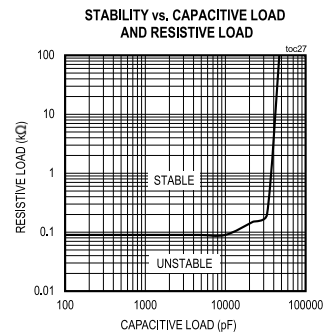
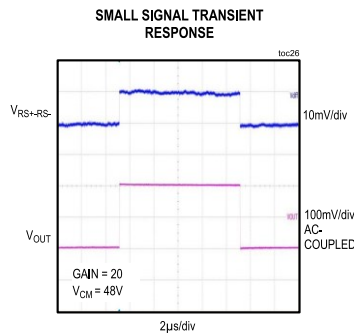
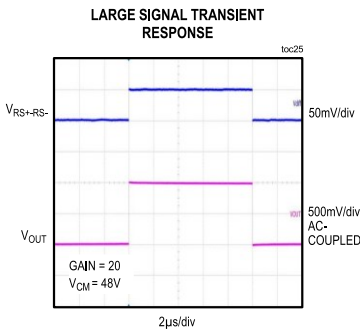
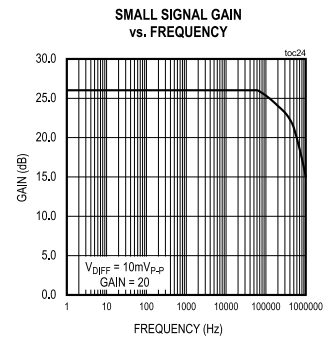
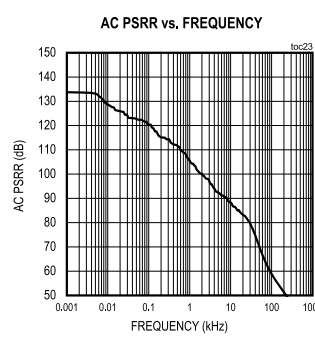
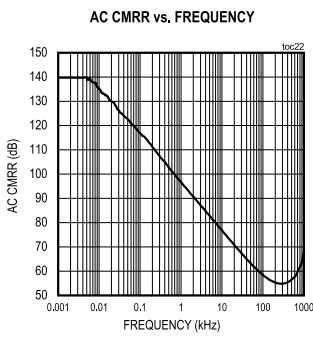
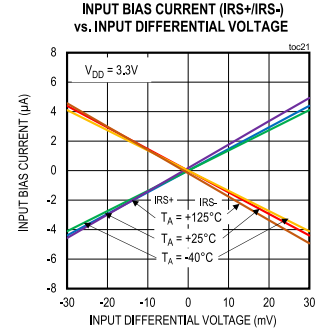
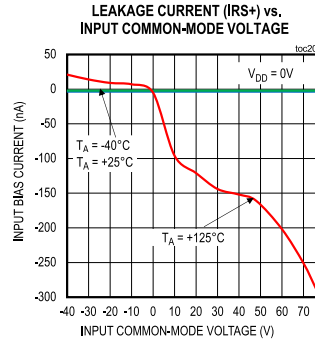
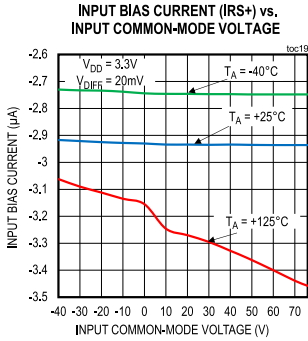

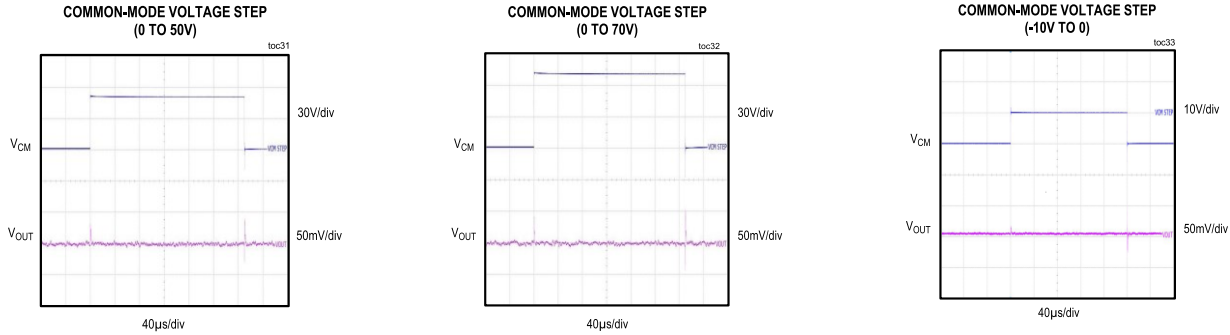

Pin Configurations

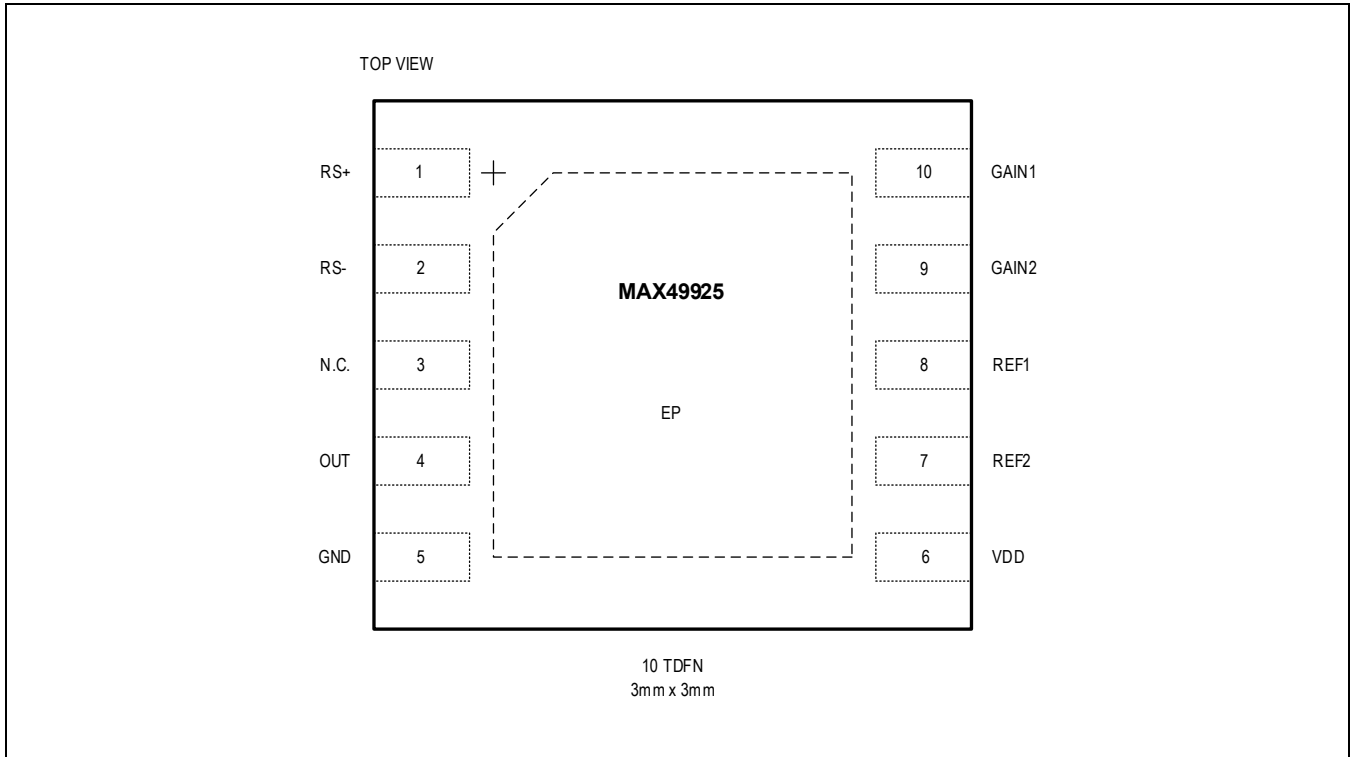

Pin Descriptions

PIN	NAME	FUNCTION
1	RS+	External Resistor Power-Side Connection Input
2	RS-	External Resistor Load-Side Connection Input
3	N.C.	Not Connected
4	OUT	Current-Sense Output. Output has its common-mode point at V_{REF} .
5	GND	Ground. Signal and power return.
6	VDD	Supply Voltage Input. Bypass to ground with a 10nF COG\NPO and 1µF X5R.

7	REF2	Reference Input 2
8	REF1	Reference Input 1
9	GAIN2	Gain Selection Input 2
10	GAIN1	Gain Selection Input 1

Detailed Description

Overview

The MAX49925 is a single-supply, high-accuracy, bidirectional current-sense amplifier with a high common-mode input range extending from -40V to +76V. The input stage provides protection against voltage spikes and inductive kickbacks from -42V up to +80V. The $\pm 5\mu\text{V}$ (typ) input offset voltage and 0.3% (max) gain error help to ensure low system errors.

The input stage is specifically designed to suppress the disturbance of fast-PWM signals, which are common in motor control applications. The MAX49925 is well-suited for in-phase current monitoring of inductive loads, such as motor windings and solenoids that are driven by PWM signals. The MAX49925 is specified over the temperature range of -40°C to +125°C and operates over the supply range of +2.7V and +5.5V.

The MAX49925 offers four gain options using GAIN1 and GAIN2.

PWM Rejection Input Stage

The proprietary input architecture is immune to the large PWM disturbances present in typical motor control applications. The input stage is designed to withstand -40V to +76V common-mode input voltage without damage. The MAX49925's output recovers within 500ns from PWM edges with slew rates up to and beyond $\pm 500\text{V}/\mu\text{s}$.

Low Input Offset Voltage and Low Gain Error

The low input offset voltage of the MAX49925 allows accurate current measurement with low current-sense resistor values. In addition, low current-sense resistors help minimize power dissipation and increase system efficiency. This technique also enables extremely low input offset voltage drift over time and temperature to $50\text{nV}/^\circ\text{C}$. The optimized gain architecture achieves a gain error of less than 0.3% over the entire temperature range of -40°C to +125°C.

Output Stage

Use the following equation to set the gain:

$$V_{\text{OUT}} = \{I_{\text{SENSE}} \times R_{\text{SENSE}}\} \times \text{GAIN} + V_{\text{REF}} \dots (1)$$

Where I_{SENSE} is the current through the sense resistor, R_{SENSE} is the sense resistor value, and GAIN is the voltage gain of the MAX49925. The output stage is needed to generate suitable output voltage levels and set the different gain by external gain setting pins. This is an external voltage reference connected to REF1 and REF2 input. When the sense current is positive (the current flows from the RS+ input to the RS- input through the sense resistor), the output voltage is greater than $V_{\text{REF}} = (V_{\text{REF1}} + V_{\text{REF2}})/2$ (V), when the sense current is negative, the output voltage is less than $V_{\text{REF}} = (V_{\text{REF1}} + V_{\text{REF2}})/2$ (V) indicating negative currents flowing with respect to RS+ and RS- inputs.

Applications Information

Important Considerations

Stray Inductance

The stray inductance due to package parasitics in the current-sense resistor must be kept to a minimum. The unwanted voltage error produced by the stray inductance is proportional to the magnitude of the load current. Wire-wound resistors have the highest inductance, while metal film is comparably better. Low-inductance, metal-film resistors are also available. Instead of being spiral wrapped around a core, as in metal-film or wire-wound resistors, they are straight bands of metal and are available in values under 100mΩ.

Kelvin Connections

Due to the high currents that may flow through R_{SENSE} , take care to eliminate solder and parasitic trace resistance from causing errors in the sense voltage. Either use a four-terminal current sense resistor or use Kelvin (force and sense) PCB layout techniques. [Figure 1](#) shows a typical routing of Kelvin-sensed traces to the inputs of the MAX49925. The Kelvin-sense traces should be as close as possible to the current-sense resistor's solder contact pads. If the Kelvin-sensing contact pads are spaced wider relative to the sense resistor, error is introduced from the additional trace resistance.

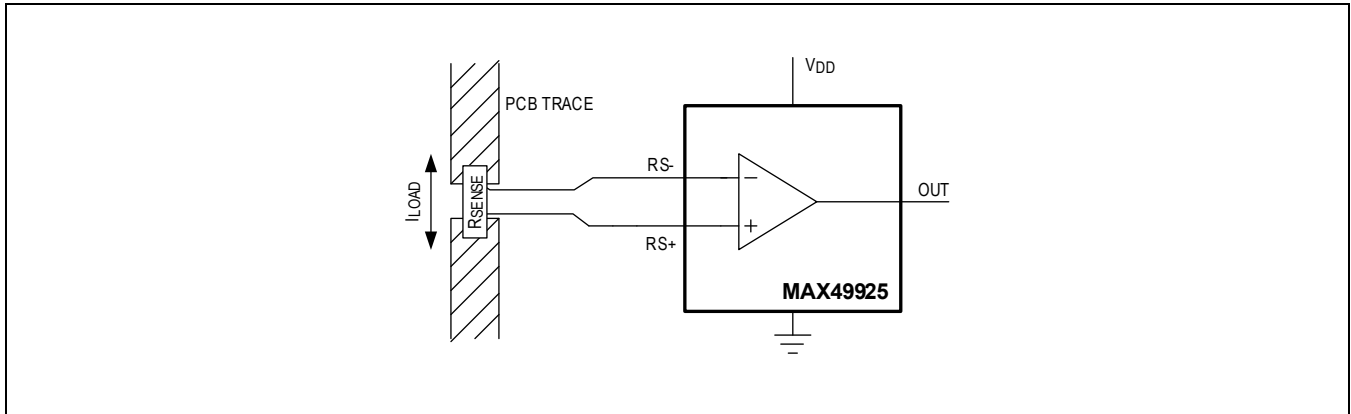
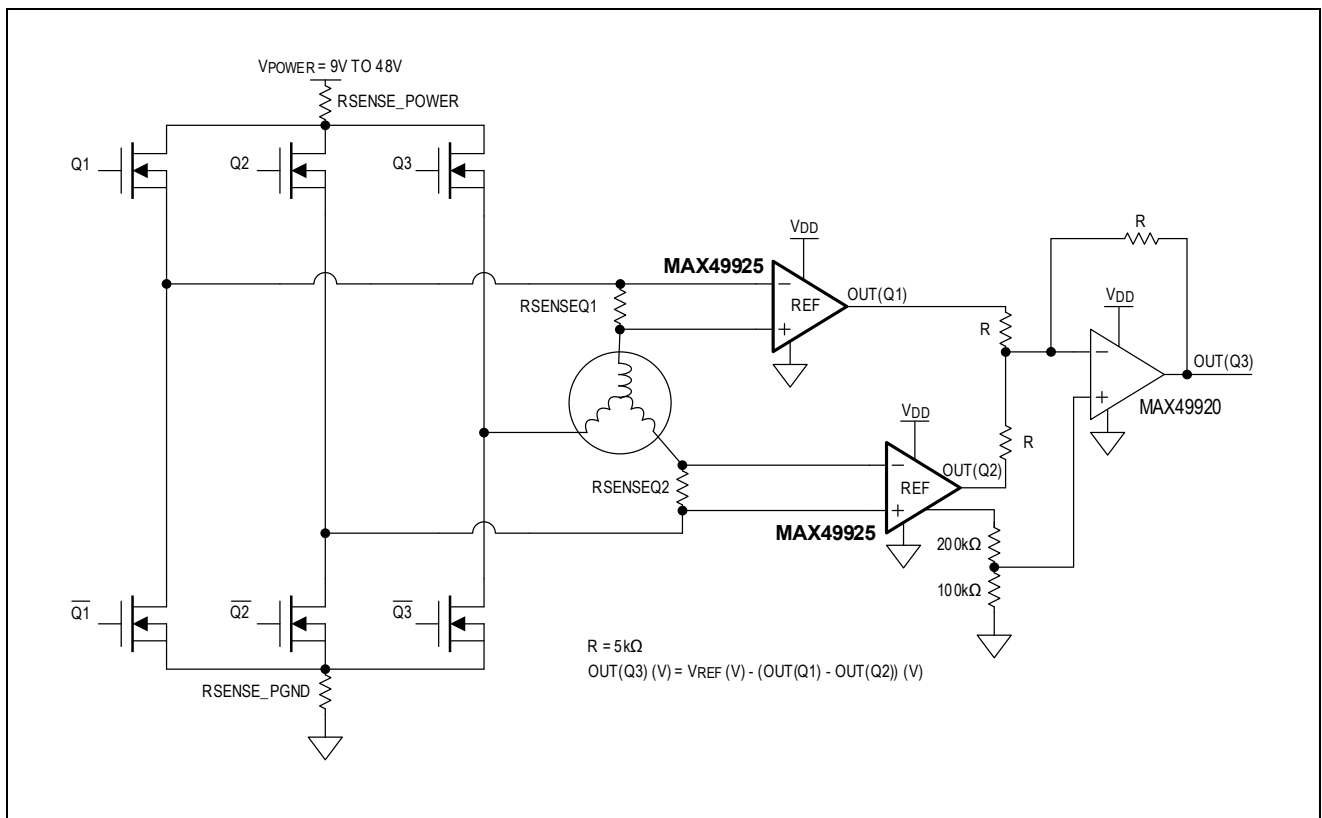

Figure 1. Kelvin Sensing

Typical Application Circuits

Current Sensing in a 3-Phase Servo Motor



Ordering Information

PART NUMBER	TEMP RANGE	PIN-PACKAGE	TOP MARK	PACKAGE CODE
MAX49925ATB/VY+	-40°C to +125°C	10 TDFN	BEI	T1033Y+1C
MAX49925ATB/VY+T	-40°C to +125°C	10 TDFN	BEI	T1033Y+1C
MAX49925XATB+	-40°C to +125°C	10 TDFN	BER	T1033+1C
MAX49925XATB+T	-40°C to +125°C	10 TDFN	BER	T1033+1C

+Denotes a lead (Pb)-free/RoHS-compliant package.

T = Tape and reel.

X denotes an industrial qualified part.

/V denotes an automotive qualified part.

Y = Side-wettable package.

Revision History

REVISION NUMBER	REVISION DATE	DESCRIPTION	PAGES CHANGED
0	1/23	Initial release	—
1	4/23	Updated Benefits and Features, Electrical Characteristics table, and Ordering Information table	1, 3, 4, 11
2	7/23	Updated Title and <i>Benefits and Features</i> section	1-12

