

22 W auxiliary power supply for indoor air conditioner using CoolSET™ ICE5BR2280BZ-1

REF_5BR2280BZ-1_22W1

About this document

Scope and purpose

This document is a reference design for a 22 W auxiliary power supply for a residential air conditioner unit with the latest CoolSET™ 5th Generation Fixed Frequency Plus ICE5BR2280BZ-1 switching controller from Infineon. The power supply is designed with a universal input compatible with most geographic regions and three outputs (+12 V/1.4 A isolated, +5 V/0.3 A isolated, and +15 V/150 mA non-isolated).

Highlights of the auxiliary power supply for an indoor air conditioner unit are:

- Tightly regulated output voltages, high efficiency under light load, and low standby power
- Comprehensive protection for a robust system
- Auto-restart protection scheme to minimize interruption and enhance user-friendly experience

Intended audience

This document is intended for power supply design engineers who are designing auxiliary power supplies for residential air conditioner units that are efficient, reliable, and easy to design.

CoolSET™

Infineon's CoolSET™ AC-DC integrated power stages in fixed-frequency switching scheme offers increased robustness and outstanding performance. This family offers superior energy efficiency, comprehensive protective features, and reduced system costs and is ideally suited for auxiliary power supply applications in a wide variety of potential applications such as:

- [SMPS](#)
- [Home appliances](#)
- [Server](#)
- [Telecom](#)

22 W auxiliary power supply for indoor air conditioner using CoolSET™ ICE5BR2280BZ-1

REF_5BR2280BZ-1_22W1

Table of contents

Table of contents

About this document	1
Table of contents	2
1 Introduction	4
1.1 High efficiency under light load and low standby power	5
1.2 Simplified circuitry with good integration of power and protection features.....	5
1.3 Auto-restart protection scheme to minimize interruption to enhance end-user experience.....	5
2 Reference board design	6
3 Power supply specifications	7
4 Schematic	8
5 Circuit description	9
5.1 EMI filtering and line rectification.....	9
5.2 Flyback converter power stage.....	9
5.3 Control of flyback converter through CoolSET™ 5 th Generation Fixed Frequency Plus ICE5BR2280BZ-1 switching controller	9
5.3.1 Current sensing	9
5.3.2 Feedback and compensation network.....	9
5.4 Unique features	10
5.4.1 Fast self-start-up and sustaining of V_{CC}	10
5.4.2 CCM, DCM operation with frequency reduction.....	10
5.4.3 Frequency jittering with modulated gate drive	11
5.4.4 System robustness and reliability through protection features	11
5.5 Clamper circuit	11
5.6 PCB design recommendations	11
6 PCB layout	13
6.1 Top side	13
6.2 Bottom side	13
7 Bill of materials	14
8 Transformer specification	16
9 Measurement data and graphs	17
9.1 Efficiency curve.....	19
9.2 Standby power	20
9.3 Line and load regulation	20
9.4 Maximum input power	21
9.5 ESD immunity (EN 61000-4-2)	21
9.6 Surge immunity (EN 61000-4-5)	22
9.7 Conducted emissions (EN 55022 Class-B)	22
9.8 Thermal measurement	23
9.9 +18 V rail regulation (LDO input).....	24
10 Waveforms and oscilloscope plots	26
10.1 Start-up at full load	26
10.2 Soft-start at full load	26
10.3 Drain and CS voltage at full load	27
10.4 Frequency jittering.....	27
10.5 Load-transient response	28

22 W auxiliary power supply for indoor air conditioner using CoolSET™ ICE5BR2280BZ-1

REF_5BR2280BZ-1_22W1

Table of contents

10.6	Output ripple voltage at full load	28
10.7	Output ripple voltage at ABM.....	29
10.8	Entering ABM	29
10.9	During ABM	30
10.10	Leaving ABM	30
10.11	V _{CC} OV/UV protection	31
10.12	Overload protection	31
References.....		32
Design support		33
Revision history.....		34
Disclaimer.....		35

22 W auxiliary power supply for indoor air conditioner using CoolSET™ ICE5BR2280BZ-1

REF_5BR2280BZ-1_22W1

Introduction

1 Introduction

With the growing household trend for internet-connected devices, the new generation of home appliances such as air conditioners are equipped with advanced features such as wireless control and monitoring capability, smart sensors, and touch screen display. These can transform a static product into an interactive and intelligent home appliance, capable of adapting to the smart-home theme. Infineon has introduced the latest CoolSET™ 5th Generation Fixed Frequency Plus ICE5BR2280BZ-1 switching controller to address this need in an efficient and cost-effective manner.

An auxiliary SMPS is needed to power the various modules and sensors, which typically operate from a stable DC voltage source. The CoolSET™ switching controller (as shown in Figure 1) forms the heart of the system, providing the necessary protection and AC-DC conversion from the mains to multiple regulated DC voltages to power the various blocks.

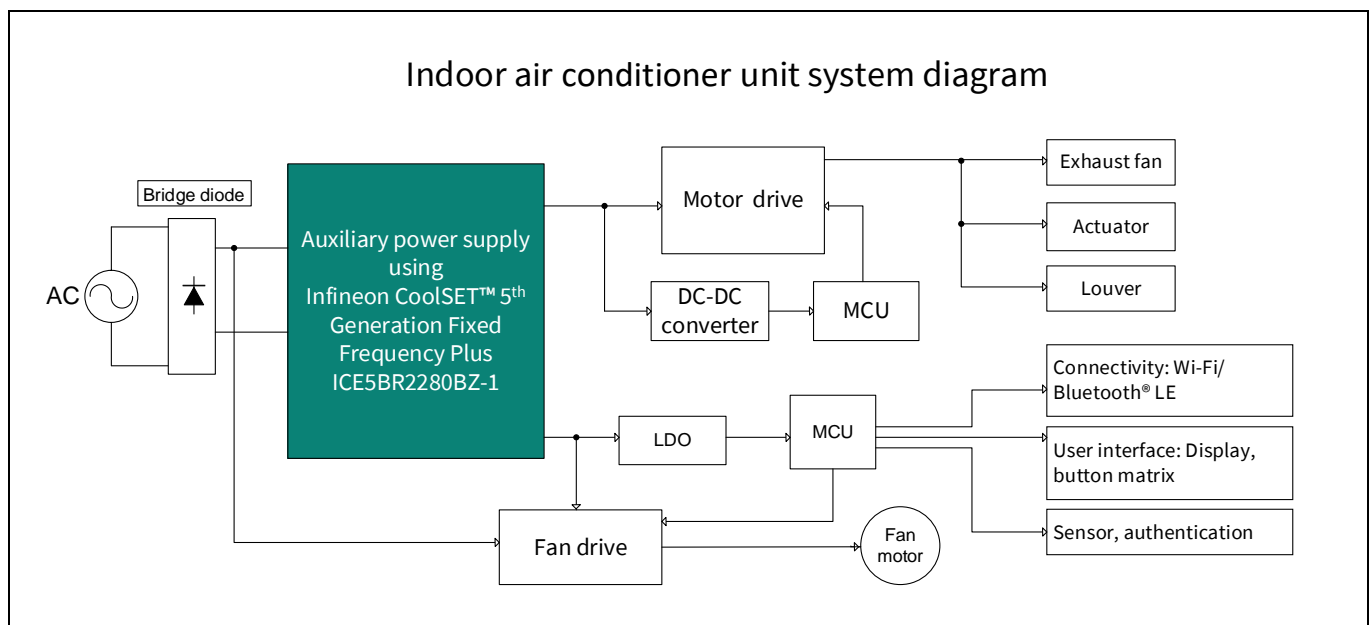

Figure 1 Simplified indoor air conditioner system diagram

Table 1 lists the system requirements for an auxiliary power supply for an indoor air conditioner unit and the corresponding Infineon solution is shown in the right column.

Table 1 System requirements and Infineon solutions

	System requirement for indoor air conditioner unit power supply	Infineon solution – ICE5BR2280BZ-1
1	High efficiency under light load and low standby power	Digital frequency reduction and active burst mode (ABM)
2	Robust system and protection features	Comprehensive protection feature CoolSET™ switching controller in DIP-7 package
3	Auto-restart protection scheme to minimize interruption to enhance end-user experience	All protections are in auto restart

22 W auxiliary power supply for indoor air conditioner using CoolSET™ ICE5BR2280BZ-1

REF_5BR2280BZ-1_22W1

Introduction

1.1 High efficiency under light load and low standby power

During indoor air conditioner operation, the power requirement fluctuates according to various use cases. However, in most cases where room temperature is already stabilized, the indoor and outdoor air conditioner units will reside in an idle state, in which the loading toward the auxiliary power supply is low. It is crucial that the auxiliary power supply operates as efficiently as possible, because it will be in this particular state for most of the period. Under light-load conditions, losses incurred with the power switch are usually dominated by the switching operation. The choice of switching scheme and frequency play a crucial role in ensuring high conversion efficiency.

In this reference design, ICE5BR2280BZ-1 is primarily chosen because of its frequency reduction switching scheme. Compared with a traditional Fixed Frequency flyback, the CoolSET™ switching controller reduces its switching frequency from medium to light load, minimizing the switching losses. Therefore, an efficiency of more than 80 percent is achievable under 25 percent load conditions and nominal input voltages.

1.2 Simplified circuitry with good integration of power and protection features

To relieve the designer of the complexity of PCB layout and circuit design, the CoolSET™ switching controller is a highly integrated device with both a controller and a HV MOSFET integrated into a single, space-saving DIP-7 package. These certainly help the designer to reduce component count as well as simplifying the layout into a simple PCB design for ease of manufacturing, using the traditional cost-effective wave-soldering process.

1.3 Auto-restart protection scheme to minimize interruption to enhance end-user experience

For a residential air conditioner unit, it would be discomfoting to both the end user and the manufacturer if the system were to halt and latch after protection. Accessibility of the input AC plug may also be difficult; therefore, to minimize interruption, the CoolSET™ switching controller implements an auto-restart mode for all abnormal protections.

22 W auxiliary power supply for indoor air conditioner using CoolSET™ ICE5BR2280BZ-1

REF_5BR2280BZ-1_22W1

Reference board design

2 Reference board design

This document provides complete design details including specifications, schematics, bill of materials (BOM), PCB layout, and transformer design. This information also includes performance results pertaining to line/load regulation, efficiency, transient load, thermal conditions, conducted EMI scans, etc.

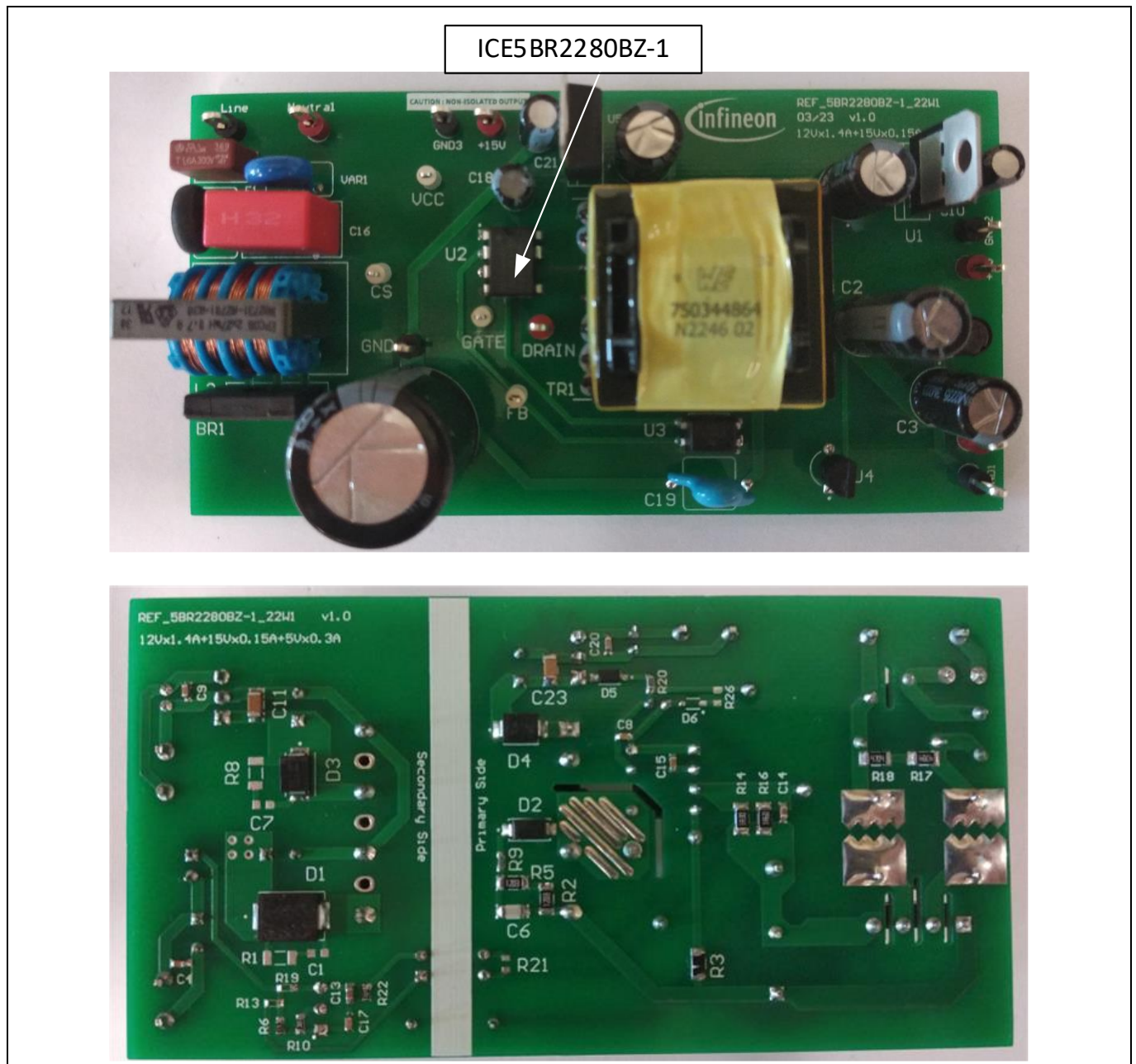

Figure 2 REF_5BR2280BZ-1_22W1

22 W auxiliary power supply for indoor air conditioner using CoolSET™ ICE5BR2280BZ-1



REF_5BR2280BZ-1_22W1

Power supply specifications

3 Power supply specifications

Table 2 shows the minimum acceptable performance of the design at 25°C ambient temperature. Actual performance is listed in the measurements section.

Table 2 Specifications of REF_5BR2280BZ-1_22W1

Description	Symbol	Min.	Typ.	Max.	Unit	Comments
Input						
Voltage	V_{IN}	85	–	264	V AC	2 wires (no P.E.)
Frequency	f_{LINE}	47	50/60	64	Hz	
No-load input power	P_{stby_NL}	–	–	120	mW	
Output						
Output voltage 1	V_{O1}	–	12	–	V	± 1 percent
Output current 1	I_{O1}	–	–	1.4	A	
Output voltage ripple 1	$V_{RIPPLE1}$	–	–	120	mV	
Output voltage 2	V_{O2}	–	5	–	V	± 1 percent
Output current 2	I_{O2}	5	–	300	mA	
Output voltage ripple 2	$V_{RIPPLE2}$	–	–	75	mV	
Output voltage 3	V_{O3}	–	15	–	V	± 1 percent
Output current 3	I_{O3}	5	–	150	mA	
Output voltage ripple 3	$V_{RIPPLE3}$	–	–	100	mV	
Output power	P_{OUT_Nom}	–	19.75	–	W	–
Overcurrent protection (+12 V)	I_{OCP}	–	1.5	–	A	0.15 A load on 15 V and 0.5 A load on 5 V load
Start-up time	t_{start_up}	–	–	250	ms	–
Efficiency						
Maximum load	η	75	–	–	%	115 V AC/230 V AC
Average efficiency	η_{avg}	75	–	–	%	
Maximum load (single output)	η_s	83	–	–	%	
Average efficiency (single output)	η_{avg_s}	83	–	–	%	
Environmental						
Conducted EMI	–	6	–	–	dB	Margin, CISPR 22 Class-B
ESD	–	±6	–	–	kV	EN 61000-4-2
Surge immunity						
Differential Mode (DM)	–	±2	–	–	kV	EN 61000-4-5
Common Mode (CM)	–	±4	–	–	kV	
PCB dimension						
PCB	–	110 × 57 × 23			mm	L × W × H

22 W auxiliary power supply for indoor air conditioner using CoolSET™ ICE5BR2280BZ-1

REF_5BR2280BZ-1_22W1

Schematic

4 Schematic

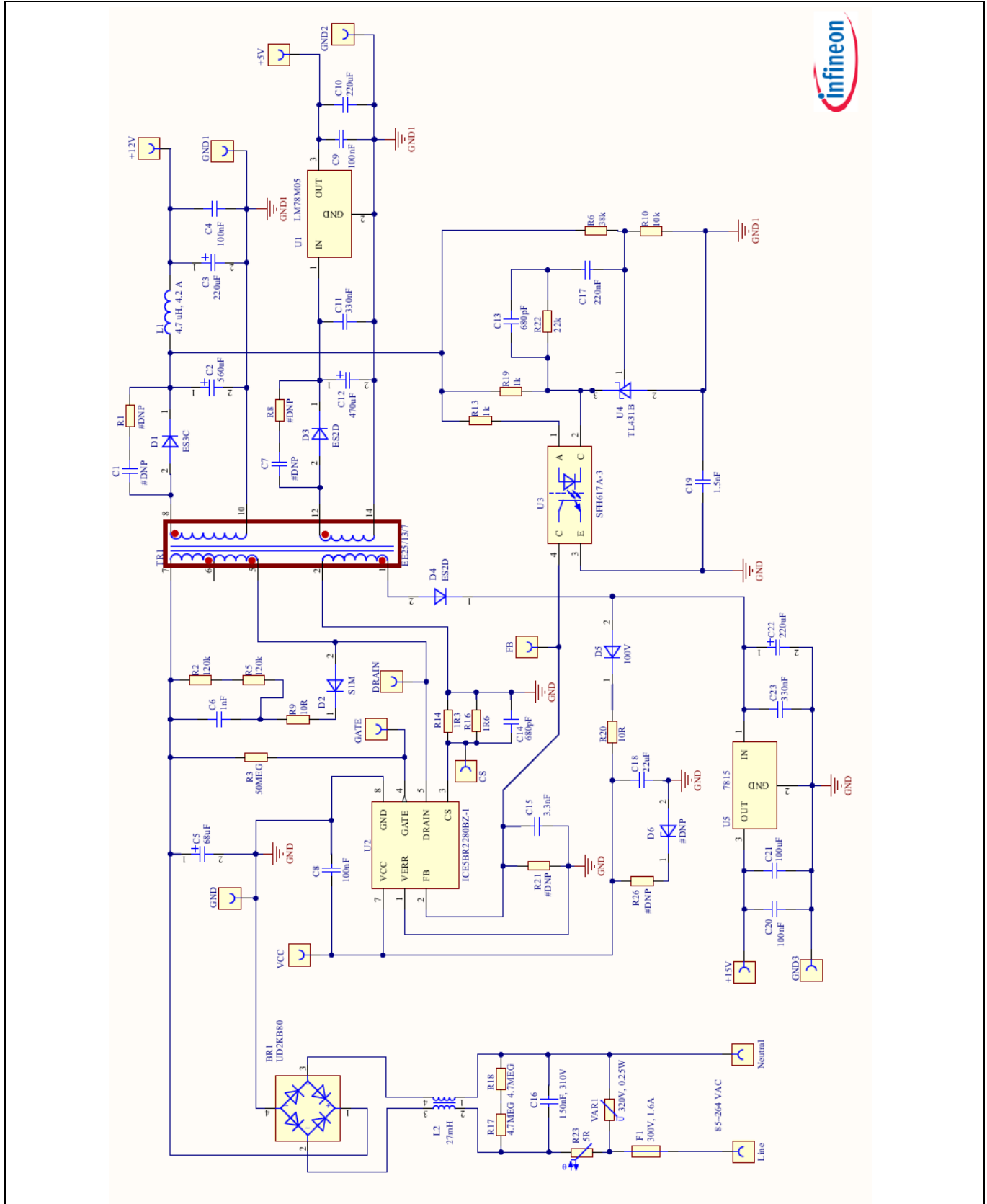

Figure 3 REF_5BR2280BZ-1_22W1

5 Circuit description

In this section, the design circuit for the SMPS unit will be briefly described by the different functional blocks. For details of the design procedure and component selection for the flyback circuitry, see the IC design guide [1] and calculation tool [3].

5.1 EMI filtering and line rectification

The input of the power supply unit is taken from the AC power grid, which is in the range of 85 V AC ~ 264 V AC. The fuse (F1) is directly connected to the input line to protect the system in case of excess current entering the system circuit due to any fault. Following is the varistor (VAR1), which is connected across the input to absorb excess energy during line-surge transient. The X-capacitor (C16) and common-mode choke (CMC) (L2) reduce the EMI noise. R17 and R18 serve as the X-capacitor discharge resistor. The bridge rectifier (BR1) rectifies the AC input into DC voltage, filtered by the bulk capacitor (C5).

5.2 Flyback converter power stage

The flyback converter power stage consists of a transformer (TR1), CoolSET™ switching controller, three secondary rectification diodes (D1, D3, and D4), secondary output capacitors (C2, C12, and C22), and an output filter inductor (L1).

When the primary HV MOSFET turns on, energy is stored in the transformer. When it turns off, the stored energy is discharged to the output capacitors and into the output load.

Secondary winding is sandwiched between two layers of primary winding to reduce leakage inductance. This improves efficiency and reduces voltage spikes.

For the output rectification, lower forward voltage and ultra-fast recovery diodes can improve efficiency. Capacitors (C2 and C12) store the energy needed during output load jumps. LC filter (L1/C3) reduces the high-frequency ripple voltage.

The +15 V output is from the 15 V low dropout (LDO) regulator (U5) with an input of +18 V, which also supplies V_{CC} . The +5 V output is from the 5 V LDO regulator (U1) with an input of +8 V. As such, these two outputs would not be affected by cross-regulation. However, their inputs should be maintained within the operating range of the LDO.

5.3 Control of flyback converter through CoolSET™ 5th Generation Fixed Frequency Plus ICE5BR2280BZ-1 switching controller

5.3.1 Current sensing

The ICE5BR2280BZ-1 is a current mode switching controller. The primary peak current is controlled cycle-by-cycle through the CS resistors (R14 and R16) in the CS pin (pin 4). Transformer saturation can be avoided through peak current limitation (PCL); therefore, the system is more protected and reliable.

5.3.2 Feedback and compensation network

Resistor dividers (R24 and R27) are used to sense the V_{out} and send the reference voltage to the feedback (FB) pin (pin 2) via an error amplifier TL431(U4) and an optocoupler (U3). A Type II compensation network (C13, C17, and R22) is implemented to stabilize the system.

22 W auxiliary power supply for indoor air conditioner using CoolSET™ ICE5BR2280BZ-1

REF_5BR2280BZ-1_22W1

Circuit description

The FB pin of the ICE5BR2280BZ-1 switching controller is a multifunction pin, which is used to select the entry burst power level (there are three levels available) through the resistor at the FB pin (R21) and also the burst-on/burst-off sense input during ABM.

5.4 Unique features

5.4.1 Fast self-start-up and sustaining of V_{CC}

The IC uses a cascode structure to fast-charge the V_{CC} capacitor. Pull-up resistors (R3, R6, and R10) connected to the GATE pin (pin 4) are used to initiate the start-up phase. At first, $I_{VCC_Charge1}$ is used to charge the V_{CC} capacitor from 0 V to V_{VCC_SCP} . This is a protection, which reduces the power dissipation of the power MOSFET during V_{CC} short-to-GND condition. Thereafter, a much higher charging current of $I_{VCC_Charge2}$ will charge the V_{CC} capacitor until the V_{VCC_ON} is reached.

After start-up, the IC V_{CC} supply is usually sustained by the auxiliary winding of the transformer, which needs to support the V_{CC} to be above undervoltage lockout (UVLO) voltage (10 V typ.). In this reference board, the V_{CC} supply is tapped from the +18 V winding.

5.4.2 CCM, DCM operation with frequency reduction

ICE5BR2280BZ-1 switching controller can be operated in either discontinuous conduction mode (DCM) or continuous conduction mode (CCM) with frequency-reduction features. This reference board is designed to operate in DCM at operating input voltage and load conditions. When the system is operating at a high output load, the controller will switch at 65 kHz. In order to achieve better efficiency between light load and medium load, frequency reduction is implemented as a function of V_{FB} , as shown in Figure 4. Switching frequency will not reduce further once the minimum switching frequency of 28 kHz is reached.

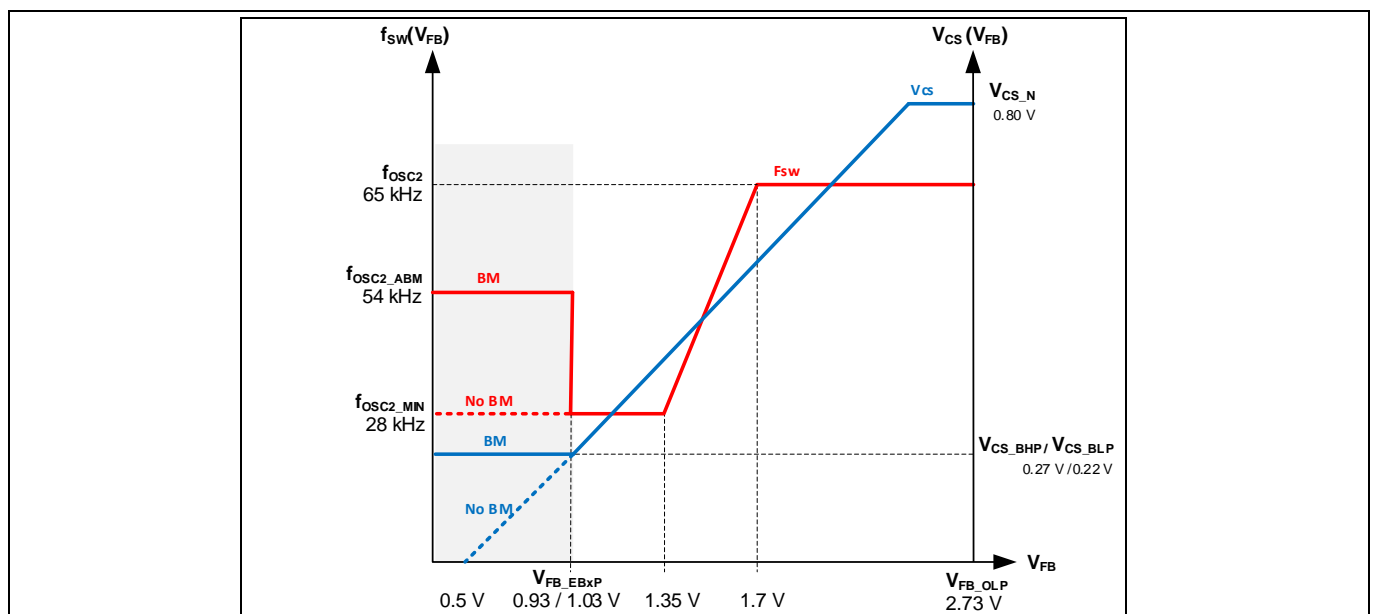

Figure 4 Frequency-reduction curve

22 W auxiliary power supply for indoor air conditioner using CoolSET™ ICE5BR2280BZ-1

REF_5BR2280BZ-1_22W1

Circuit description

5.4.3 Frequency jittering with modulated gate drive

ICE5BR2280BZ-1 switching controller has a frequency jittering feature with modulated gate drive to reduce the EMI noise. The jitter frequency is internally set at ± 4 percent of 65 kHz, and the jitter period is 4 ms.

5.4.4 System robustness and reliability through protection features

Protection is one of the major factors in determining whether the system is safe and robust – therefore, sufficient protection is necessary. ICE5BR2280BZ-1 switching controller provides comprehensive protection to ensure the system is operating safely. This includes V_{CC} overvoltage (OV) and undervoltage (UV), overload, overtemperature, and V_{CC} short-to-GND. When those faults are detected, the system will enter protection mode. Once the fault is removed, the system resumes normal operation. A list of protections and failure conditions is shown in [Table 3](#).

Table 3 Protection functions of ICE5BR2280BZ-1 switching controller

Protection function	Failure condition	Protection mode
V_{CC} OV	$V_{VCC} >$ greater than V_{VCC_OVp}	Extended cycle skip auto-restart
V_{CC} UV	$V_{VCC} <$ V_{VCCoff}	Auto-restart
Overload	$V_{FB} >$ V_{FB_OLP} and lasts for $t_{FB_OLP_B}$	Extended cycle skip auto-restart
Overtemperature	T_J greater than T_{jcon_OTP} (T_{jHYS_OTP} hysteresis)	Non-switch auto-restart
V_{CC} short-to-GND ($V_{VCC} = 0$ V, start-up = 50 m Ω and $V_{DRAIN} = 90$ V)	$V_{VCC} <$ V_{VCC_SCP} , $I_{VCC_Charge1} \approx -0.2$ mA (typ.)	No start-up

5.5 Clamper circuit

A clamper network, a diode, capacitor, and resistor (D2, C6, R2, R5, R9) are used to reduce the switching voltage spikes across the DRAIN pin of the integrated HV MOSFET of the CoolSET™ switching controller, which are generated by the leakage inductance of the transformer (TR1). This is a dissipative circuit; therefore, R2 and R5, and C6 need to be fine-tuned depending on the voltage derating factor and efficiency requirement.

5.6 PCB design recommendations

Following are the recommendations for a good PCB design layout:

- The switching power loop needs to be as small as possible (see [Figure 5](#)). There are four power loops in the reference design; one on the HV side and three on the output side. The HV side loop starts from the bulk capacitor (C5) positive terminal, primary transformer winding (pin 7 and pin 5 of TR1), CoolSET™ switching controller, CS resistors, and back to the C5 negative terminal.
 - The first output side loop (12 V output) starts at the transformer winding (pin 8 of TR1), output diode (D1), output capacitor (C2), and back to pin 10 of TR1.
 - The second output side loop (8 V output) starts at the transformer winding (pin 12 of TR1), output diode (D3), output capacitor (C12), and back to pin 14 of TR1.
 - The third output side loop (18 V output) starts at the transformer winding (pin 1 of TR1), output diode (D4), output capacitor (C18), and back to pin 2 of TR1.

22 W auxiliary power supply for indoor air conditioner using CoolSET™ ICE5BR2280BZ-1

REF_5BR2280BZ-1_22W1

Circuit description

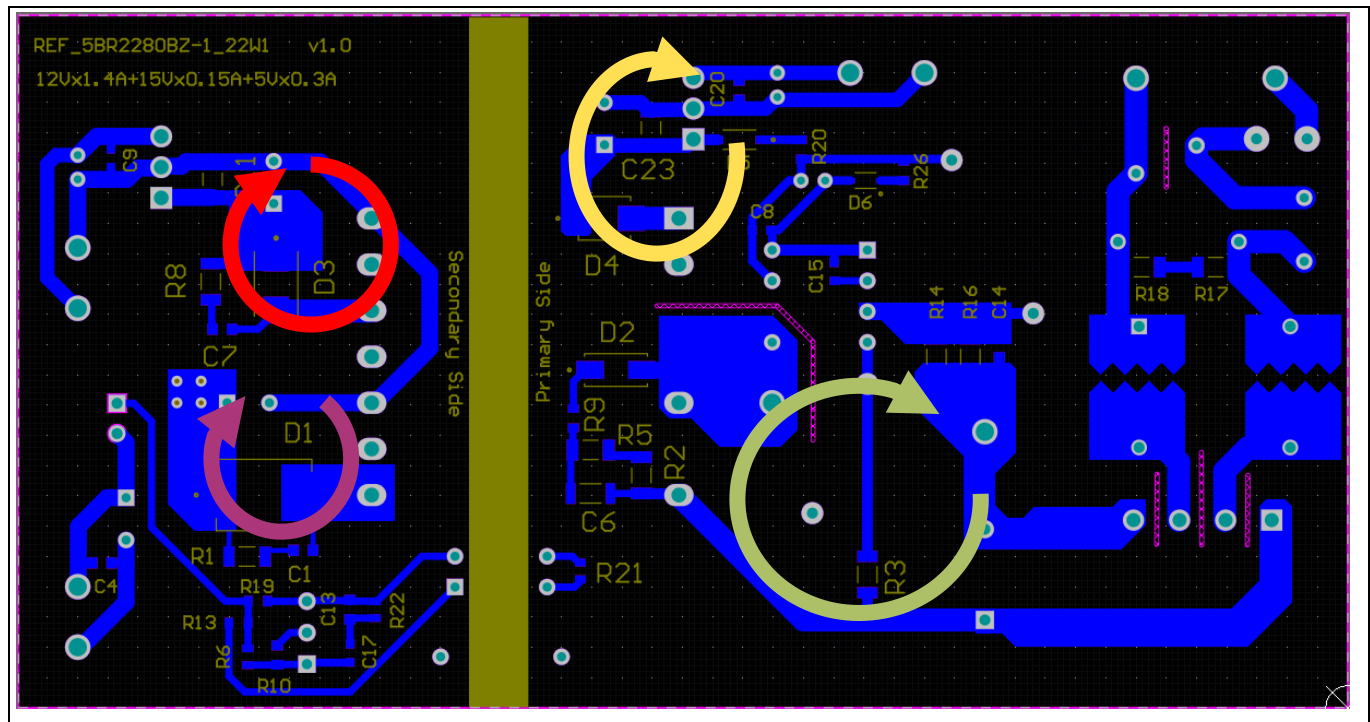

Figure 5 PCB layout tips

- Star-ground connection should be used to reduce high-frequency (HF) noise coupling that can affect the functional operation. The ground of the small-signal components should connect directly to the IC ground (pin 8 of U2).
- Separating the HV components and low voltage (LV) components, e.g., clamper circuit and main switching circuit can help reduce spark-over chance of the high energy surge during a lightning surge test.
- The PCB copper pour on the DRAIN pin of the MOSFET can act as a heatsink; thus, it can be widened if necessary.

22 W auxiliary power supply for indoor air conditioner using CoolSET™ ICE5BR2280BZ-1

REF_5BR2280BZ-1_22W1

PCB layout

6 PCB layout

6.1 Top side

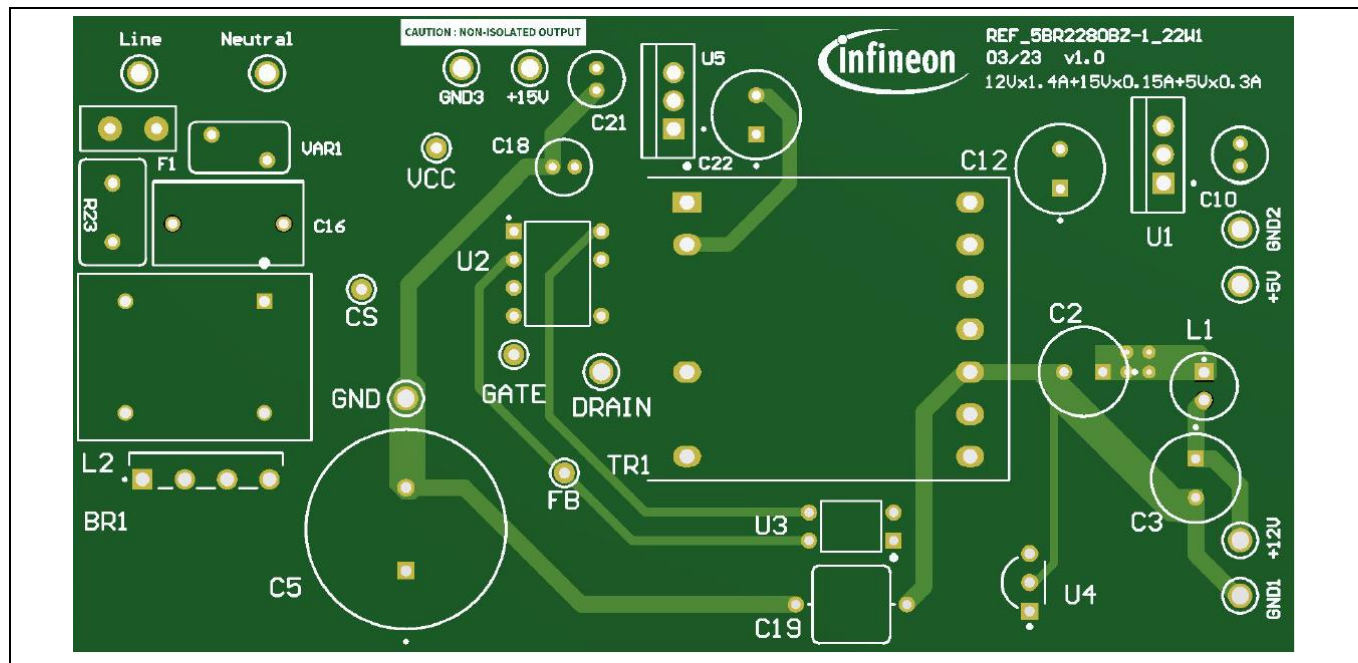

Figure 6 Top-side copper and component legend

6.2 Bottom side

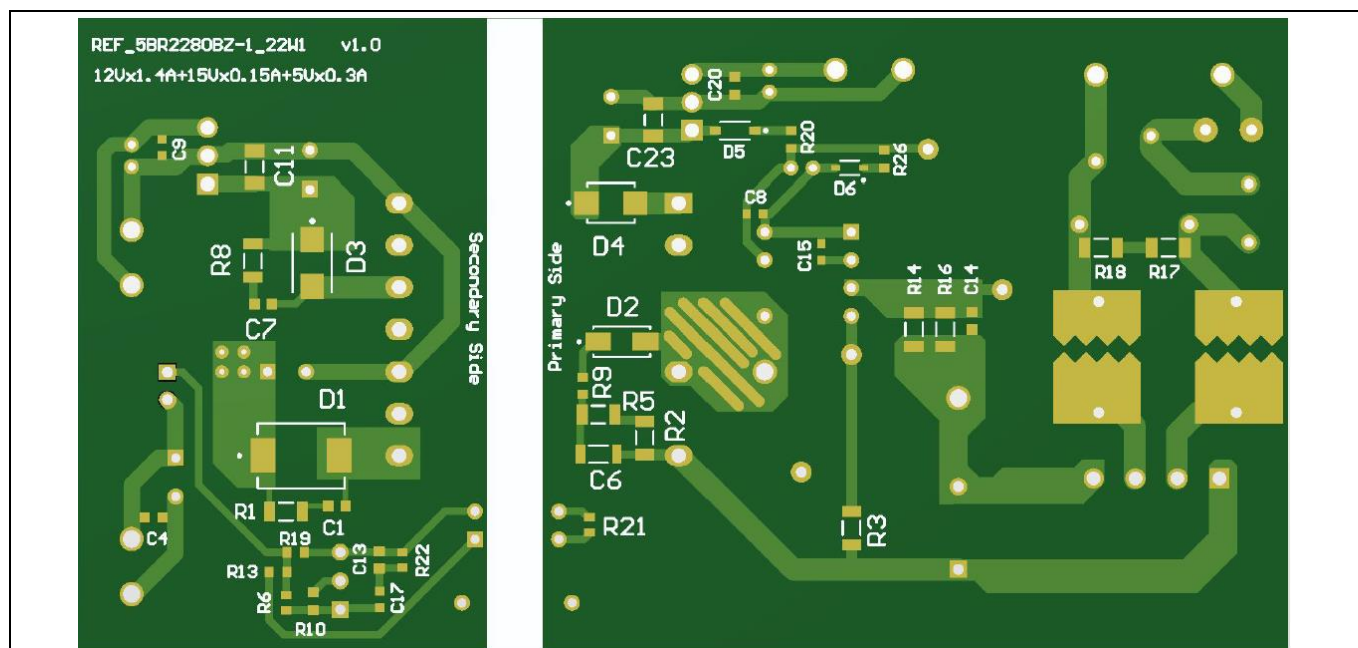

Figure 7 Bottom-side copper and component legend

22 W auxiliary power supply for indoor air conditioner using CoolSET™ ICE5BR2280BZ-1



REF_5BR2280BZ-1_22W1

Bill of materials

7 Bill of materials

Table 4 BOM

No.	Designator	Description	Manufacturer	Part number	Qty
1	BR1	Bridge Diode 800V, 2A	Shindengen	UD2KB80-7000	1
2	C2	CAP ALUM 560UF 20% 25V RADIAL	Rubycon	25ZLJ560M8X20	1
3	C3, C22	CAP ALUM 220UF 20% 35V RADIAL	Rubycon	35ZLH220MEFCT78X1 1.5	2
4	C4, C8, C9, C20	CAP CER 0.1UF 50V X7R 0603	-	-	4
5	C5	CAP ALUM 68UF 20% 400V RADIAL	Rubycon	400BXW68MEFC18X2 0	1
6	C6	CAP CER 1206 1NF 500V X7R 10% FL	-	-	1
7	C10, C21	CAP ALUM 100UF 20% 25V RADIAL	Rubycon	25PX100MEFC5X11	2
8	C11, C23	CAP CER 0.33UF 50V X7R 1206	-	-	2
9	C12	CAP ALUM 470UF 20% 16V T/H	Rubycon	16ZLJ470M8X11.5	1
10	C13, C14	CAP CER 0603 680PF 50V X7R 10%	-	-	2
11	C15	CAP CER 0603 3.3NF 50V X7R 10%	-	-	1
12	C16	CAP FILM 0.15UF 10% 310VAC RADIAL	Würth Elektronik	890334023025	1
13	C17	CAP CER 0.22UF 50V X7R 0603	-	-	1
14	C18	CAP ALUM 22UF 20% 35V RADIAL	UVR1V220MDD	Nichicon	1
15	C19	CAP CER 1500PF 250V RADIAL	Murata	DE1E3KX152MA4BN0 1F	1
16	D1	DIODE GEN PURP 150V 3A SMC	ON Semiconductor	ES3C	1
17	D2	DIODE GEN PURP 1KV 1A SMA	ON Semiconductor	S1M	1
18	D3, D4	DIODE GEN PURP 150V 2A DO214AA	ON Semiconductor	ES2C	2
19	D5	DIODE GEN PURP 100V 150MA SOD123	Diodes Incorporated	BAV16W-7-F	1
20	F1	Time Lag Fuse, 300V, 1.6A	Littelfuse	36911600000	1
21	L1	Inductor WE-TI, size 5075, 4.7 uH, 4.2 A	Würth Elektronik	7447462047	1
22	L2	CMC 27MH 700MA 2LN TH	TDK	B82731M2701A030	1
23	R2, R5	RES SMD 120K OHM 1% 1/4W 1206	-	-	2
24	R3	RES SMD 50M OHM 1% 1206	Vishay	CRHA1206AF50M0FKE F	3
25	R6	RES 38K OHM 1% 1/10W 0603	-	-	1
26	R9, R20	RES SMD 10 OHM 1% 1/10W 0603	-	-	2

22 W auxiliary power supply for indoor air conditioner using CoolSET™ ICE5BR2280BZ-1



REF_5BR2280BZ-1_22W1

Bill of materials

No.	Designator	Description	Manufacturer	Part number	Qty
27	R10	RES 10K OHM 1% 1/10W 0603	-	-	1
28	R14	RES SMD 1.3 OHM 1% 1/4W 1206	-	-	1
29	R16	RES SMD 1.6 OHM 1% 1/4W 1206	-	-	1
30	R13, R19	RES SMD 1K OHM 1% 1/8W 0603	-	-	2
31	R17, R18	RES SMD 4.7M OHM 1% 1/4W 1206	-	-	2
32	R22	RES 22K OHM 1% 1/10W 0603	-	-	1
33	R23	ICL 5 OHM 20% 4.2A 9.5MM	TDK	B57235S0509M000	1
34	TR1	EE25/13/7	Würth Elektronik	750344864	1
35	U1	L7805	STMicroelectronics	L7805ABV	1
36	U2	CoolSET™ 5 th Generation Fixed Frequency Plus 800 V	Infineon	ICE5BR2280BZ-1	1
37	U3	Optocoupler 5300 VRMS	Vishay	SFH617A-3	1
38	U4	IC VREF SHUNT 36V 0.4% TO92-3	ON Semiconductor	TL431BVLPG	1
39	U5	L7815	STMicroelectronics	L7815ABV	1
40	VAR1	S07K320E2/320VAC/10%	Epcos	B72207S2321K101	1
41	+15V, +5V, +12V, DRAIN, Neutral	Test Point THT, Red	Keystone	5010	5
42	CS, FB, GATE, VCC	Test Point THT, White	Keystone	5002	4
43	GND, GND1, GND2, GND3, Line	Test Point THT, Black	Keystone	5011	5

22 W auxiliary power supply for indoor air conditioner using CoolSET™ ICE5BR2280BZ-1

REF_5BR2280BZ-1_22W1

Transformer specification

8 Transformer specification

Core name and material: EE25/13/7, TP4A (TDG)

Primary inductance: $L_p = 630 \mu\text{H}$ (± 10 percent), measured between pin 5 and pin 7

Manufacturer and part number: Würth Elektronik (750344864) Rev. 01

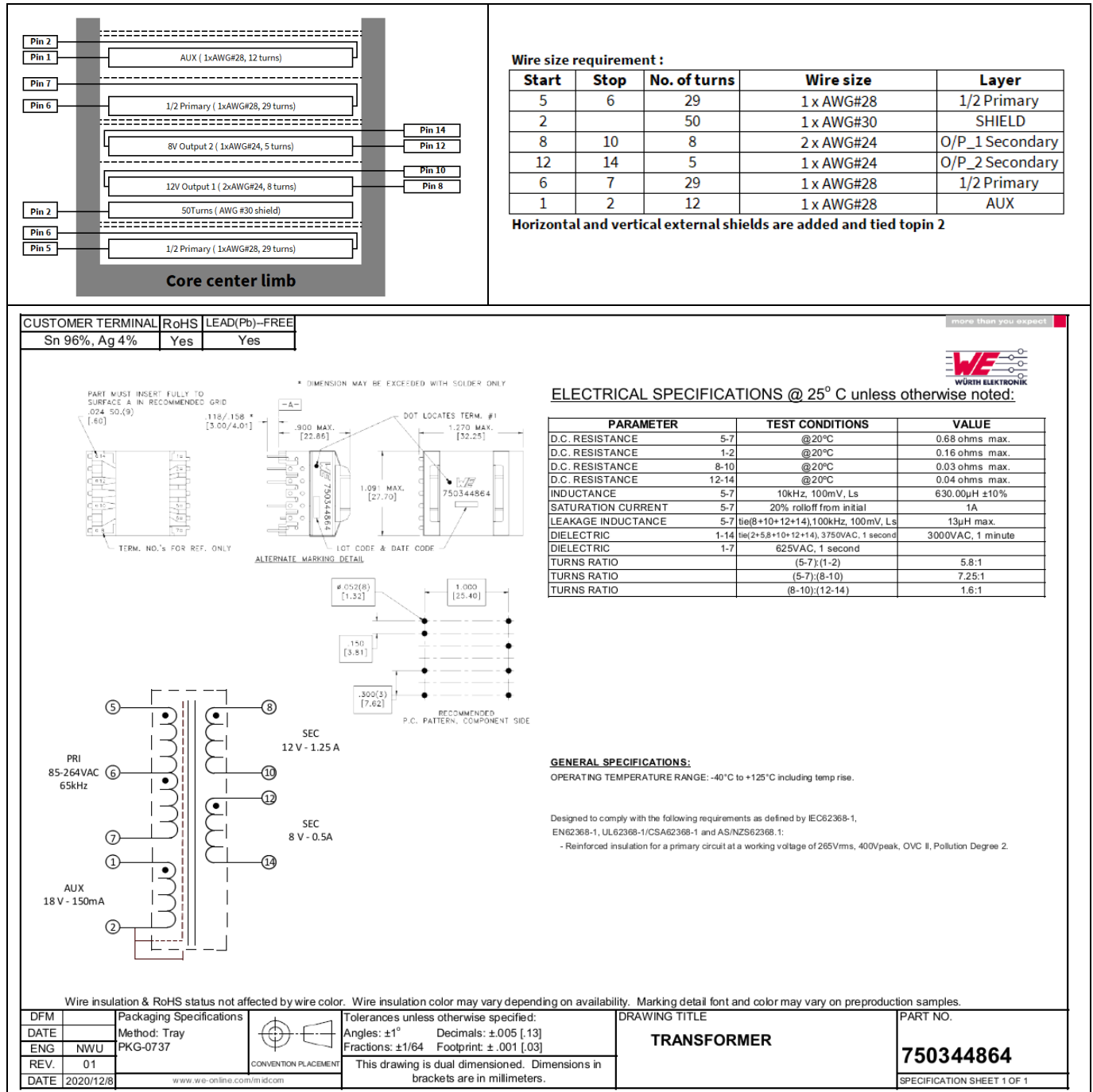

Figure 8 Transformer structure

22 W auxiliary power supply for indoor air conditioner using CoolSET™ ICE5BR2280BZ-1

REF_5BR2280BZ-1_22W1

Measurement data and graphs

9 Measurement data and graphs

Table 5 Electrical measurements

Input (V AC/Hz)	P _{IN} (W)	V _{O1} (V)	I _{O1} (A)	V _{O2} (V)	I _{O2} (A)	V _{O3} (V)	I _{O3} (A)	P _{OUT} (W)	Efficiency (%)	Average efficiency (%)	OLP P _{IN} (W)	OLP I _{O1} (A) 5 V/0.3 A 15 V/0.15 A
85 V AC/ 60 Hz	0.289	11.997	0.00	5.067	0.005	15.109	0.005	/	/	/	32.94	1.82
	6.539	11.990	0.35	5.062	0.075	15.078	0.038	5.14	78.63%	78.14%		
	13.076	11.977	0.70	5.060	0.150	15.059	0.075	10.27	78.56%			
	19.700	11.970	1.05	5.057	0.226	15.043	0.113	15.40	78.19%			
	26.580	11.962	1.40	5.052	0.300	15.050	0.150	20.52	77.20%			
115 V AC/ 60 Hz	0.291	11.997	0.00	5.067	0.005	15.109	0.005	/	/	/	32.03	1.82
	6.468	11.990	0.35	5.062	0.075	15.078	0.038	5.14	79.49%	79.51%		
	12.882	11.977	0.70	5.060	0.150	15.059	0.075	10.27	79.74%			
	19.346	11.970	1.05	5.057	0.226	15.043	0.113	15.40	79.62%			
	25.920	11.962	1.40	5.052	0.300	15.050	0.150	20.52	79.17%			
230 V AC/ 50 Hz	0.322	11.997	0.00	5.067	0.005	15.109	0.005	/	/	/	31.11	1.81
	6.541	11.990	0.35	5.062	0.075	15.078	0.038	5.14	78.61%	80.03%		
	12.887	11.977	0.70	5.060	0.150	15.059	0.075	10.27	79.71%			
	19.070	11.970	1.05	5.057	0.226	15.043	0.113	15.40	80.77%			
	25.320	11.962	1.40	5.052	0.300	15.050	0.150	20.52	81.04%			
264 V AC/ 50 Hz	0.326	11.997	0.00	5.067	0.005	15.109	0.005	/	/	/	31.57	1.84
	6.638	11.990	0.35	5.062	0.075	15.078	0.038	5.14	77.46%	79.60%		
	12.874	11.977	0.70	5.060	0.150	15.059	0.075	10.27	79.79%			
	19.130	11.970	1.05	5.057	0.226	15.043	0.113	15.40	80.52%			
	25.450	11.962	1.40	5.052	0.300	15.050	0.150	20.52	80.63%			

Minimum load condition: 12 V/0 A, 5 V/5 mA, 15 V/5 mA

25 percent load condition: 12 V/0.35 A, 5 V/75 mA, 15 V/37.5 mA

50 percent load condition: 12 V/0.70 A, 5 V/150 mA, 15 V/75 mA

75 percent load condition: 12 V/1.05 A, 5 V/225 mA, 15 V/112.5 mA

100 percent load condition: 12 V/1.4 A, 5 V/300 mA, 15 V/150 mA

22 W auxiliary power supply for indoor air conditioner using CoolSET™ ICE5BR2280BZ-1



REF_5BR2280BZ-1_22W1

Measurement data and graphs

Table 6 Single-output electrical measurements

Input (V AC/Hz)	P _{IN} (W)	V _{o1} (V)	I _{o1} (A)	P _{OUT} (W)	Efficiency (%)	Average efficiency (%)
85 V AC/ 60 Hz	0.039	12.000	0.00			82.34%
	5.059	11.990	0.35	4.20	82.95%	
	10.115	11.980	0.70	8.39	82.91%	
	15.320	11.970	1.05	12.57	82.04%	
	20.550	11.960	1.40	16.74	81.48%	
115 V AC/ 60 Hz	0.040	12.000	0.00			83.54%
	5.017	11.990	0.35	4.20	83.65%	
	9.973	11.980	0.70	8.39	84.09%	
	15.081	11.970	1.05	12.57	83.34%	
	20.156	11.960	1.40	16.74	83.07%	
230 V AC/ 50 Hz	0.050	12.000	0.00			83.55%
	5.076	11.990	0.35	4.20	82.67%	
	10.093	11.980	0.70	8.39	83.09%	
	14.930	11.970	1.05	12.57	84.18%	
	19.880	11.962	1.40	16.75	84.24%	
264 V AC/ 50 Hz	0.056	12.000	0.00			83.16%
	5.144	11.990	0.35	4.20	81.58%	
	10.097	11.980	0.70	8.39	83.05%	
	14.984	11.970	1.05	12.57	83.88%	
	19.910	11.962	1.40	16.75	84.11%	

Note: Single-output (+12 V) efficiency measurement was done by removing two LDO regulators and adding a Zener clamp circuit (R26 = 10 Ω, D6 = 22 V Zener). The reference board is not optimized for single-output configuration. The above efficiency data is for illustration only.

9.1 Efficiency curve

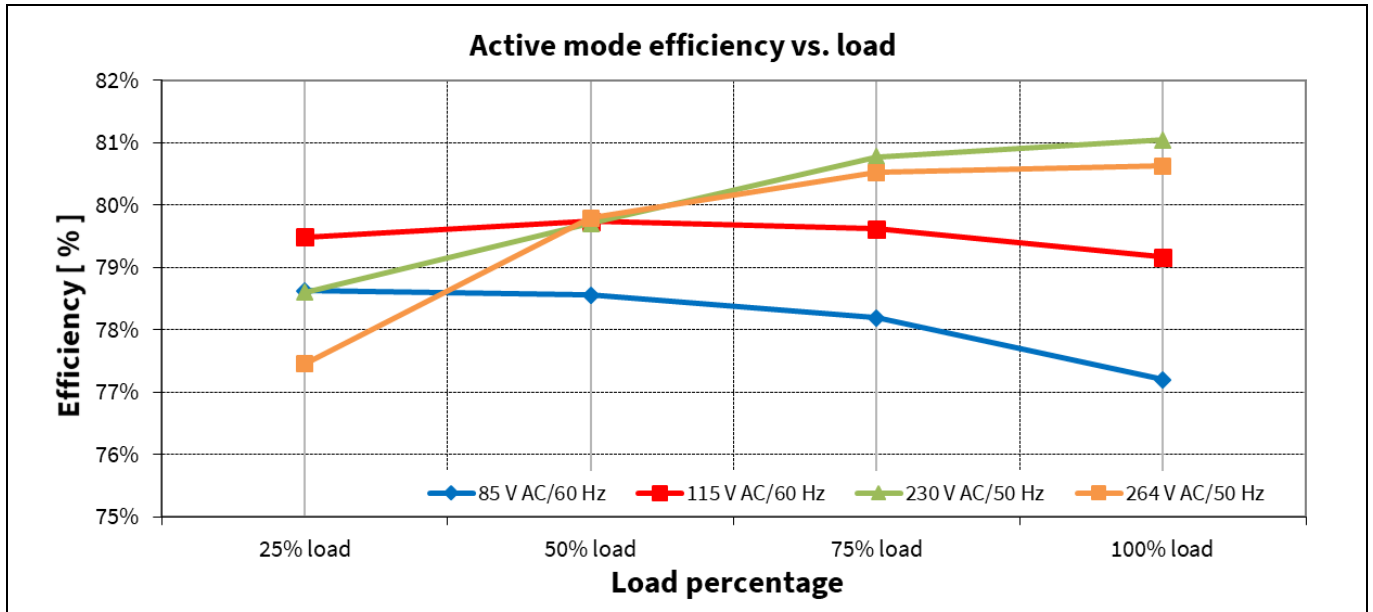

Figure 9 Efficiency vs. output load

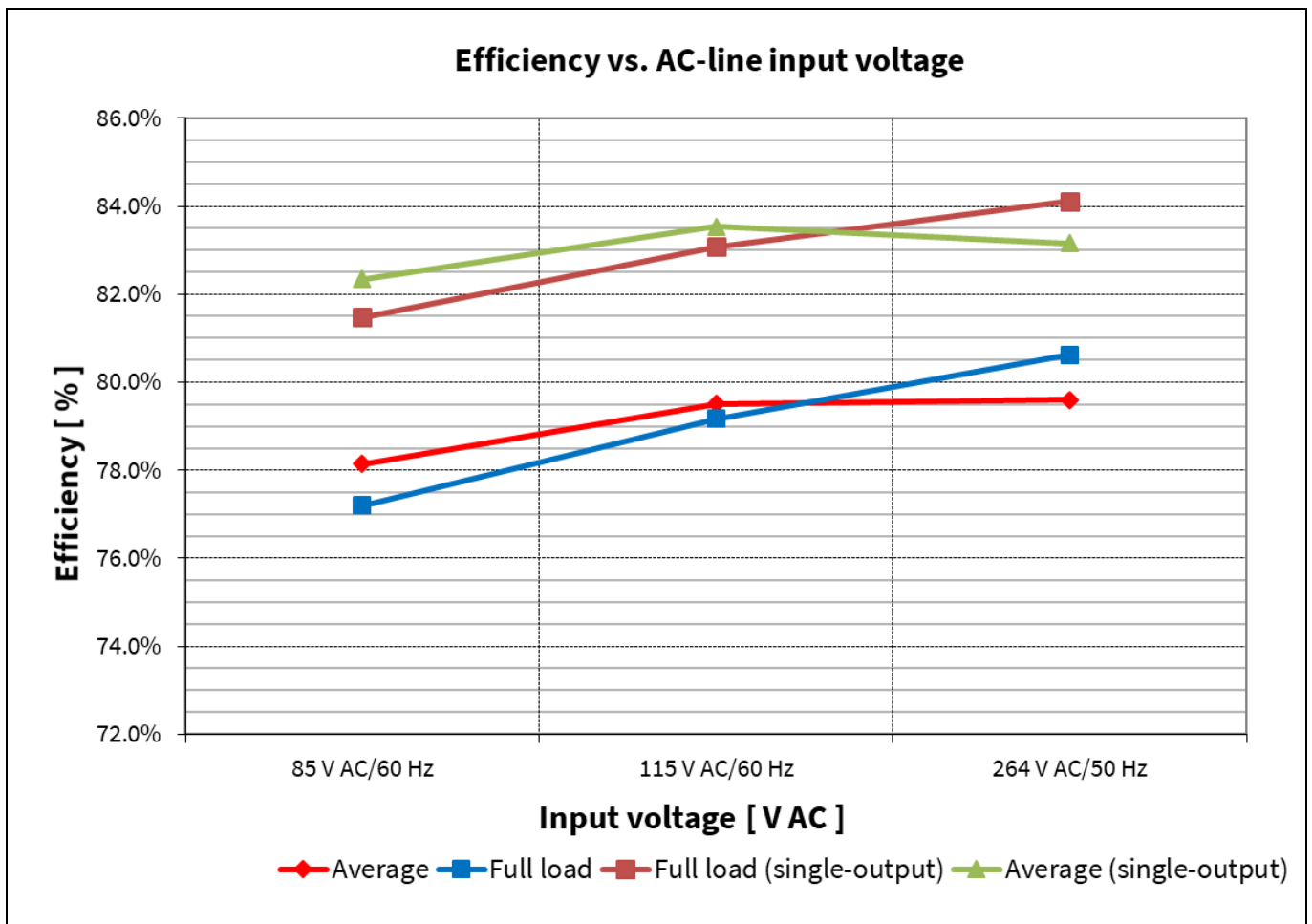

Figure 10 Efficiency vs. AC-line input voltage

22 W auxiliary power supply for indoor air conditioner using CoolSET™ ICE5BR2280BZ-1

REF_5BR2280BZ-1_22W1

Measurement data and graphs

9.2 Standby power

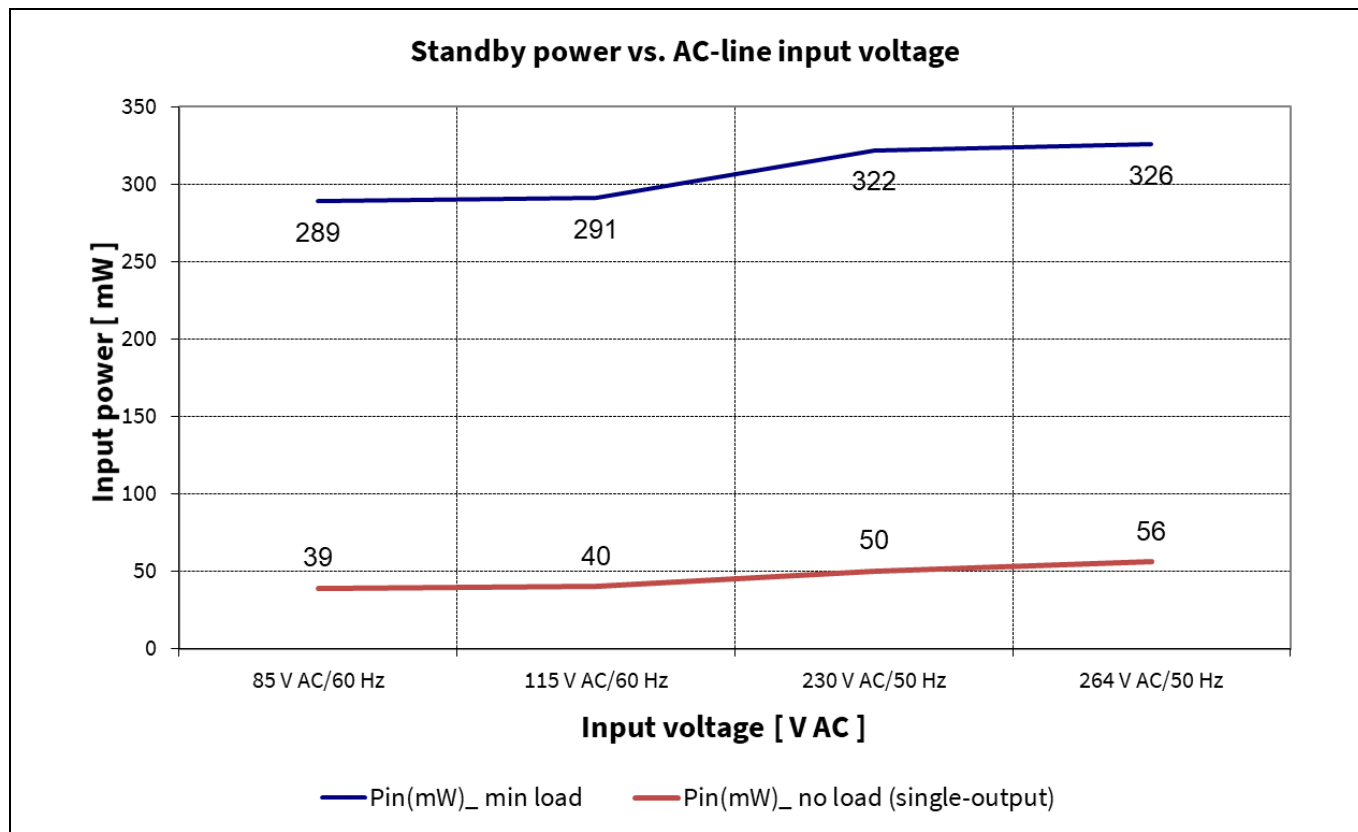

Figure 11 Standby power vs. AC-line input voltage

9.3 Line and load regulation

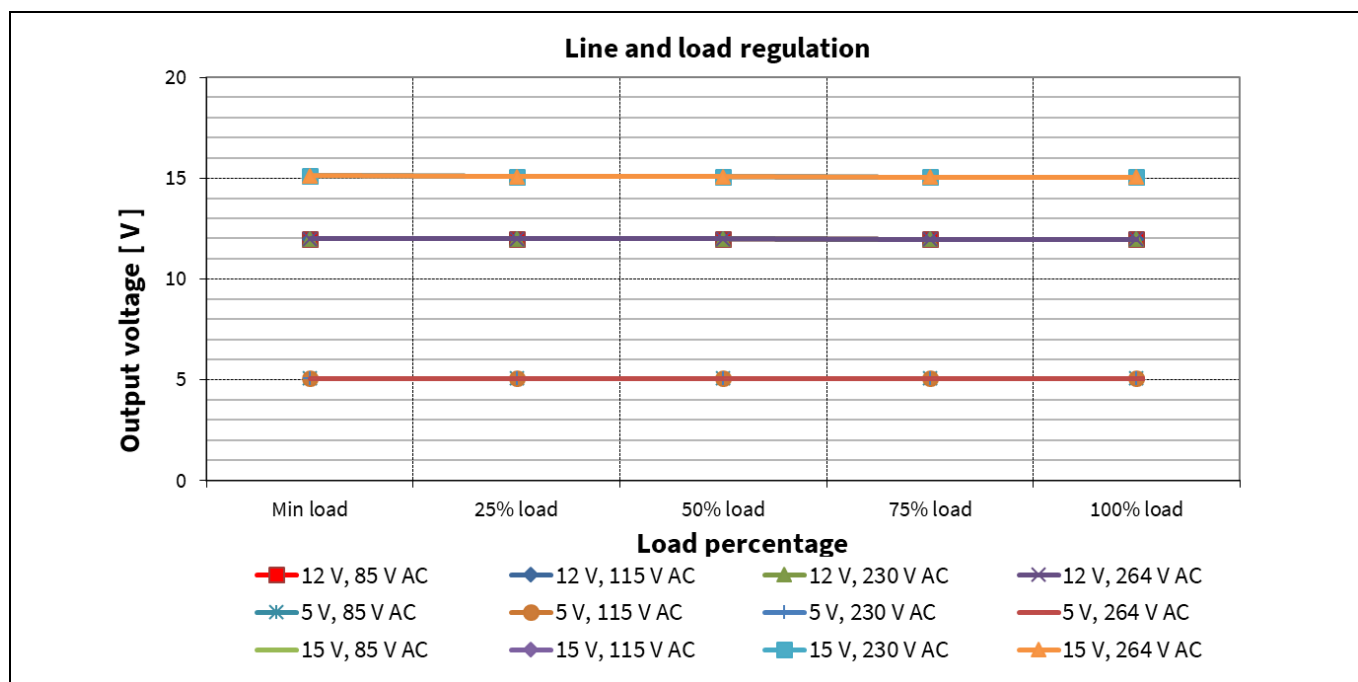

Figure 12 Line and load regulation

22 W auxiliary power supply for indoor air conditioner using CoolSET™ ICE5BR2280BZ-1

REF_5BR2280BZ-1_22W1

Measurement data and graphs

9.4 Maximum input power

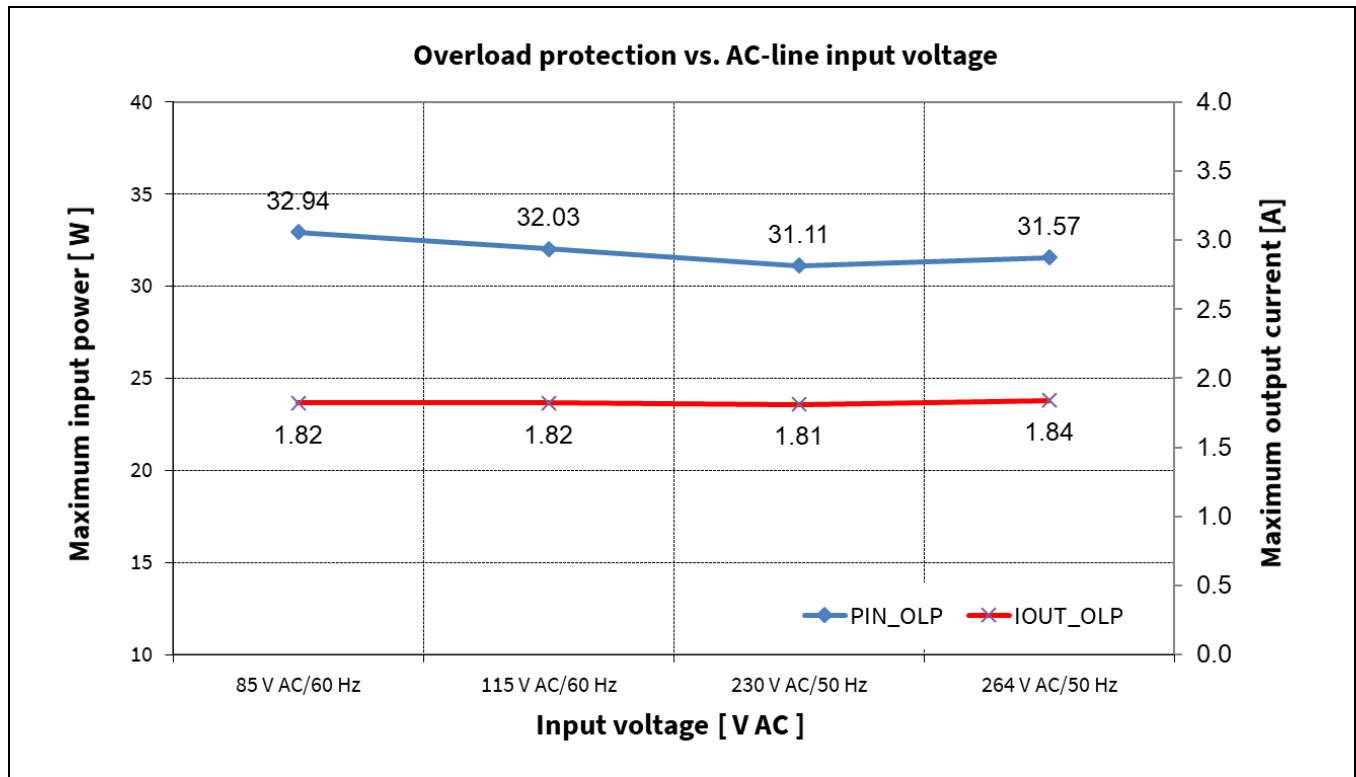

Figure 13 Maximum input power and 12 V output current before overload protection vs. AC-line input voltage (5 V/300 mA and 15 V/150 mA)

9.5 ESD immunity (EN 61000-4-2)

The system was subjected to a ± 8 kV air and ± 6 kV contact discharge ESD test according to EN 61000-4-2. A test failure was defined as non-recoverable.

Table 7 System ESD test result

Description	ESD test	Level	Number of strikes			Test result
			V _{O1}	V _{O2}	GND1	
115 V AC, 22 W	Contact	± 6 kV	10	10	10	Pass
	Air	± 8 kV	10	10	10	Pass
230 V AC, 22 W	Contact	± 6 kV	10	10	10	Pass
	Air	± 8 kV	10	10	10	Pass

22 W auxiliary power supply for indoor air conditioner using CoolSET™ ICE5BR2280BZ-1

REF_5BR2280BZ-1_22W1

Measurement data and graphs

9.6 Surge immunity (EN 61000-4-5)

The reference board was subjected to a surge immunity test (± 2 kV DM and ± 4 kV CM) according to EN 61000-4-5. It was tested at full load (resistive load). A test failure was defined as non-recoverable.

Table 8 System surge immunity test result

Description	Test	Level		Number of strikes				Test result
				0°	90°	180°	270°	
115 V AC	DM	± 2 kV	L \rightarrow N	3	3	3	3	Pass
	CM	± 4 kV	L \rightarrow G	3	3	3	3	Pass
		± 4 kV	N \rightarrow G	3	3	3	3	Pass
230 V AC	DM	± 2 kV	L \rightarrow N	3	3	3	3	Pass
	CM	± 4 kV	L \rightarrow G	3	3	3	3	Pass
		± 4 kV	N \rightarrow G	3	3	3	3	Pass

9.7 Conducted emissions (EN 55022 Class-B)

The conducted EMI was measured by Schaffner (SMR4503) and followed the test standard of EN 55022 (CISPR 22) Class-B. The reference board was tested at full load (resistive load) at input voltage of 115 V AC and 230 V AC.

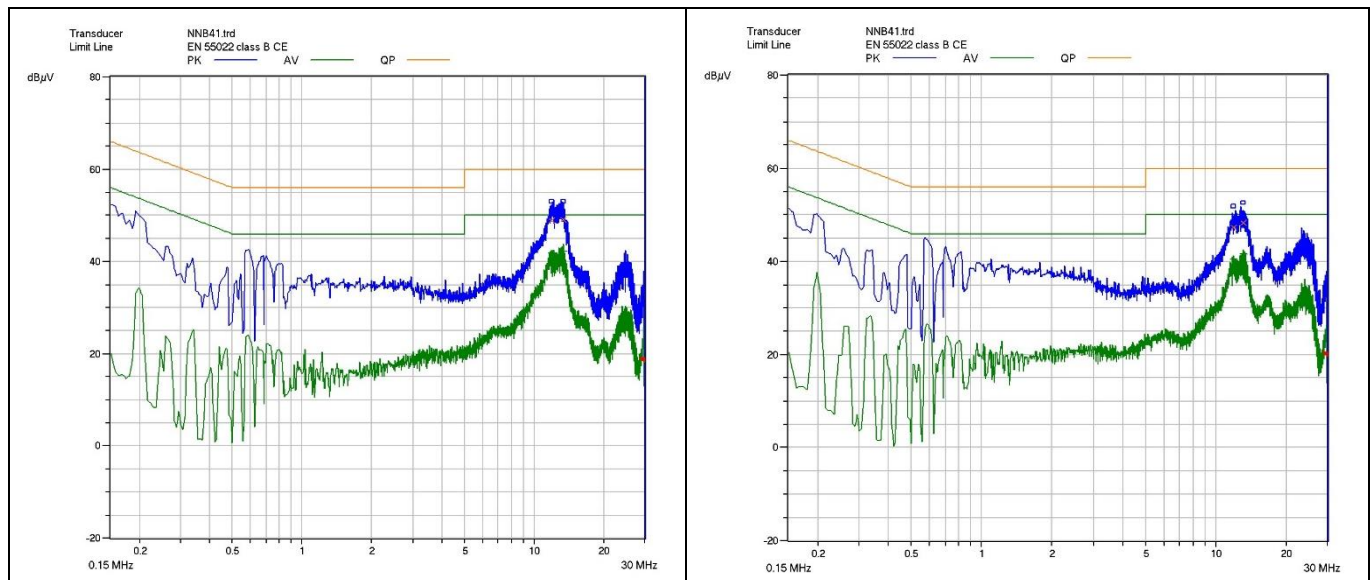

Figure 14 Conducted emissions at 115 V AC and full load on line (left) and neutral (right)

22 W auxiliary power supply for indoor air conditioner using CoolSET™ ICE5BR2280BZ-1

REF_5BR2280BZ-1_22W1

Measurement data and graphs

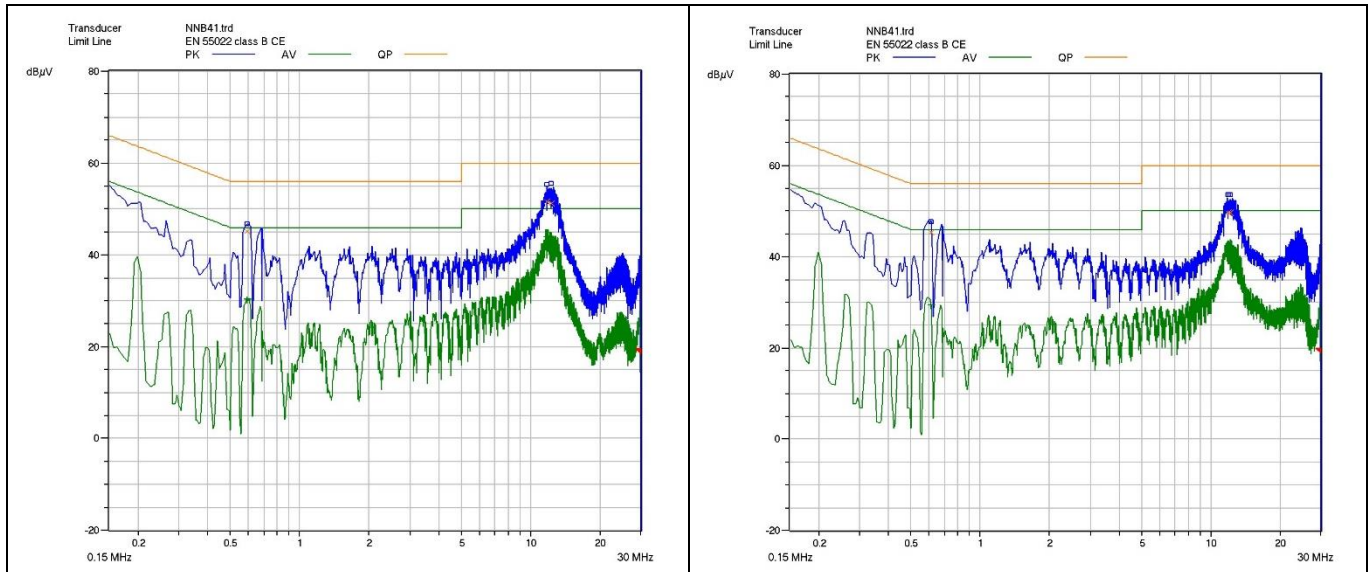

Figure 15 Conducted emissions at 230 V AC and full load on line (left) and neutral (right)

9.8 Thermal measurement

Thermal measurement was done by using an infrared thermography camera (FLIR-T62101) at an ambient temperature of 25°C taken after one hour running at full load. The temperature of the components was taken in an open-frame set-up.

Table 9 Thermal measurement of components (open-frame)

No.	Components	Temperature at 85 V AC (°C)	Temperature at 264 V AC (°C)
1	U2 (ICE5BR2280BZ-1)	73.6	68.8
2	U5 (L7815)	71.2	69.4
3	U1 (L7805)	73.6	68.1
4	TR1 (transformer)	56.3	57.6
5	D1 (output 1 diode)	91.3	90.4
6	D3 (output 2 diode)	67.0	67.6
7	D4 (output 3 diode)	63.8	63.9

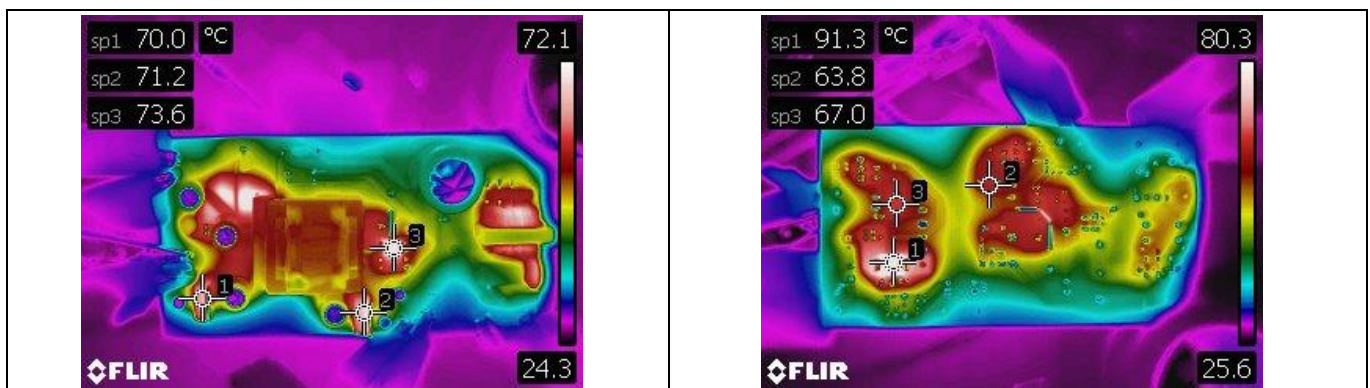

Figure 16 Top-side (left) and bottom-side (right) thermal image at 85 V AC input voltage

22 W auxiliary power supply for indoor air conditioner using CoolSET™ ICE5BR2280BZ-1

REF_5BR2280BZ-1_22W1

Measurement data and graphs

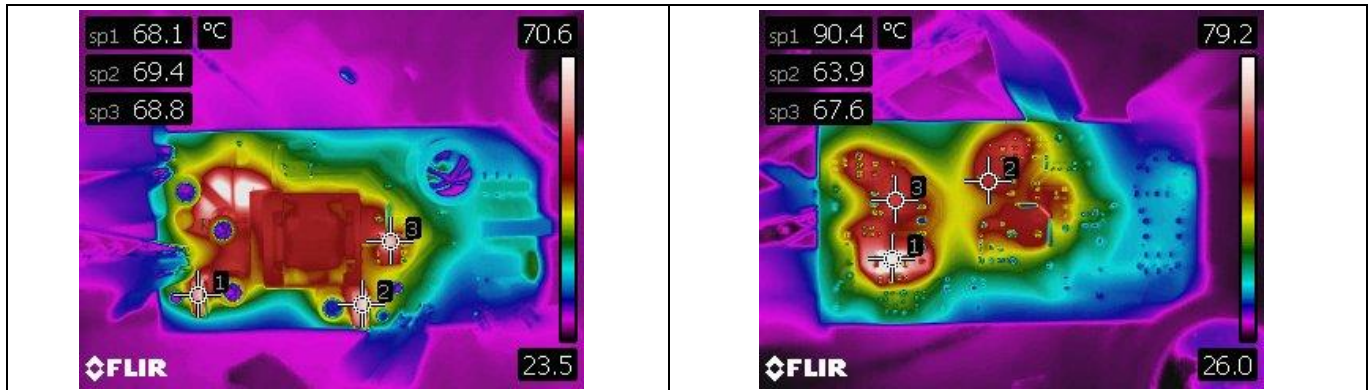

Figure 17 Top-side (left) and bottom-side (right) thermal image at 264 V AC input voltage

9.9 +18 V rail regulation (LDO input)

As the +15 V output via LDO is derived from the +18 V rail from the transformer which is also shared by the CoolSET™ V_{CC} , there are several design goals during normal operating conditions:

- Avoid V_{CC} UVLO (10 V Typ.)
- Avoid V_{CC} OVP (25.5 V Typ.)
- Meet the specification of the LDO: $(V_{out} + 1\sim 2\text{ V}) \leq V_{IN} \leq 30\text{ V}$; load dependent

In [Figure 18](#) and [Table 10](#), the +18 V rail is operating between 16.2 V and 23.90 V under different load combination and line conditions, which is well within the design objectives outlined above.

Table 10 +18 V rail line and load regulation

Conditions	12 V/0 A 5 V/0 A 15 V/0 A (V)	12 V/0 mA 5 V/5 mA 15 V/5 mA (V)	12 V/1.4 A 5 V/5 mA 15 V/5 mA (V)	12 V/1.4 A 5 V/0.3 A 15 V/0.15 A (V)
85 V AC/60 Hz	16.87	16.22	23.75	18.34
115 V AC/60 Hz	16.86	16.20	23.90	18.32
230 V AC/50 Hz	16.89	16.26	23.73	18.33
264 V AC/50 Hz	16.84	16.20	23.58	18.32

22 W auxiliary power supply for indoor air conditioner using CoolSET™ ICE5BR2280BZ-1

REF_5BR2280BZ-1_22W1

Measurement data and graphs

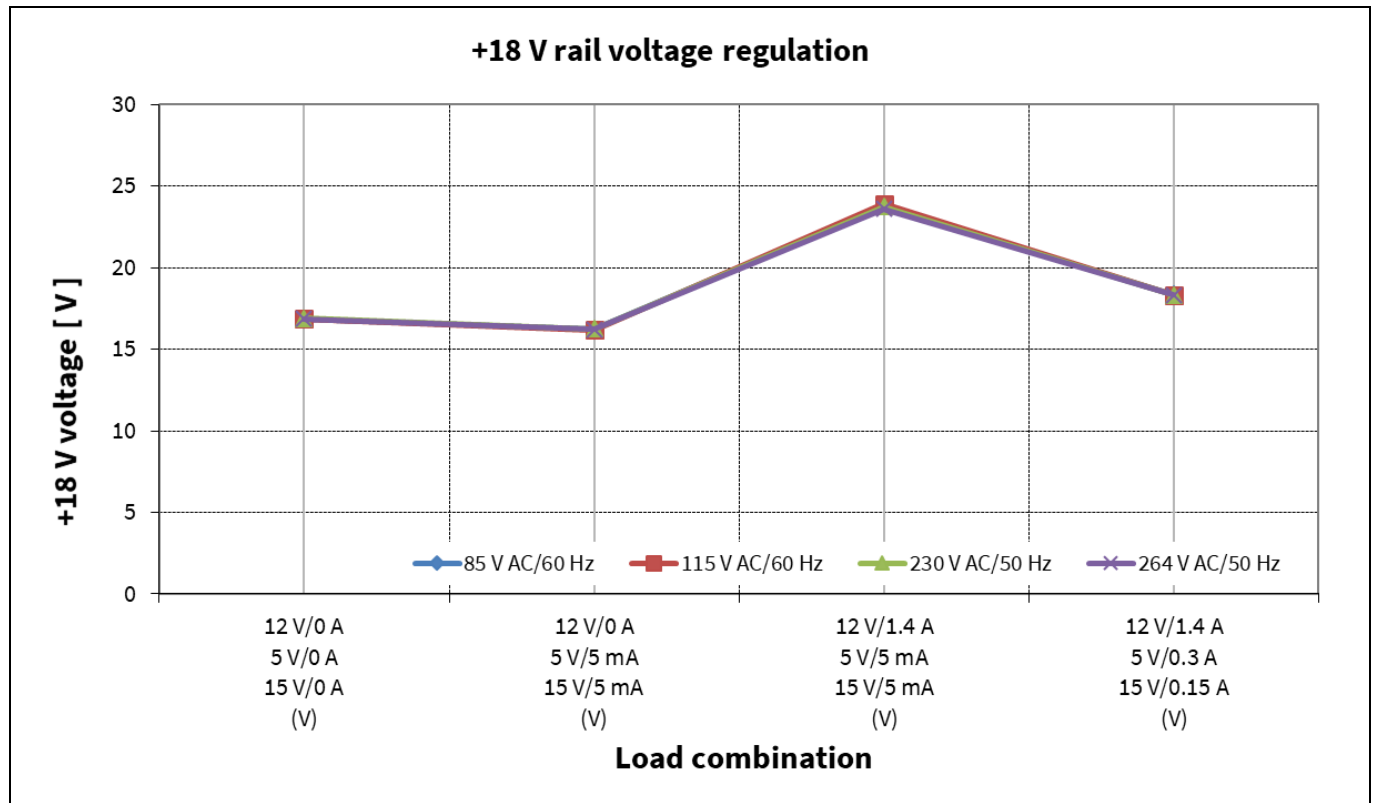

Figure 18 +18 V rail regulation

22 W auxiliary power supply for indoor air conditioner using CoolSET™ ICE5BR2280BZ-1

REF_5BR2280BZ-1_22W1

Waveforms and oscilloscope plots

10 Waveforms and oscilloscope plots

All waveforms and scope plots were recorded with a Teledyne LeCroy WaveRunner 8054 oscilloscope.

10.1 Start-up at full load

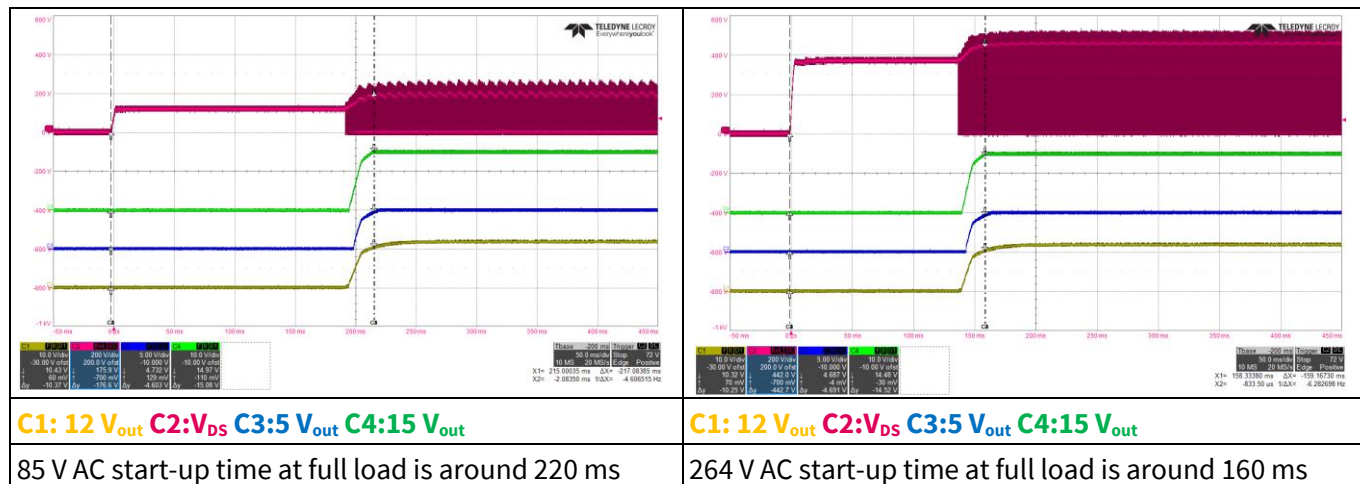

Figure 19 Start-up

10.2 Soft-start at full load

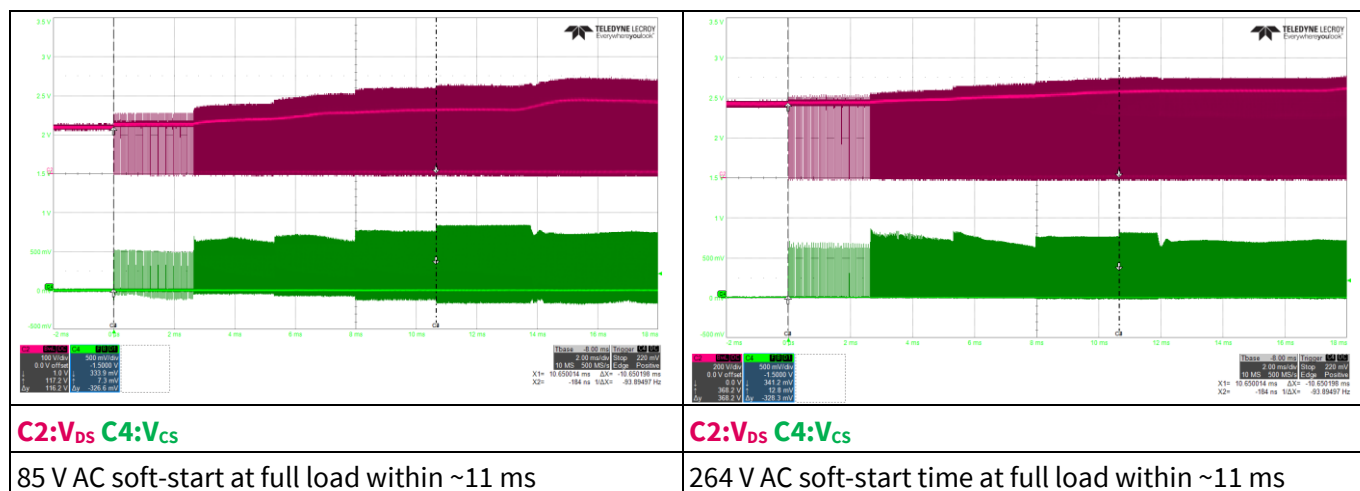

Figure 20 Soft-start

22 W auxiliary power supply for indoor air conditioner using CoolSET™ ICE5BR2280BZ-1

REF_5BR2280BZ-1_22W1

Waveforms and oscilloscope plots

10.3 Drain and CS voltage at full load

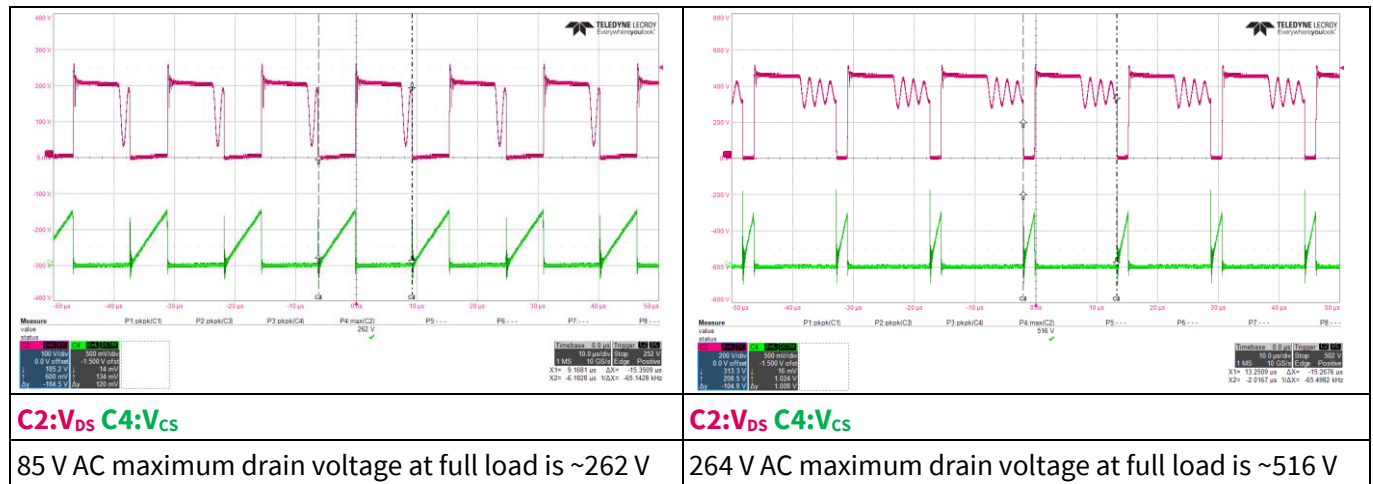

Figure 21 Drain and CS voltage

10.4 Frequency jittering

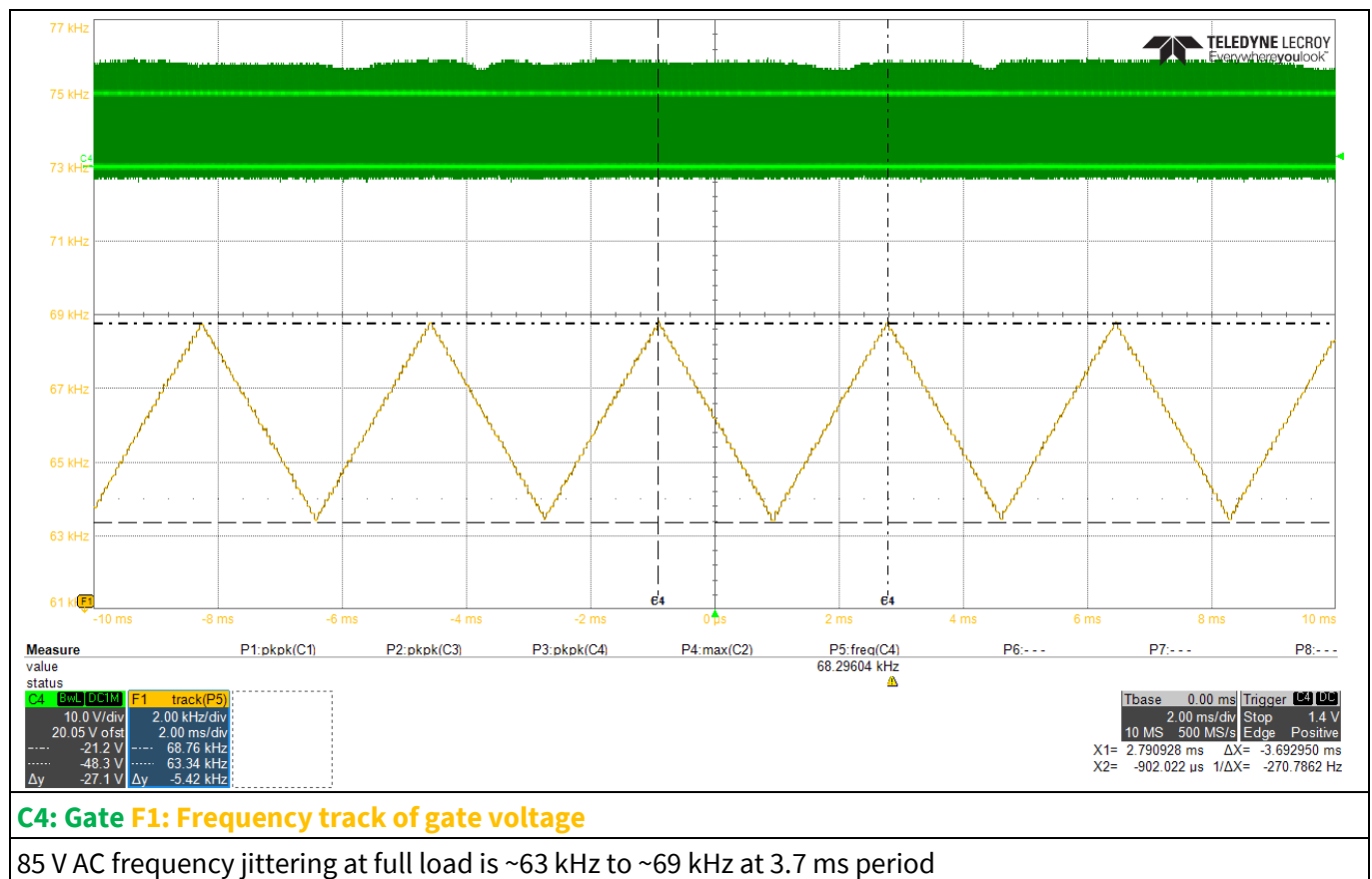

Figure 22 Frequency jittering

22 W auxiliary power supply for indoor air conditioner using CoolSET™ ICE5BR2280BZ-1

REF_5BR2280BZ-1_22W1

Waveforms and oscilloscope plots

10.5 Load-transient response

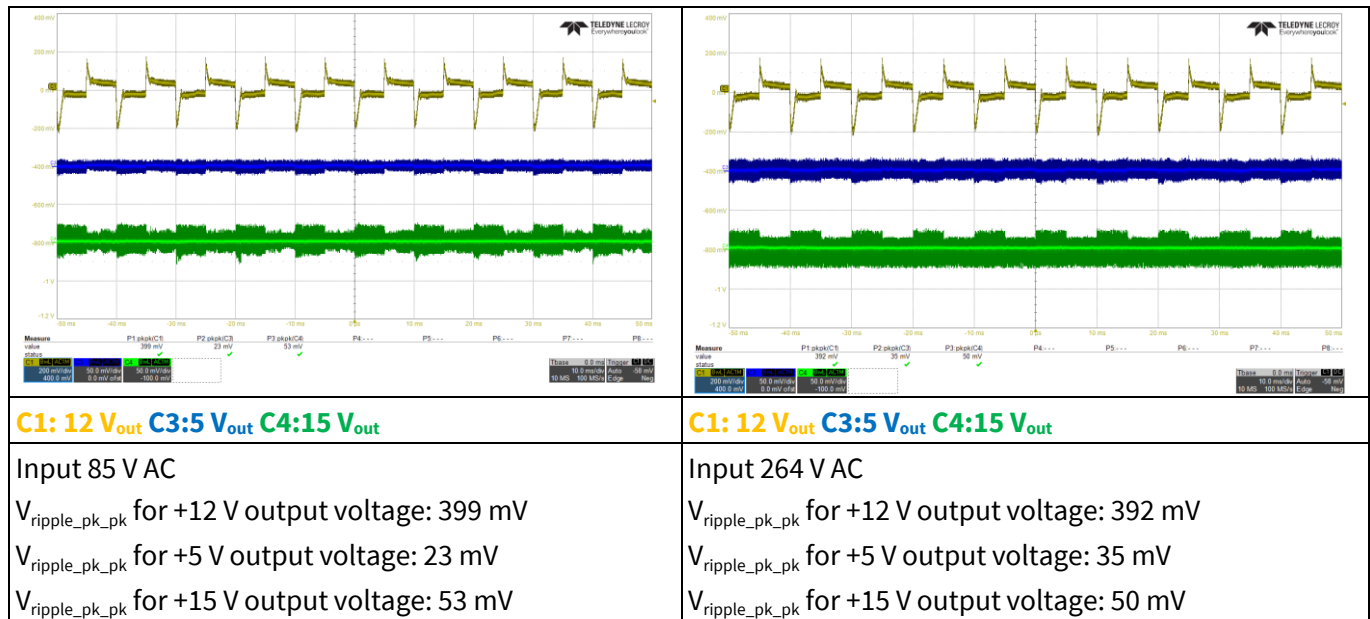

Figure 23 Load-transient response (+12 V output load change from 10 percent to 100 percent at 0.4 A/ μ s slew rate, 100 Hz, +15 V output, and +5 V output load are fixed at full load; 20 MHz bandwidth and 10 μ F electrolytic capacitor in parallel with 0.1 μ F ceramic capacitor)

10.6 Output ripple voltage at full load

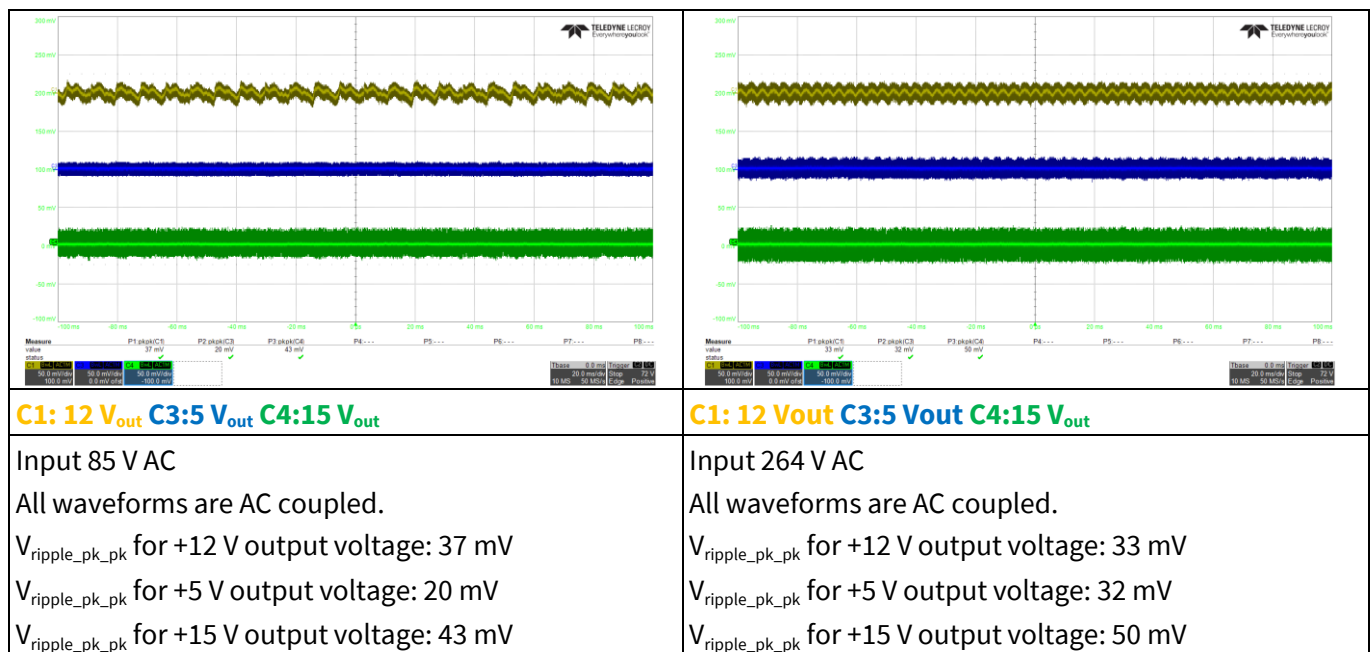

Figure 24 Output ripple voltage at full load (20 MHz bandwidth and 10 μ F electrolytic capacitor in parallel with 0.1 μ F ceramic capacitor)

22 W auxiliary power supply for indoor air conditioner using CoolSET™ ICE5BR2280BZ-1

REF_5BR2280BZ-1_22W1

Waveforms and oscilloscope plots

10.7 Output ripple voltage at ABM

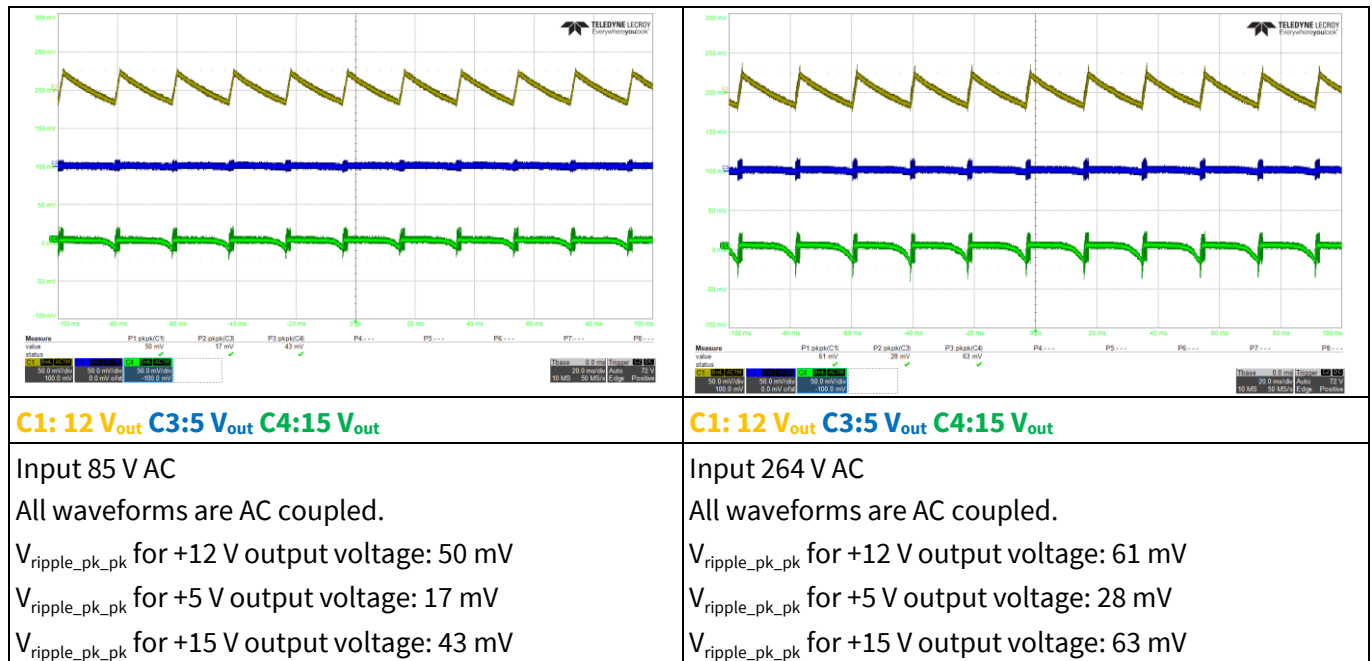

Figure 25 Output ripple voltage at ABM, minimum load (20 MHz bandwidth and 10 μF electrolytic capacitor in parallel with 0.1 μF ceramic capacitor)

10.8 Entering ABM

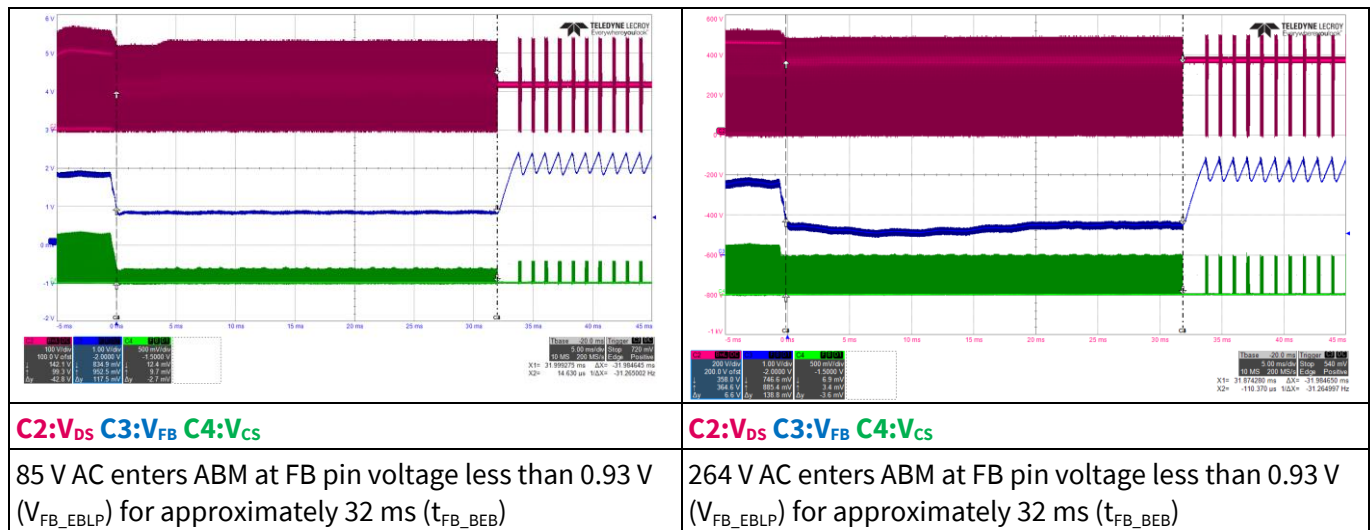

Figure 26 Entering ABM (+12 V output load change from 1.25 A to 50 mA; +15 V and +5 V outputs have minimum load)

22 W auxiliary power supply for indoor air conditioner using CoolSET™ ICE5BR2280BZ-1

REF_5BR2280BZ-1_22W1

Waveforms and oscilloscope plots

10.9 During ABM

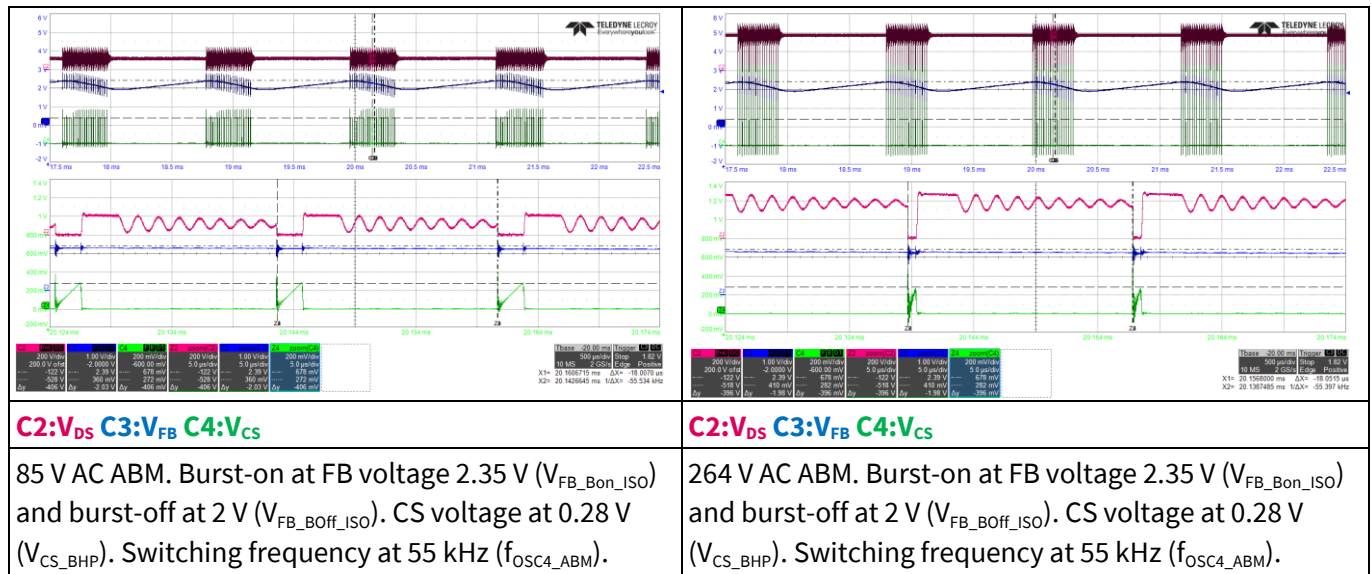

Figure 27 During ABM

10.10 Leaving ABM

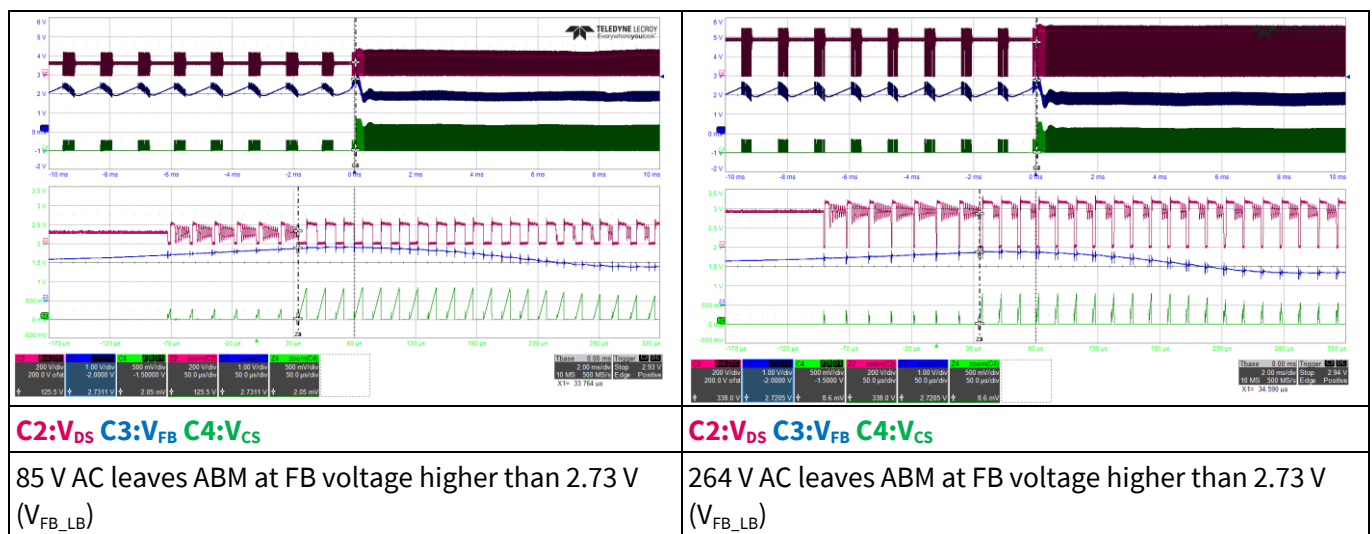

Figure 28 Leaving ABM (+12 V output load change from 50 mA to 1.4 A, +15 V, and +5 V outputs have minimum load)

22 W auxiliary power supply for indoor air conditioner using CoolSET™ ICE5BR2280BZ-1

REF_5BR2280BZ-1_22W1

Waveforms and oscilloscope plots

10.11 V_{CC} OV/UV protection

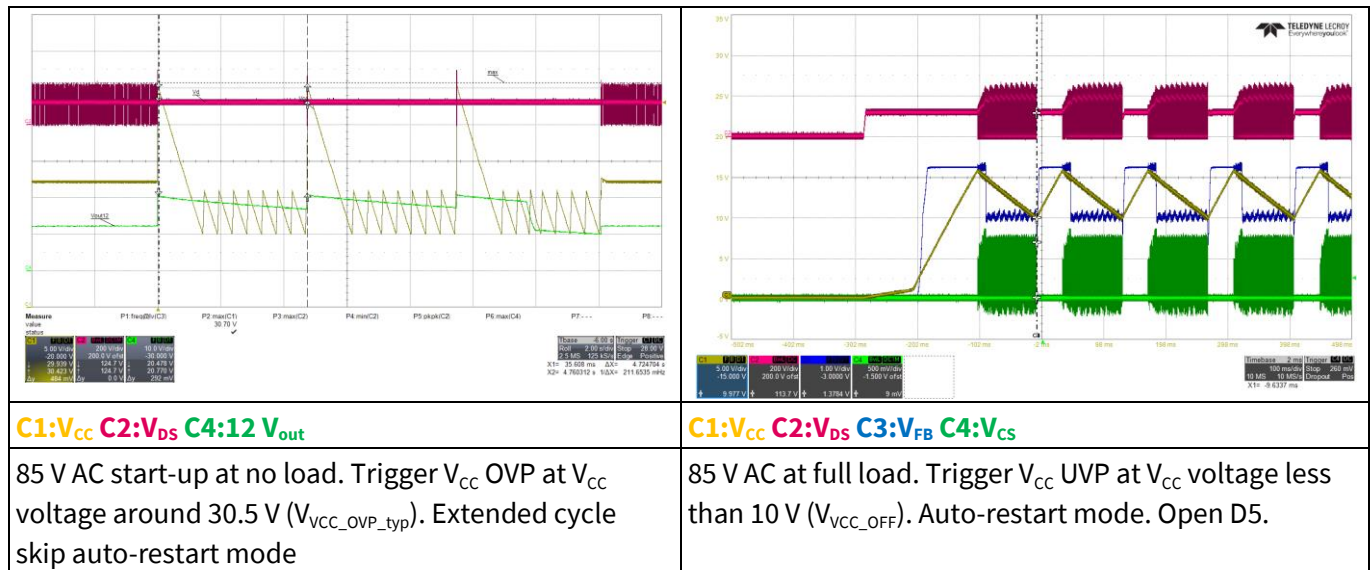

Figure 29 V_{CC} OV/UV protection

10.12 Overload protection

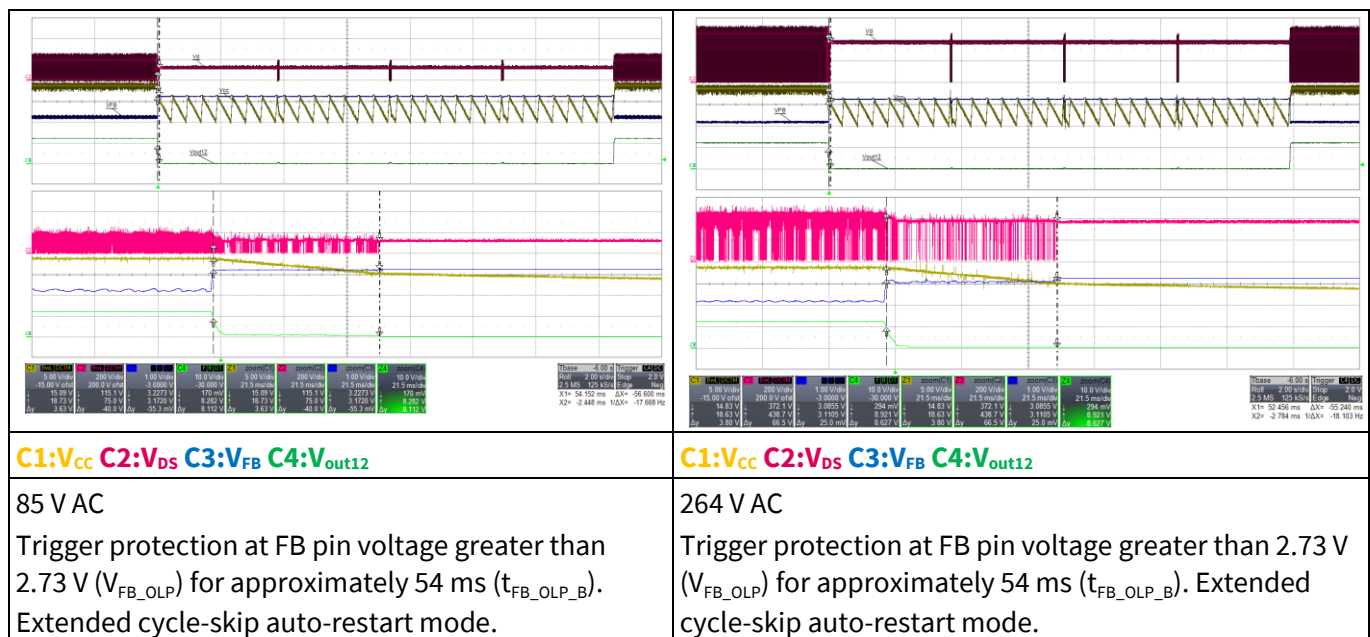

Figure 30 Overload protection (load increased at +12 V output from 1.4 A to 2 A to trigger protection; +15 V output and +5 V output fixed at full load)

22 W auxiliary power supply for indoor air conditioner using CoolSET™ ICE5BR2280BZ-1



REF_5BR2280BZ-1_22W1

References

References

- [1] Infineon Technologies AG: *ICE5xRxxxxBZx-1 datasheet*; [Available online](#)
- [2] Infineon Technologies AG: *CoolSET™ 5th Generation Fixed Frequency Plus flyback design guide*; [Available online](#)
- [3] Infineon Technologies AG: *CoolSET™ 5th Generation Fixed Frequency Plus calculation tool for flyback*; [Available online](#)

22 W auxiliary power supply for indoor air conditioner using CoolSET™ ICE5BR2280BZ-1

REF_5BR2280BZ-1_22W1

Design support

Design support

Developer community

For a wider discussion with peers from industry to trade ideas regarding Infineon products, we welcome you to actively participate on the [Infineon Developer Community](#).

Technical support

Have technical queries? Consult experts from Infineon to get a fast turn-around by request on the [Technical Support](#) page or a [local sales representative](#).

22 W auxiliary power supply for indoor air conditioner using CoolSET™ ICE5BR2280BZ-1



REF_5BR2280BZ-1_22W1

Revision history

Revision history

Document revision	Date	Description of changes
V 1.0	2024-08-23	Initial release

Trademarks

All referenced product or service names and trademarks are the property of their respective owners.

Edition 2024-08-23

Published by

Infineon Technologies AG

81726 Munich, Germany

**© 2024 Infineon Technologies AG.
All Rights Reserved.**

Do you have a question about this document?

Email: erratum@infineon.com

Document reference

AN074239

Important notice

The information contained in this application note is given as a hint for the implementation of the product only and shall in no event be regarded as a description or warranty of a certain functionality, condition or quality of the product. Before implementation of the product, the recipient of this application note must verify any function and other technical information given herein in the real application. Infineon Technologies hereby disclaims any and all warranties and liabilities of any kind (including without limitation warranties of non-infringement of intellectual property rights of any third party) with respect to any and all information given in this application note.

The data contained in this document is exclusively intended for technically trained staff. It is the responsibility of customer's technical departments to evaluate the suitability of the product for the intended application and the completeness of the product information given in this document with respect to such application.

Please note that this product is not qualified according to the AEC Q100 or AEC Q101 documents of the Automotive Electronics Council.

Warnings

Due to technical requirements products may contain dangerous substances. For information on the types in question please contact your nearest Infineon Technologies office.

Except as otherwise explicitly approved by Infineon Technologies in a written document signed by authorized representatives of Infineon Technologies, Infineon Technologies' products may not be used in any applications where a failure of the product or any consequences of the use thereof can reasonably be expected to result in personal injury.