



TAOGLAS®



Datasheet

Inception Series

Part No:
AHP5354A.07.0100C

Description

GNSS L1/L5 Active Patch with 2 Stage LNA & 100mm 1.37 and I-PEX MHFI(U,FL)

Features:

Low-profile Active Multiband GNSS Patch

Bands Covered:

- BeiDou (B1/B2a)
- GPS/QZSS (L1/L5)
- GLONASS (G1)
- Galileo (E1/E5a)

Dims: 70mm x 70mm x 9.3mm

Custom Cables and Connectors Available

RoHS & Reach Compliant

1.	Introduction	3
2.	Specification	4
3.	Mechanical Drawing	7
4.	Packaging	8
5.	Antenna Characteristics	9
6.	Radiation Patterns	14
7.	LNA Characteristics	19
<hr/>		
	Changelog	22

Taoglas makes no warranties based on the accuracy or completeness of the contents of this document and reserves the right to make changes to specifications and product descriptions at any time without notice. Taoglas reserves all rights to this document and the information contained herein. Reproduction, use or disclosure to third parties without express permission is strictly prohibited.

Ireland & USA
ISO 9001:2015
Certified



Taiwan
ISO 9001:2015
Certified



1. Introduction



The Taoglas **Inception Series AHP5354A**, is a multi-band GNSS, high-performance directional antenna for high precision GPS and BeiDou accuracy and fast positioning. It is the active version of the successful HP5354 Inception 'Patch within a Patch'. It utilizes the compact 35 x 35 x 4mm advanced wide-band ceramic patch antenna with optimized gain for GNSS bands. Bands covered include BeiDou (B1/B2a), GPS/QZSS (L1/L5), GLONASS (G1) and Galileo (E1/E5a).

Typical Applications Include:

- Autonomous Robotics
- Precision Agriculture
- Navigation & Transportation
- Autonomous Vehicles

The AHP5354A has been tuned and tested on a 70 x 70mm ground plane and exhibits excellent radiation patterns and tight axial ratio. The AHP5354A has been optimized to cover the bands required for the next generation of L1/L5 GNSS receivers that are currently on the market.

The AHP5354A has been designed to be a premium solution for high precision GNSS systems, by including the L5 Band for High Precision GNSS positioning. The active patch can be easily integrated into devices via the mounting holes on the corner of the PCB.

The AHP5354A comes with 100mm of 1.37 micro coax cable and an I-PEX® MHF-1 connector as standard but these are fully customizable to suit your specific application. For further information on how to integrate and test this antenna in your device please contact your regional Taoglas customer support team.

2. Specification

GNSS Frequency Bands					
GPS	L1 1575.42 MHz	L2 1227.6 MHz	L5 1176.45 MHz		
	■	□	■		
GLONASS	G1 1602 MHz	G2 1248 MHz	G3 1207 MHz		
	■	□	□		
Galileo	E1 1575.24 MHz	E5a 1176.45 MHz	E5b 1201.5 MHz	E6 1278.75 MHz	
	■	■	□	□	
BeiDou	B1C 1575.42 MHz	B1I 1561 MHz	B2a 1176.45 MHz	B2b 1207.14 MHz	B3 1268.52 MHz
	■	■	■	□	□
L-Band	L-Band 1542 MHz				
	□				
QZSS (Regional)	L1 1575.42 MHz	L2C 1227.6 MHz	L5 1176.45 MHz	L6 1278.75e6	
	■	□	■	□	
IRNSS (Regional)	L5 1176.45 MHz				
	■				
SBAS	L1/E1/B1 1575.42 MHz	L5/B2a/E5a 1176.45 MHz	G1 1602 MHz	G2 1248 MHz	G3 1207 MHz
	■	■	■	□	□

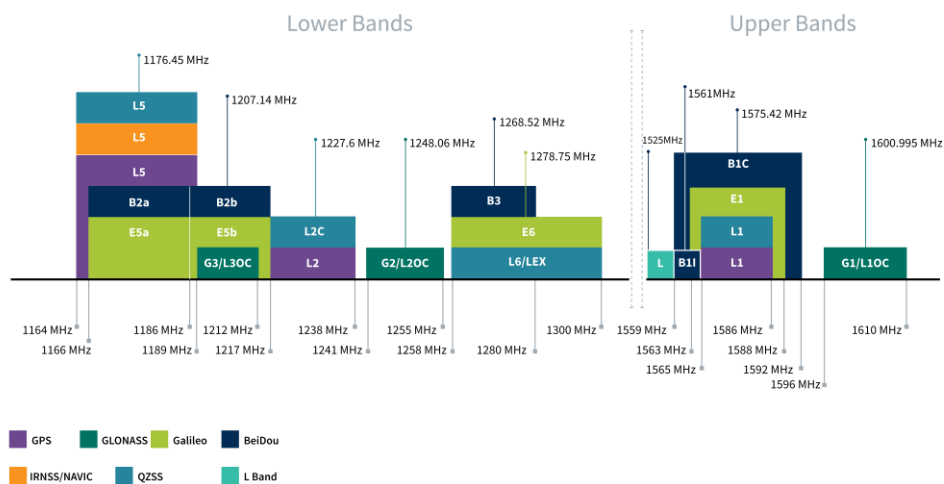

GNSS Bands and Constellations

GNSS Electrical				
Frequency (MHz)	GPS L5	BeiDou_B1	GPS_L1	GLONASS_G1
	1166-1186	1559-1563	1563-1587	1569-1610
VSWR (max.)	2:1	1:1		
Efficiency (%)	41.7	28.8	52.2	54.9
Average Gain (dB)	-3.80	-5.41	-2.83	-2.61
Peak Gain (dBi)	2.07	2.61	2.61	2.06
Axial Ratio (dB)	1.90	1.79	1.79	1.22
PCO_x (cm)	1.03	1.36	1.38	1.37
PCO_y (cm)	-0.24	-0.05	-0.11	-0.09
PCV (cm)	0.01	0.01	0.01	0.01
Group Delay Mean (ns)	22.70	13.56	15.58	13.36
Polarization	RHCP			
Impedance	50 Ω			

LNA and Filter Electrical Properties				
Frequency (MHz)	1176.45	1561	1575.42	1603
Gain (dB)	29.2	28.2	27.5	27.1
Noise Figure (dB)	2.4	2.4	2.4	2.5
Out Of Band Rejection	-50dB for frequencies <1GHz -70dB for frequencies >1.7GHz			
Current Consumption(mA)	5			
Voltage in (V)	+ 1.8 to 5.5			

Mechanical	
Dimensions	35 x 35 x 4 mm
Total Dimension (Including Shielding Case)	70 x 70 x 9mm
Weight	TBD
Material	Ceramic
Connector	IPEX MHFI (U.FL)
Cable	1.37mm Coaxial Cable

Environmental	
Operation Temperature	-40°C to 85°C
Storage Temperature	-40°C to 85°C
Relative Humidity	Non-condensing 65°C 95% RH

3. Mechanical Drawing

ISO NO.: EDW.000125

STATE: Release

NOTES:

- * All material must be RoHS compliant.
- * Use this drawing together with the corresponding 3D CAD database file to fully describe the part.
- * The connector orientation has a fixed position to the antenna as per drawing.
- ** Critical Dimensions.

REV	ZONE	DESCRIPTION	ENG	APPROVED	DATE
D01	All	initial	Aaron	Chozen	2023/8/17
D02	All	Amend outline by RD	Aaron	Chozen	2023/11/8
D03	All	Amend the patch info.	Aaron	Chozen	2024/06/11

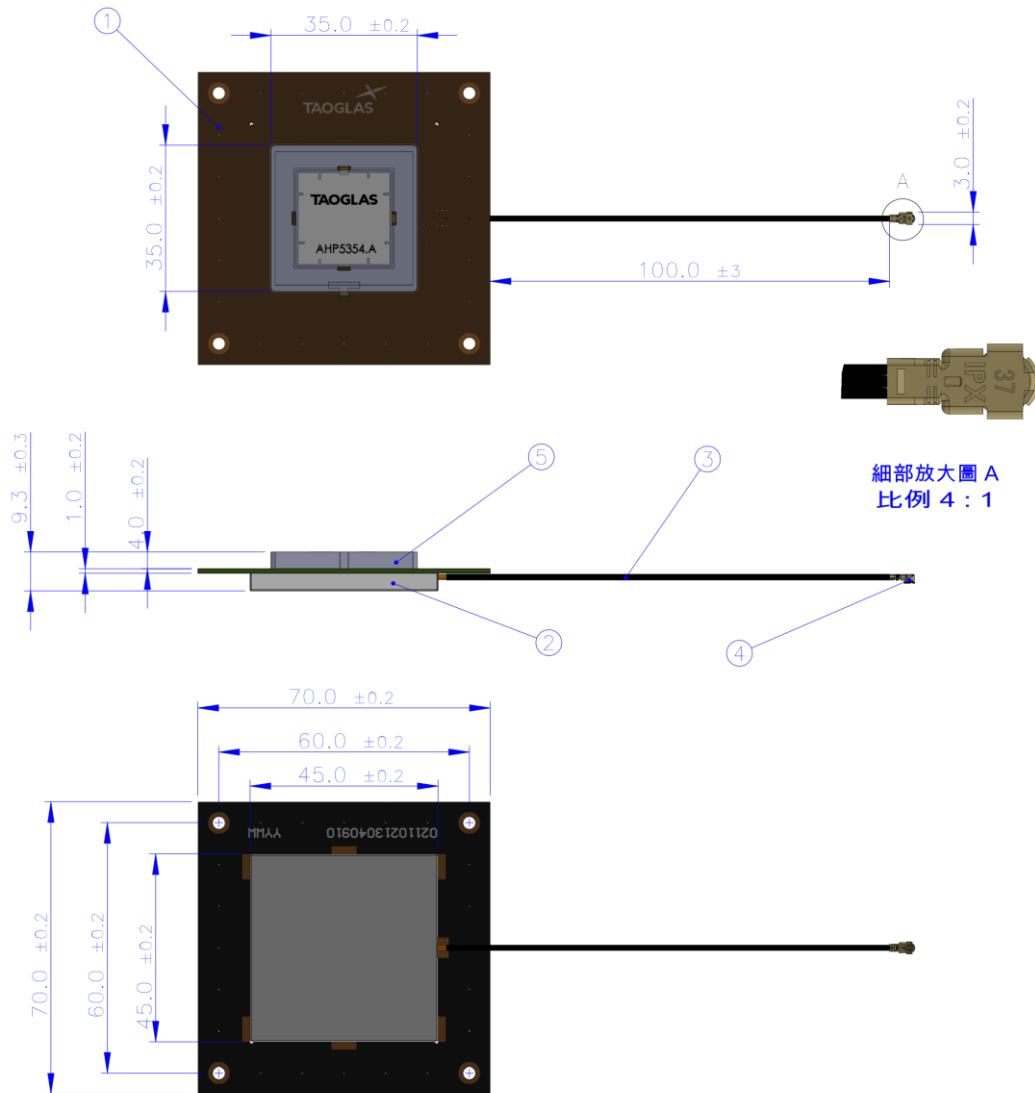

細部放大圖 A
比例 4 : 1

	Name	Material	Finish	Qty
1	PCB	NP-140	Black	1
2	Shielding Can	SECC	Ni Plated	1
3	1.37 Coaxial cable	FEP	Gray	1
4	IPEX MHFHT	Brass	Au Plated	1
5	Patch	Ceramic	White	1

APPROVED BY: Chozen	 <small>This drawing is Taoglas Confidential Information and its inherent design concepts are property of Taoglas. This is not to be copied or shared with third parties without the prior written consent of Taoglas.</small>
CHECK BY: Aaron	
DRAWN BY: Aaron	TITLE: GNSS L1/L5 Active Patch 2 Stage LNA 35*35*4mm 100mm 1.37 I-PEX MHF(U,FL)
DATE: 2023/08/17	
UNLESS OTHERWISE SPECIFIED TOLERANCES ON: XX±0.5, X±0.3, X±0.2, .XX±0.1, XXX±0.05	PART NO.: AHP5354A.07.0100C
THIRD ANGLE PROJECTION	UNIT: mm SCALE: 1:2 PAGES: 1/1 REV: D03

4. Packaging

1 PCS AHP5354A.07.0100C per PE Bag



60pcs AHP5354A.07.0100C per Carton
 Dimensions: 390 x 320 x 290 mm
 Weight: 6Kg

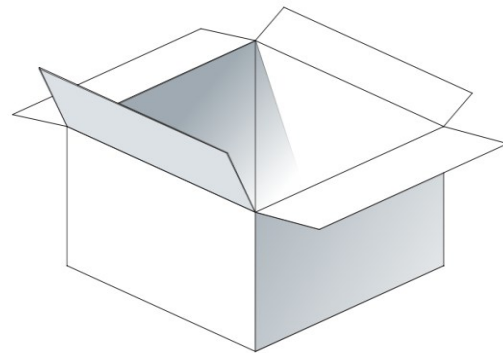

5. Antenna Characteristics

5.1 Test Setup

AUT



Vector Network Analyzer



VNA Test Set-up

5.2 Return Loss

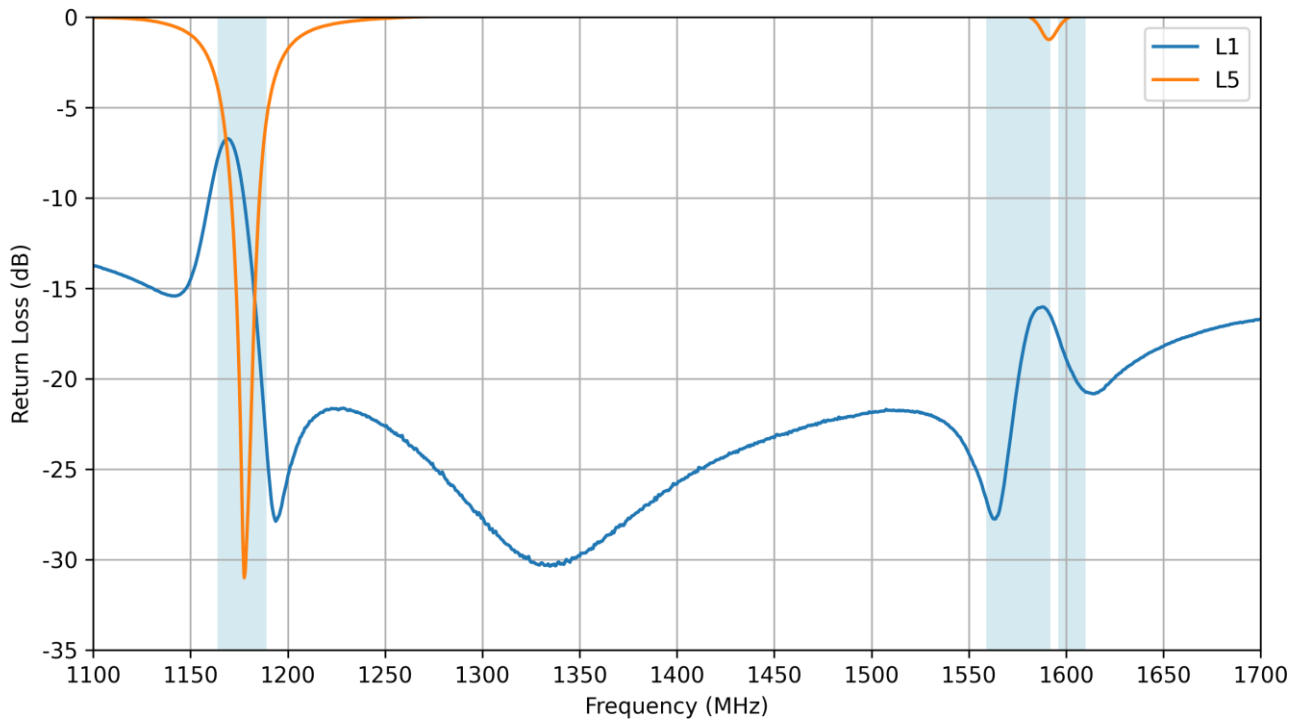

5.3 VSWR

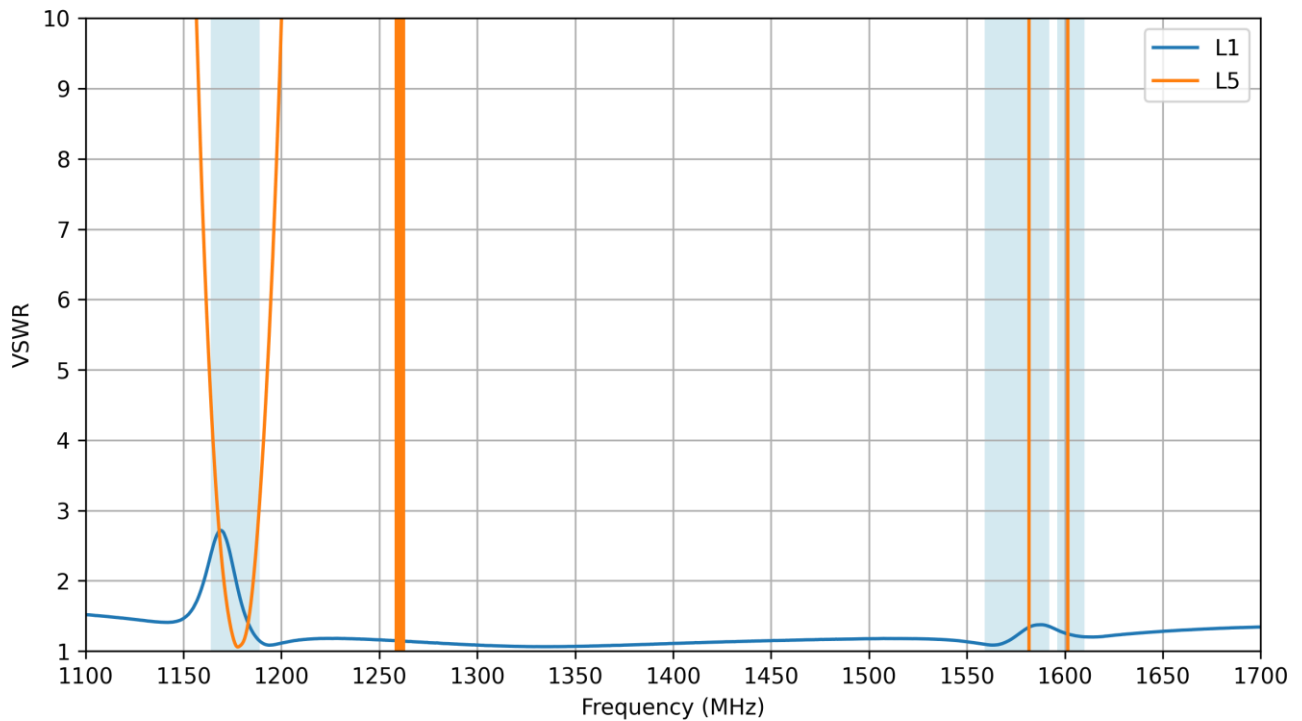

5.4 Efficiency

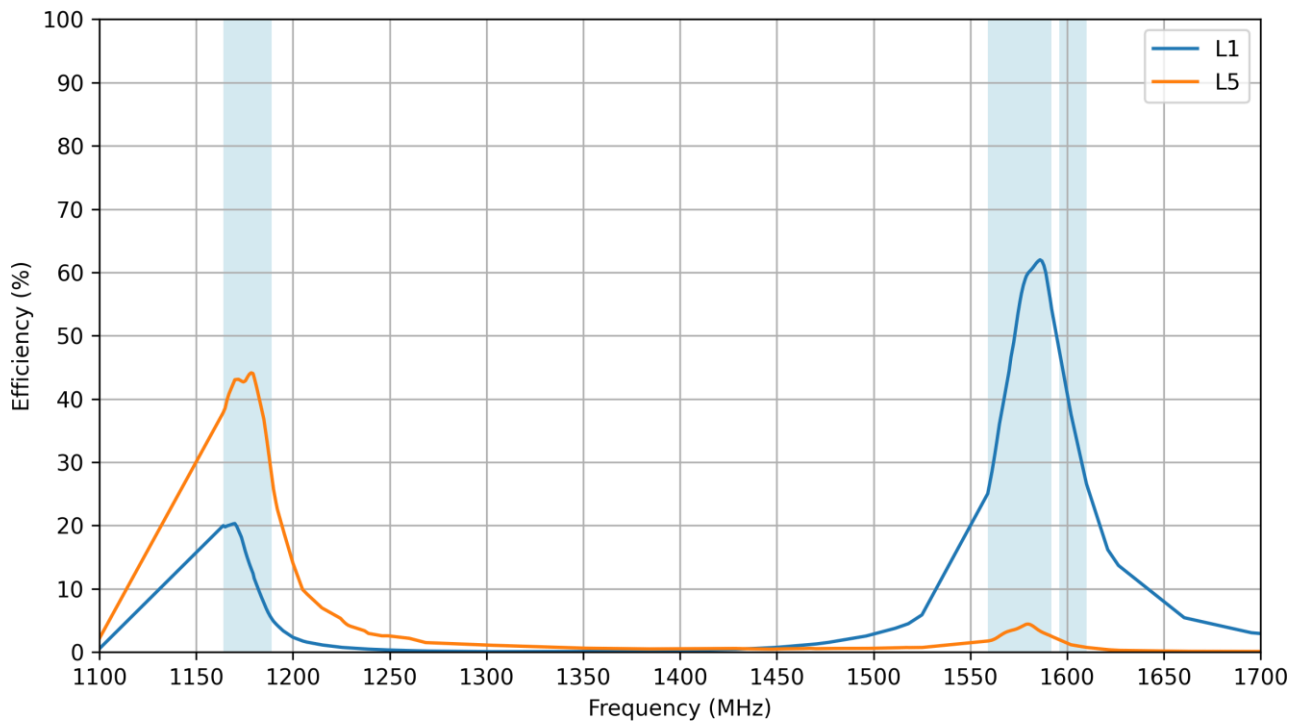

5.5 Average Gain

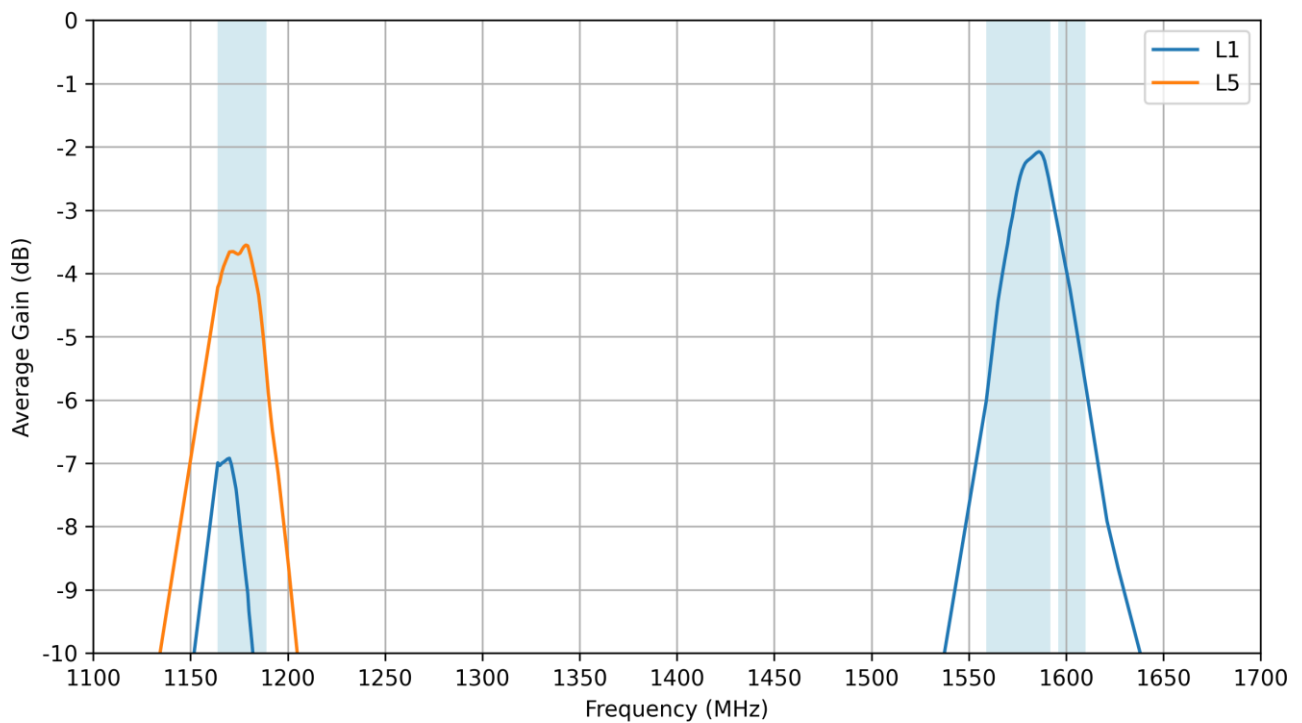

5.6 Peak Gain

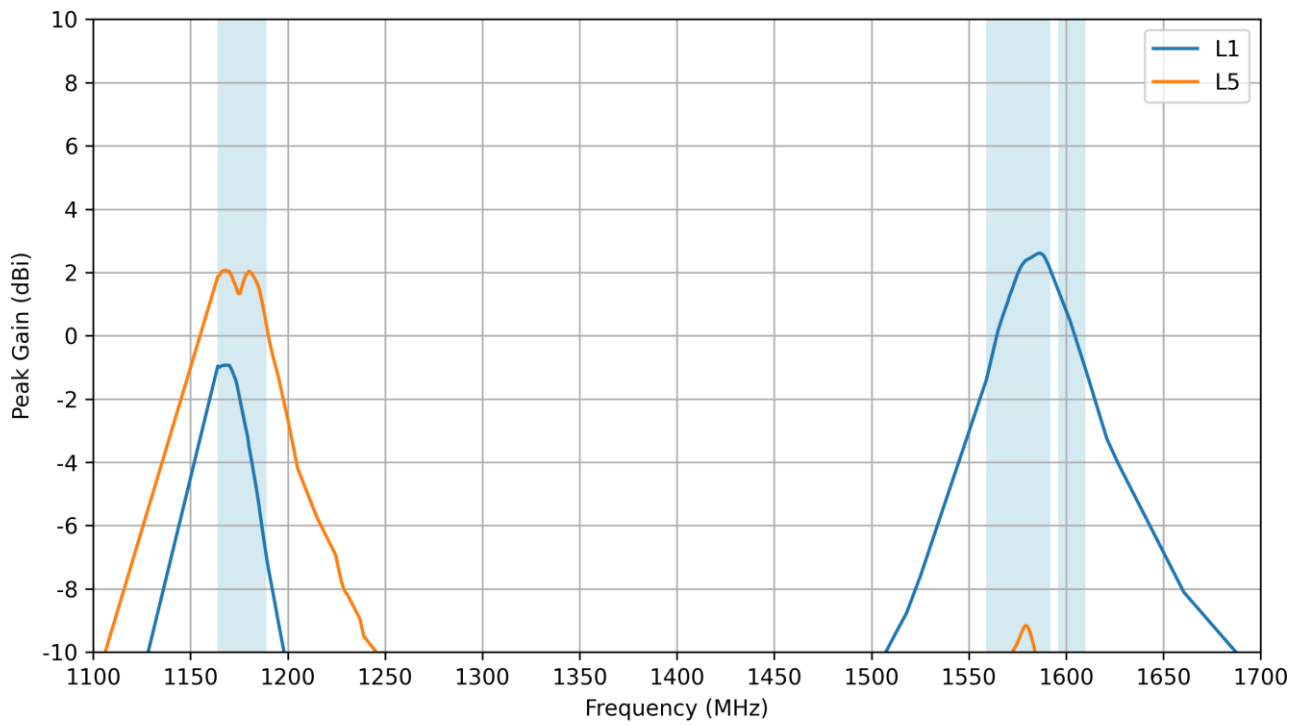

5.7 Axial Ratio

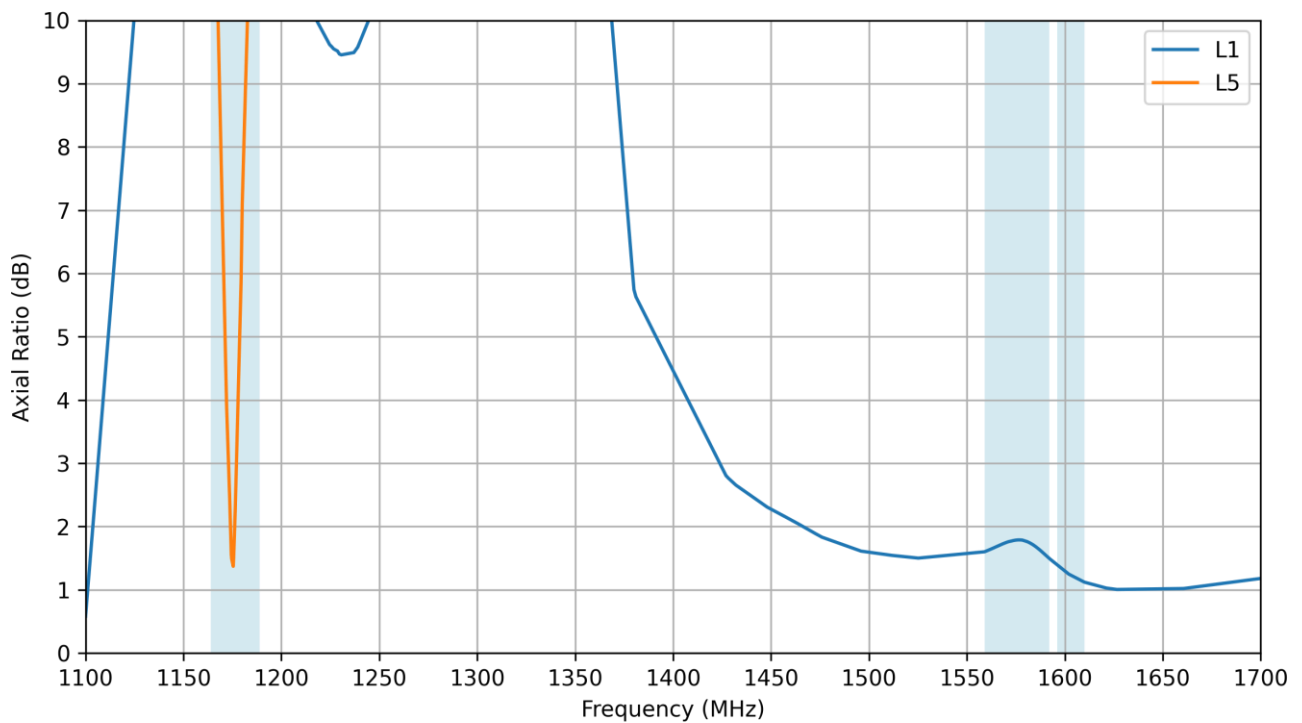

5.8 PCO

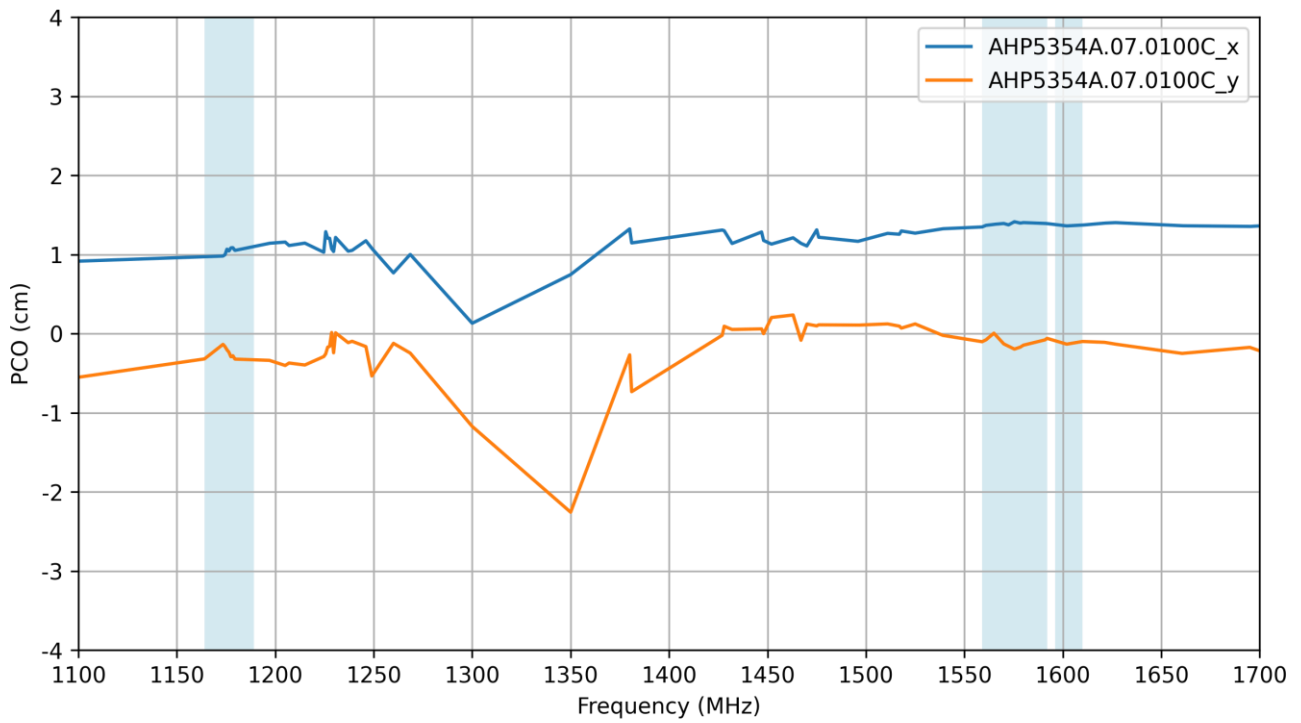

5.9 PCV

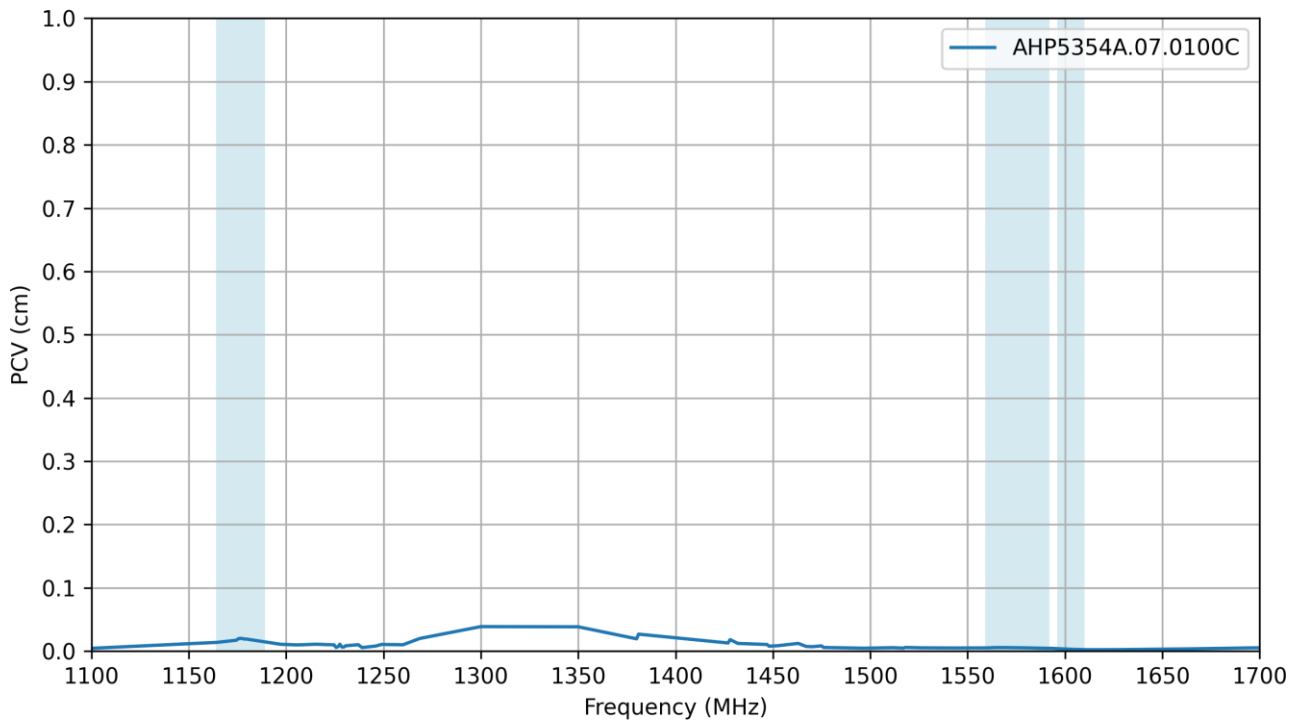

6. Radiation Patterns

6.1 Test Setup

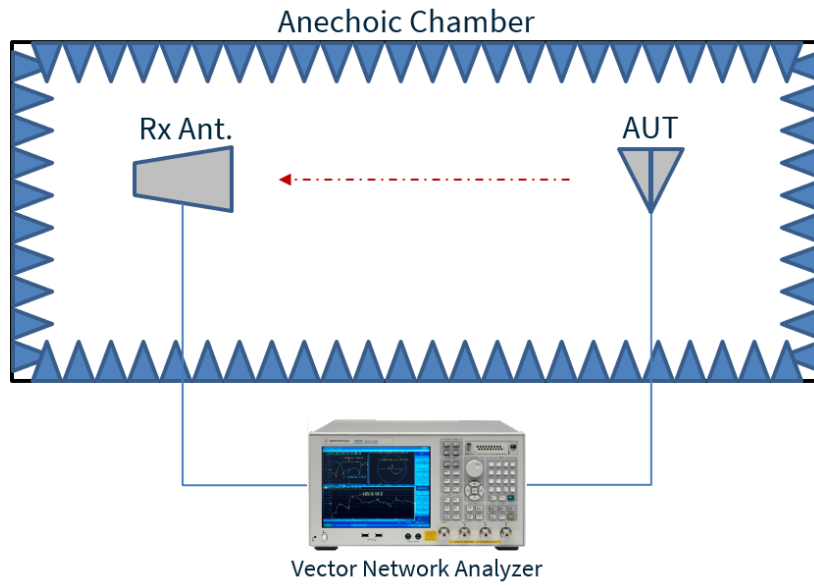

Chamber Test Set-up

6.2 L5 Patterns at 1176 MHz

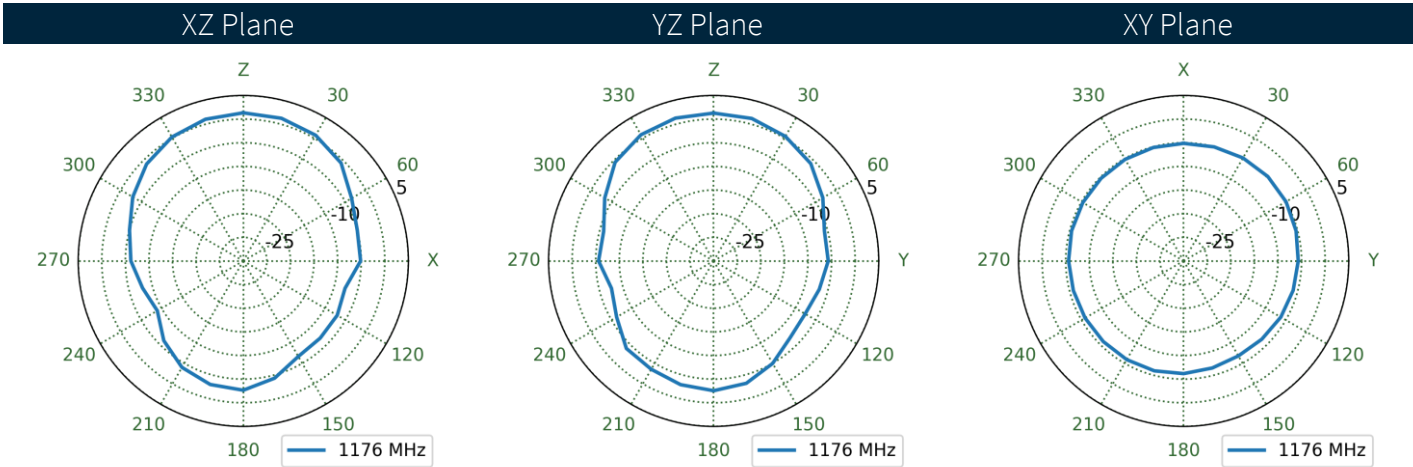
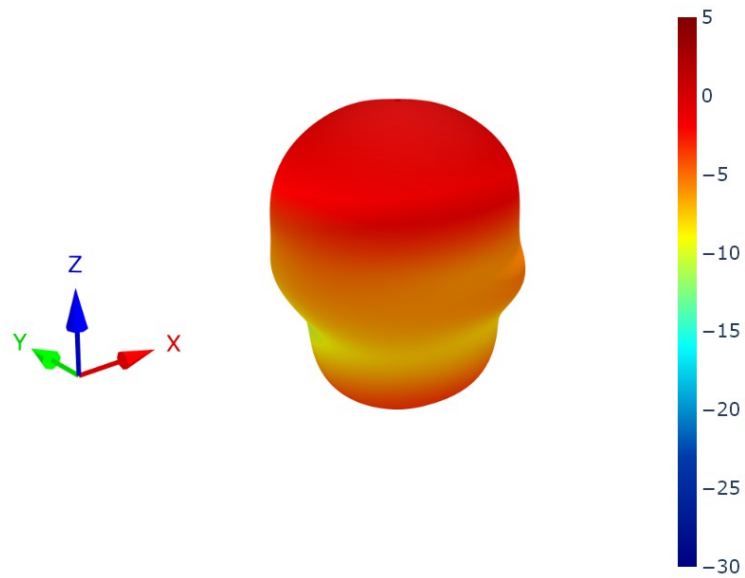

6.3 L1 Patterns at 1561 MHz

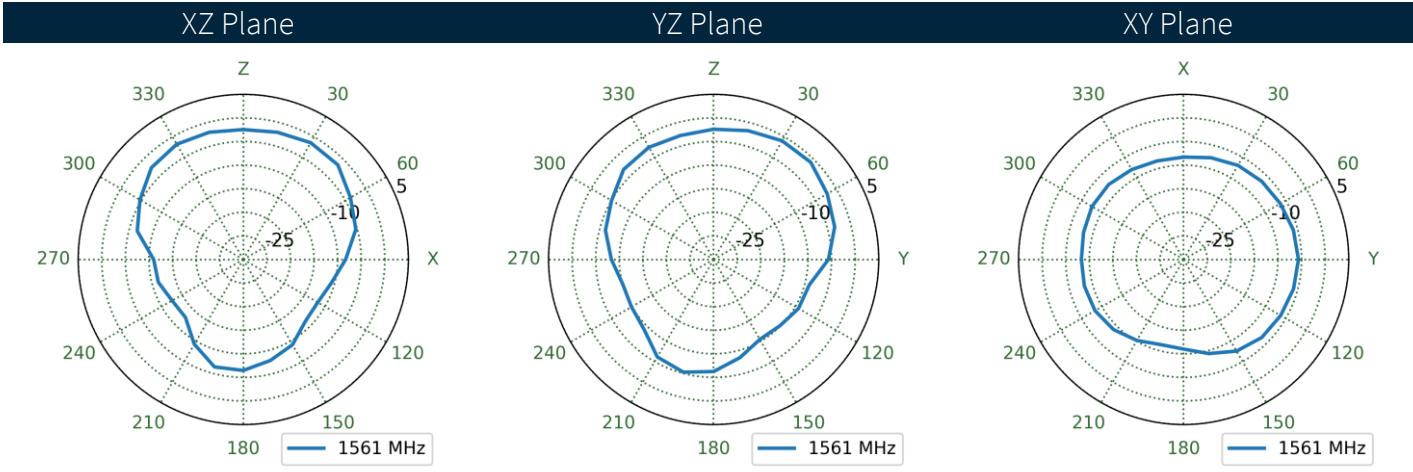
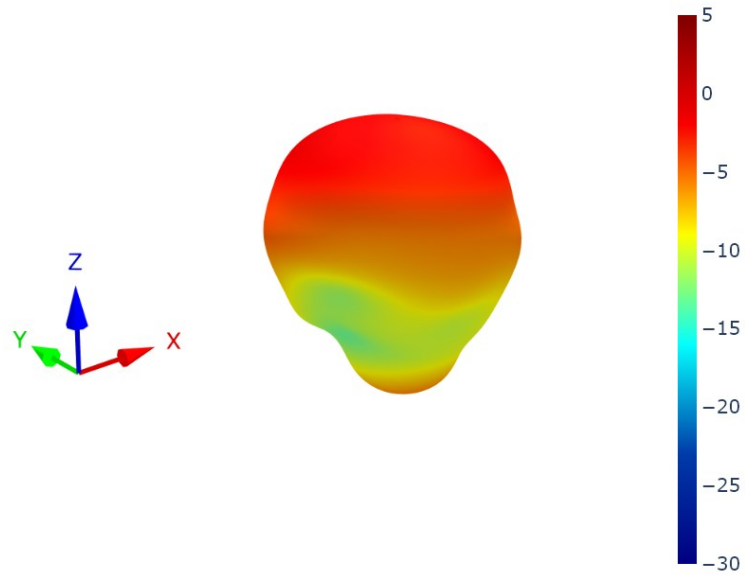

6.4 L1 Patterns at 1575 MHz

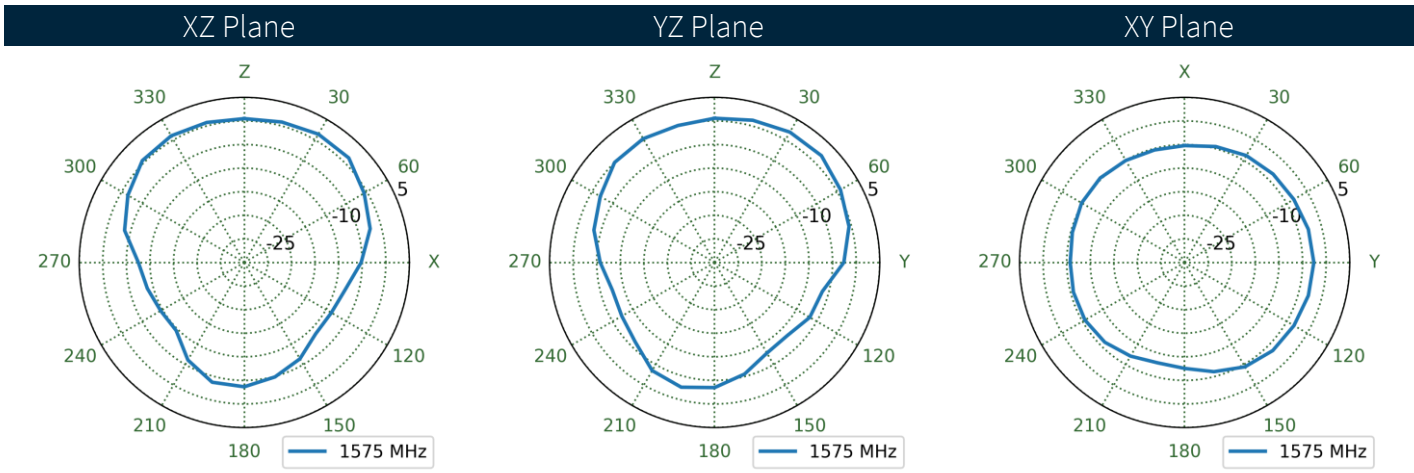
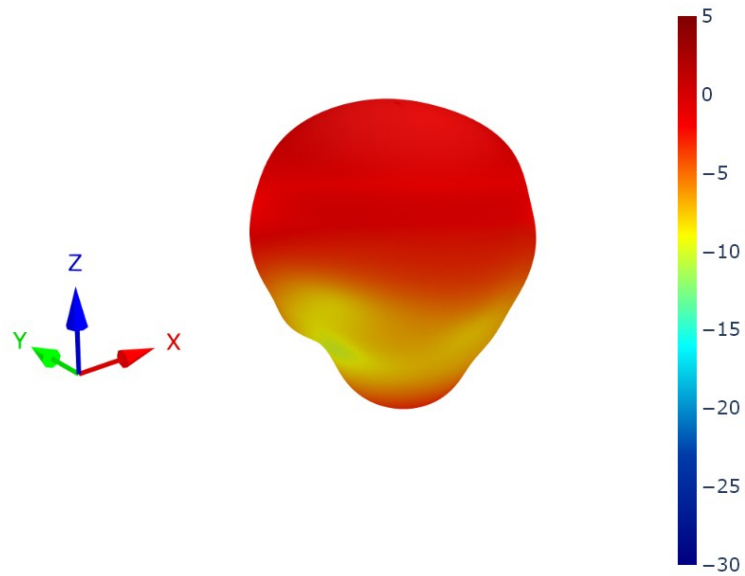

6.5 L1 Patterns at 1602 MHz

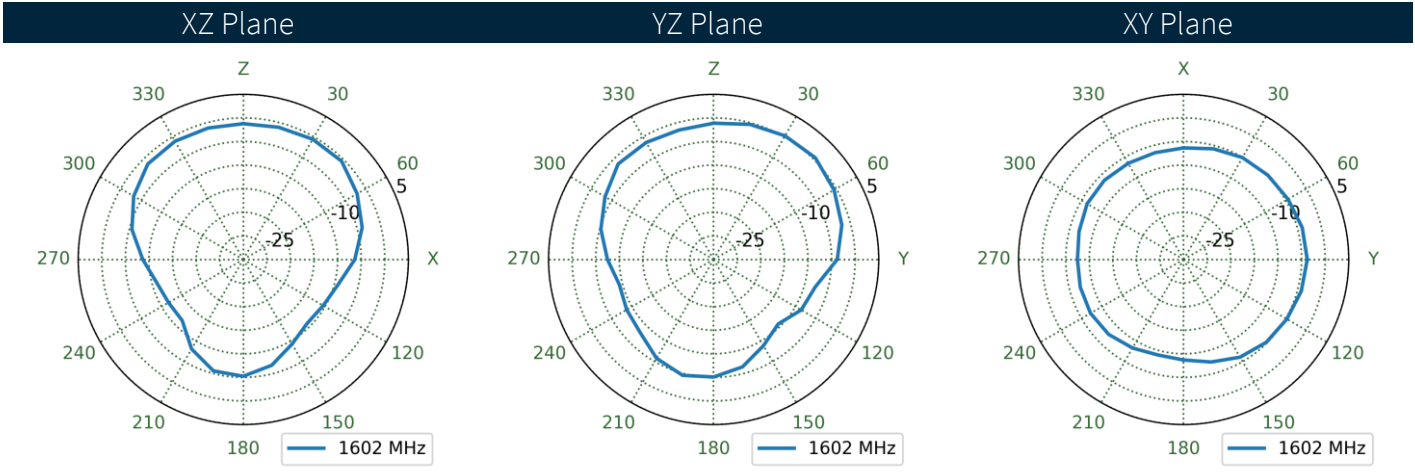
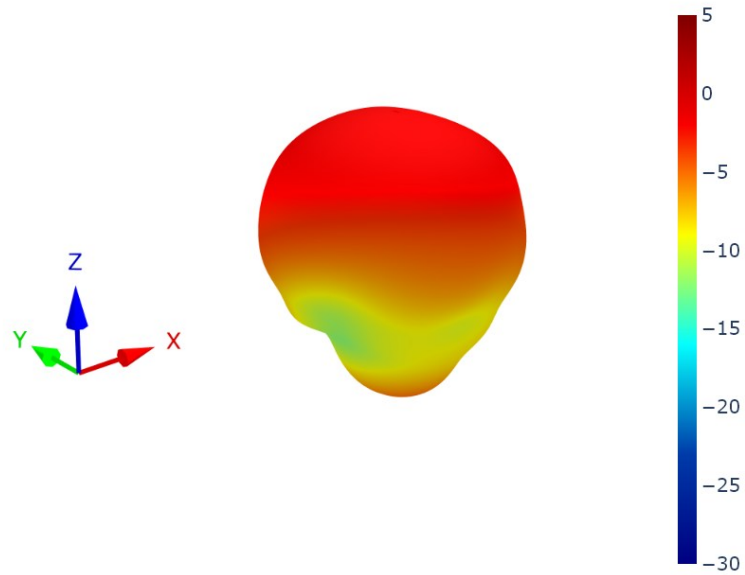

7. LNA Characteristics

7.1 Block Diagram

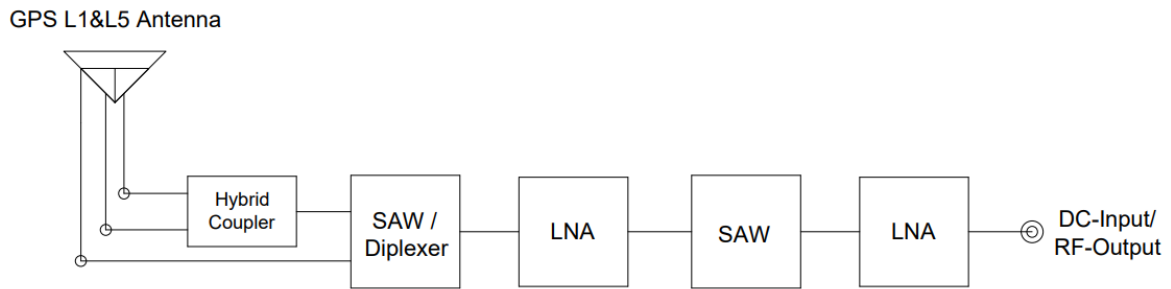

7.2 Noise Figure – Low-Band

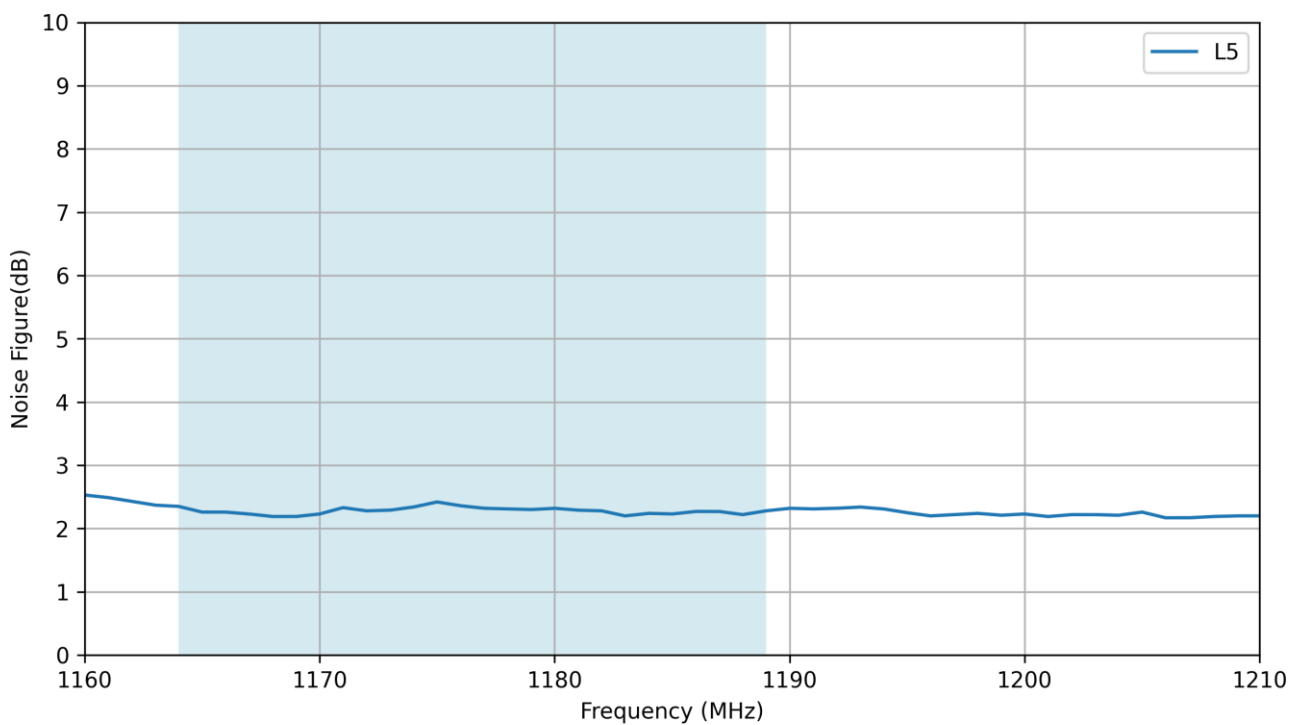

7.3 Noise Figure – High-Band

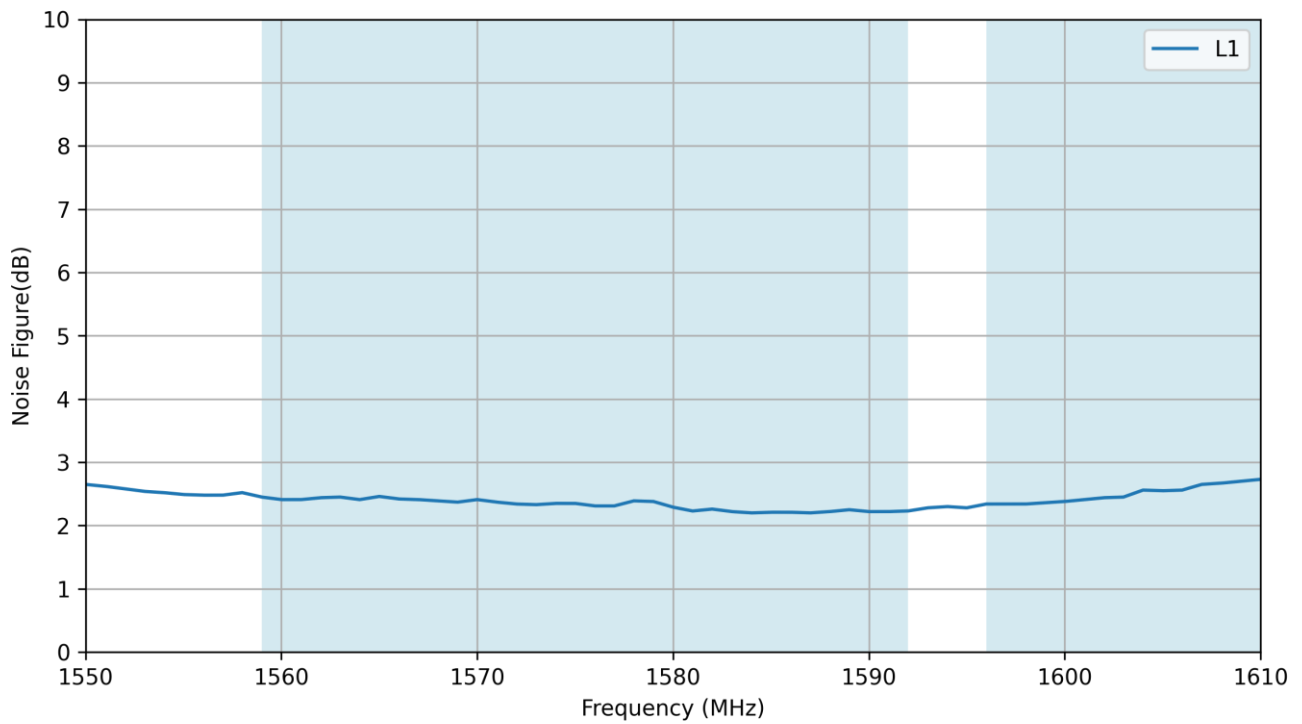

7.4 Gain – Low-Band

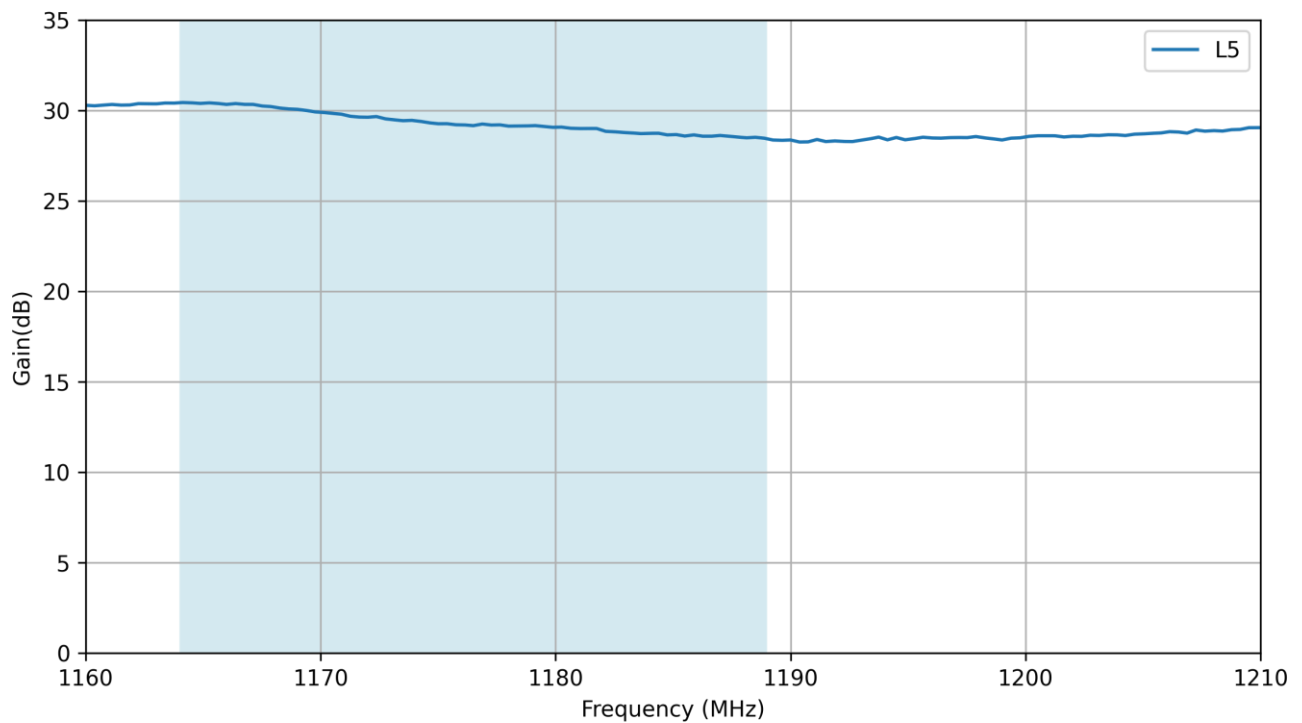

7.5 Gain – High-Band

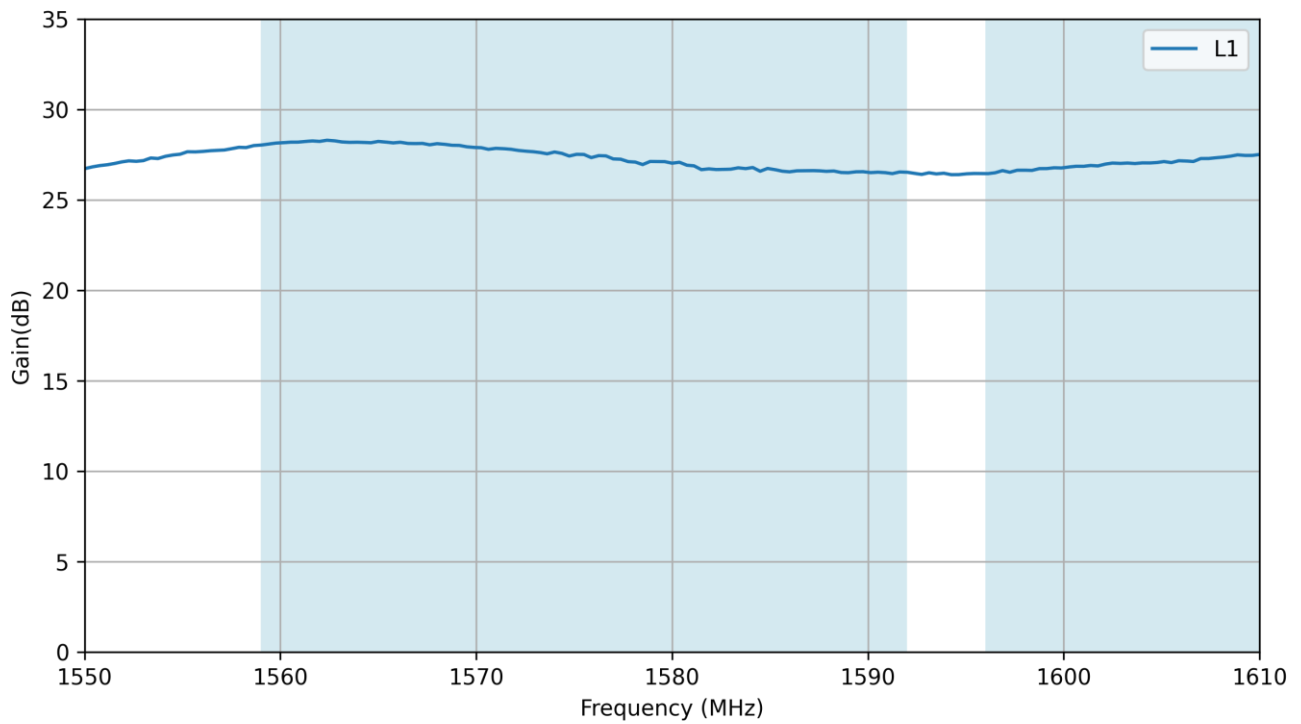

7.6 Out Of Band Rejection

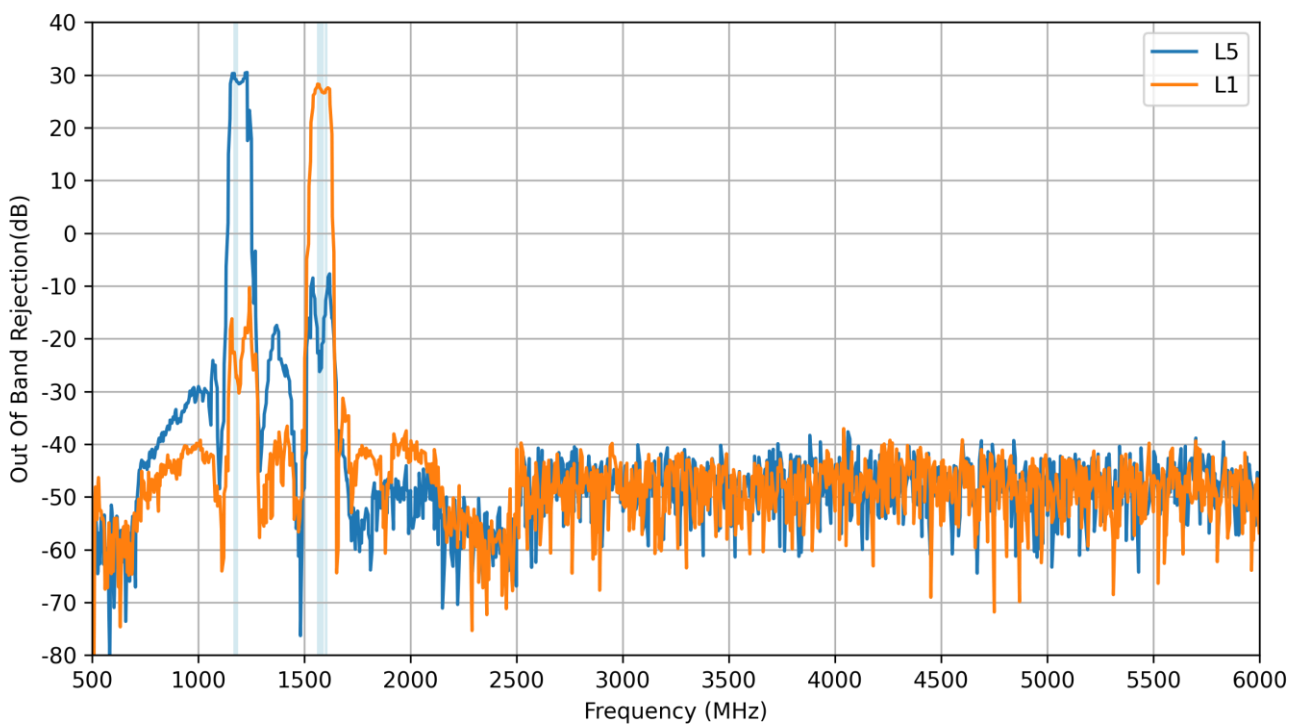

Changelog for the datasheet

SPE-24-8-252 – AHP5354A.07.0100C

Revision: A (Initial Release)

Date:	2024-10-08
Notes:	Initial Datasheet Release
Author:	Gary West

Previous Revisions



www.taoglas.com

