

General Purpose Transistors

NPN, 65 V, 100 mA

NST846MTWFT

The NST846MTWFT is designed for general purpose amplifier applications. It is housed in an ultra-compact DFN1010-3 with wettable flanks, recommended for the automotive industry's optical inspection methods. The transistor is ideal for low-power surface mount applications where board space and reliability are at a premium.

Features

- Wettable Flank Package for Optimal Automated Optical Inspection (AOI)
- NSV Prefix for Automotive and Other Applications Requiring Unique Site and Control Change Requirements; AEC-Q101 Qualified and PPAP Capable
- These Devices are Pb-Free, Halogen Free/BFR Free and are RoHS Compliant

MAXIMUM RATINGS (T_A = 25°C)

Rating	Symbol	Max	Unit
Collector - Emitter Voltage	V _{CEO}	65	Vdc
Collector - Base Voltage	V _{CBO}	80	Vdc
Emitter - Base Voltage	V _{EBO}	5.0	Vdc
Collector Current - Continuous	I _C	100	mA
Collector Current - Peak	I _{CM}	200	mA

Stresses exceeding those listed in the Maximum Ratings table may damage the device. If any of these limits are exceeded, device functionality should not be assumed, damage may occur and reliability may be affected.

THERMAL CHARACTERISTICS

Characteristic	Symbol	Max	Unit
Thermal Resistance Junction-to-Ambient (Note 1)	R _{θJA}	220	°C/W
Total Power Dissipation per Device @T _A = 25°C (Note 1)	P _D	570	mW
Junction and Storage Temperature Range	T _J , T _{stg}	-65 to +150	°C

1. Per JESD51-7 with standard PCB footprint and 2 oz. Cu.

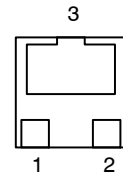
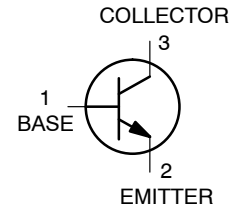

XDFNW3
CASE 521AC

46 = Specific Device Code
M = Month Code

MARKING DIAGRAM

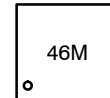

ORDERING INFORMATION

Device	Package	Shipping†
NST846MTWFTBG	XDFNW3 (Pb-Free)	3000 / Tape & Reel
NSVT846MTWFTBG	XDFNW3 (Pb-Free)	3000 / Tape & Reel

†For information on tape and reel specifications, including part orientation and tape sizes, please refer to our Tape and Reel Packaging Specifications Brochure, BRD8011/D.

NST846MTWFT

ELECTRICAL CHARACTERISTICS ($T_A = 25^\circ\text{C}$ unless otherwise noted)

Characteristic	Symbol	Min	Typ	Max	Unit
OFF CHARACTERISTICS					
Collector – Emitter Breakdown Voltage ($I_C = 10\text{ mA}$)	$V_{(BR)CEO}$	65	–	–	V
Collector – Emitter Breakdown Voltage ($I_C = 10\ \mu\text{A}$, $V_{EB} = 0$)	$V_{(BR)CES}$	80	–	–	V
Collector – Base Breakdown Voltage ($I_C = 10\ \mu\text{A}$)	$V_{(BR)CBO}$	80	–	–	V
Emitter – Base Breakdown Voltage ($I_E = 0.1\ \mu\text{A}$, $I_C = 0$)	$V_{(BR)EBO}$	6.0	–	–	V
Collector Cutoff Current ($V_{CB} = 30\text{ V}$) ($V_{CB} = 30\text{ V}$, $T_A = 150^\circ\text{C}$)	I_{CBO}	–	–	15.0 5.0	nA μA
Emitter – Base Cutoff Current ($V_{BE} = 6\text{ V}$, $I_C = 0$)	I_{EBO}	–	–	0.1	μA

ON CHARACTERISTICS

DC Current Gain ($I_C = 10\ \mu\text{A}$, $V_{CE} = 5.0\text{ V}$) ($I_C = 2.0\text{ mA}$, $V_{CE} = 5.0\text{ V}$)	(Note 2) h_{FE}	– 220	150 290	– 450	
Collector – Emitter Saturation Voltage ($I_C = 10\text{ mA}$, $I_B = 0.5\text{ mA}$) ($I_C = 100\text{ mA}$, $I_B = 5.0\text{ mA}$)	(Note 2) $V_{CE(sat)}$	– –	– –	0.25 0.60	V
Base – Emitter Saturation Voltage ($I_C = 10\text{ mA}$, $I_B = 0.5\text{ mA}$) ($I_C = 100\text{ mA}$, $I_B = 5.0\text{ mA}$)	(Note 2) $V_{BE(sat)}$	– –	0.7 0.9	– –	V
Base – Emitter Turn-on Voltage ($I_C = 2.0\text{ mA}$, $V_{CE} = 5.0\text{ V}$) ($I_C = 10\text{ mA}$, $V_{CE} = 5.0\text{ V}$)	(Note 2) $V_{BE(on)}$	0.6 –	– –	0.75 0.82	V

SMALL-SIGNAL CHARACTERISTICS

Transition Frequency ($I_C = 10\text{ mA}$, $V_{CE} = 5.0\text{ V}$, $f = 100\text{ MHz}$)	f_T	100	–	–	MHz
Output Capacitance ($V_{CB} = 10\text{ V}$, $f = 1.0\text{ MHz}$)	C_{obo}	–	1.0	3.0	pF
Noise Figure ($I_C = 0.2\text{ mA}$, $V_{CE} = 5.0\text{ Vdc}$, $R_S = 2.0\text{ k}\Omega$, $f = 1.0\text{ kHz}$, $BW = 200\text{ Hz}$)	NF	–	1.0	–	dB

Product parametric performance is indicated in the Electrical Characteristics for the listed test conditions, unless otherwise noted. Product performance may not be indicated by the Electrical Characteristics if operated under different conditions.

2. Pulse Condition: Pulse Width = 300 μs , Duty Cycle $\leq 2\%$.

TYPICAL CHARACTERISTICS

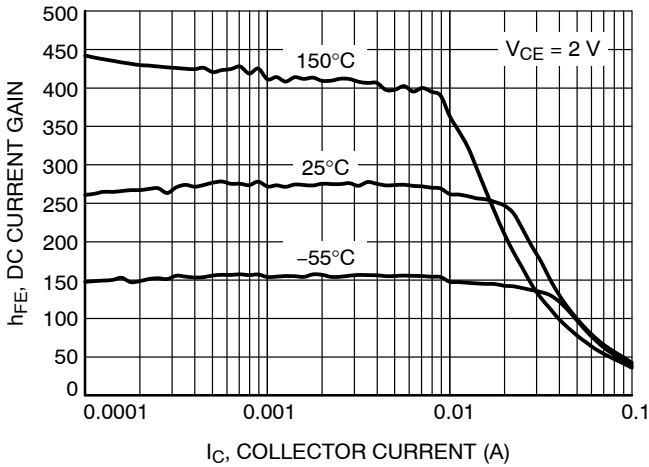

Figure 1. DC Current Gain

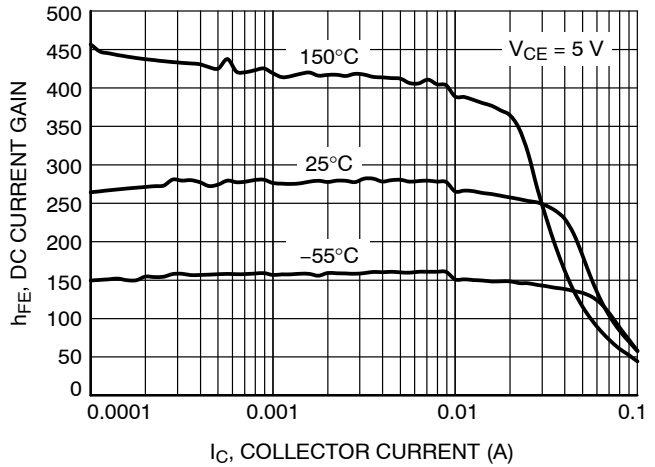

Figure 2. DC Current Gain

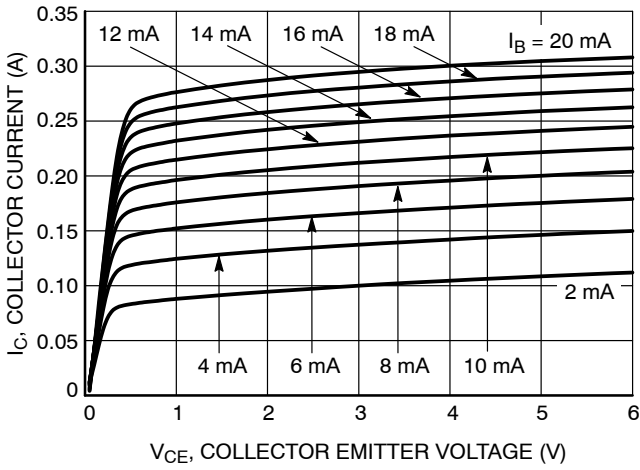

Figure 3. Collector Current as a Function of Collector Emitter Voltage

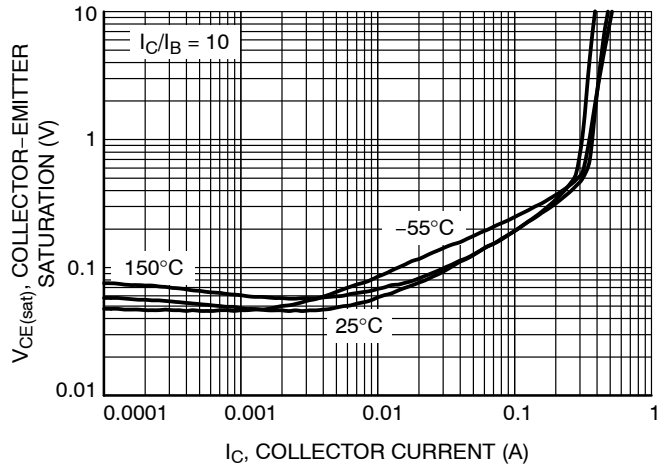

Figure 4. Collector-Emitter Saturation Voltage

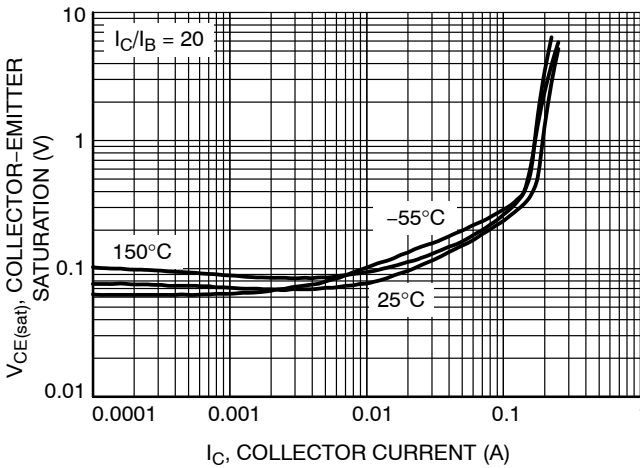

Figure 5. Collector-Emitter Saturation Voltage

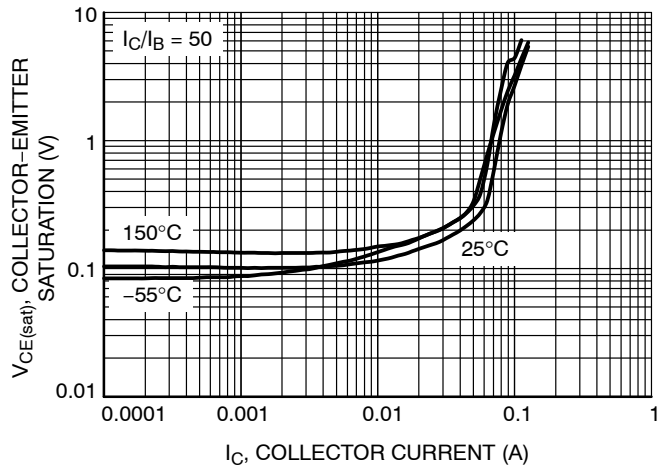

Figure 6. Collector-Emitter Saturation Voltage

NST846MTWFT

TYPICAL CHARACTERISTICS

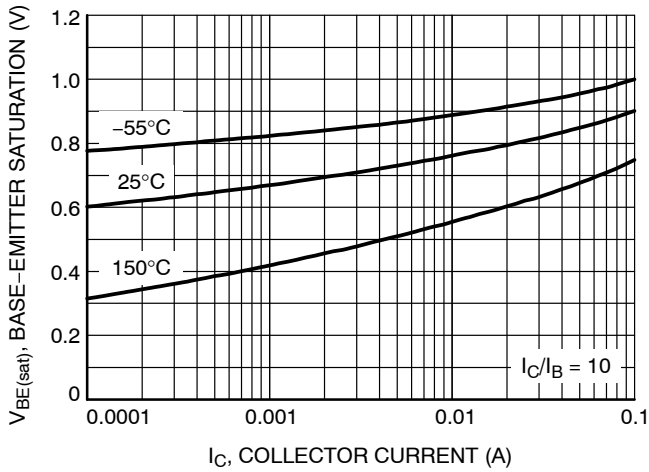

Figure 7. Base-Emitter Saturation Voltage

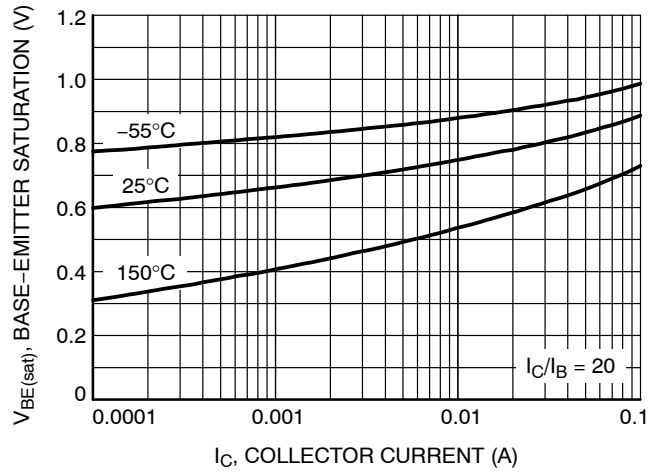

Figure 8. Base-Emitter Saturation Voltage

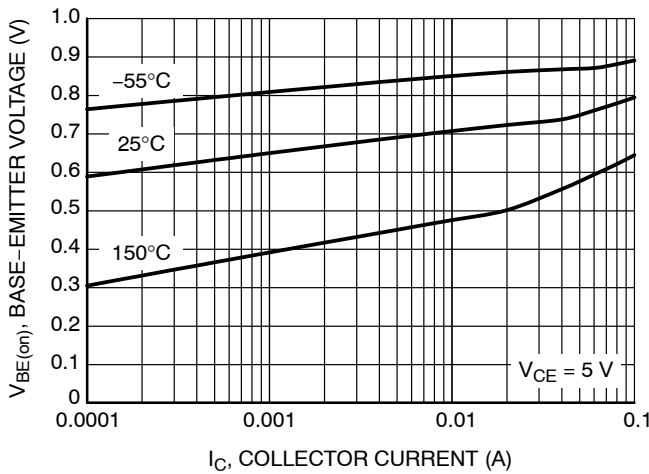

Figure 9. Base-Emitter "ON" Voltage

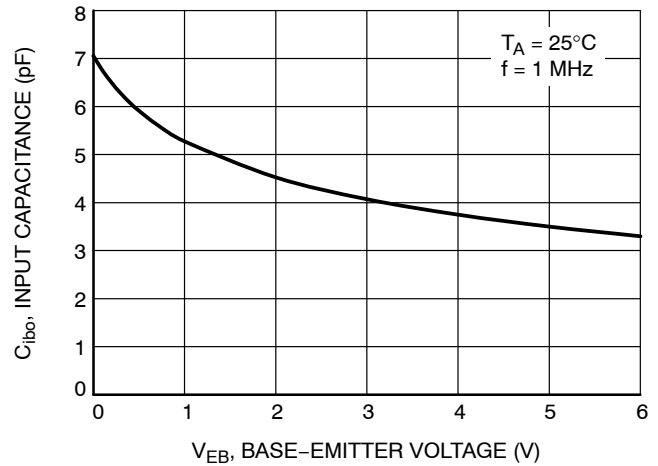

Figure 10. Input Capacitance

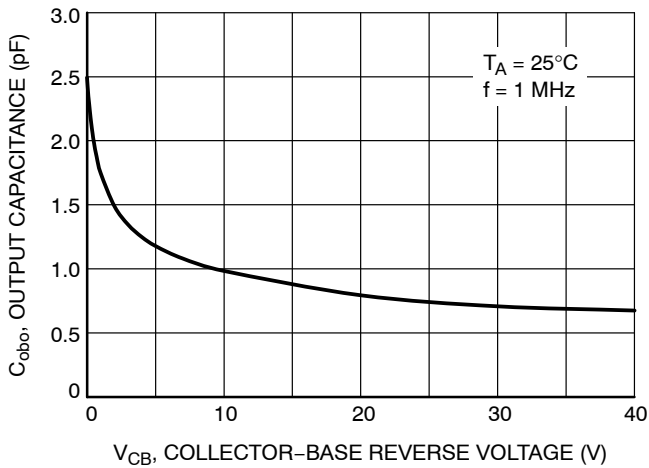

Figure 11. Output Capacitance

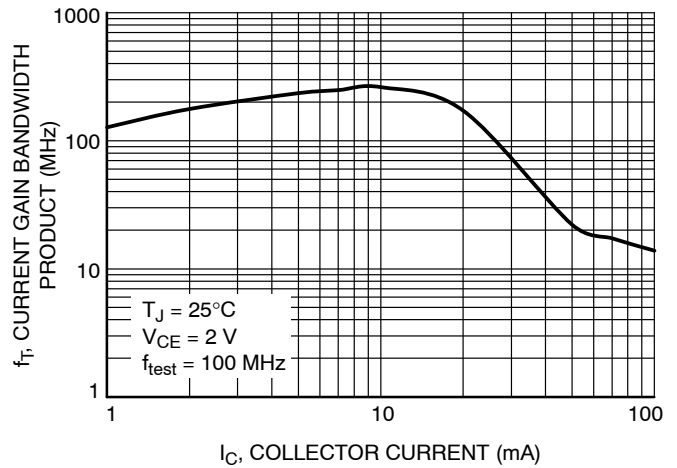

Figure 12. f_T Current Gain Bandwidth Product

NST846MTWFT

TYPICAL CHARACTERISTICS

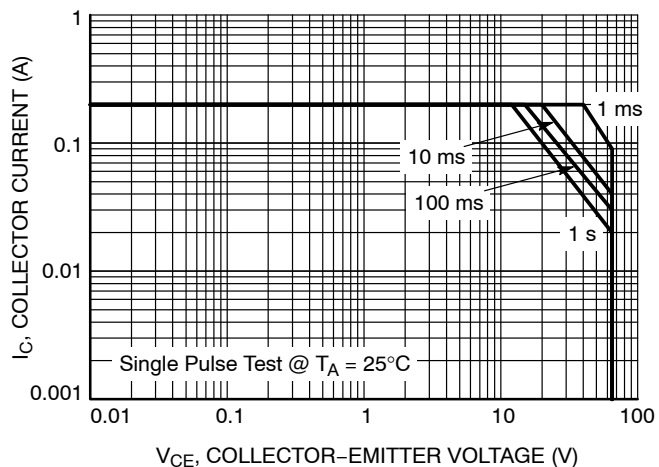

Figure 13. Safe Operating Area

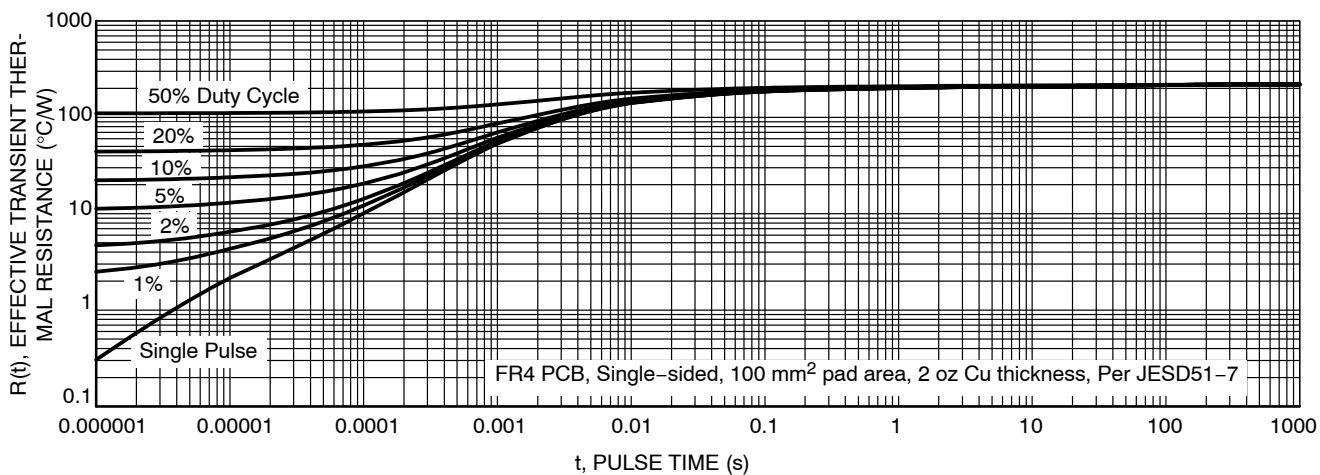
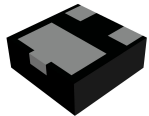
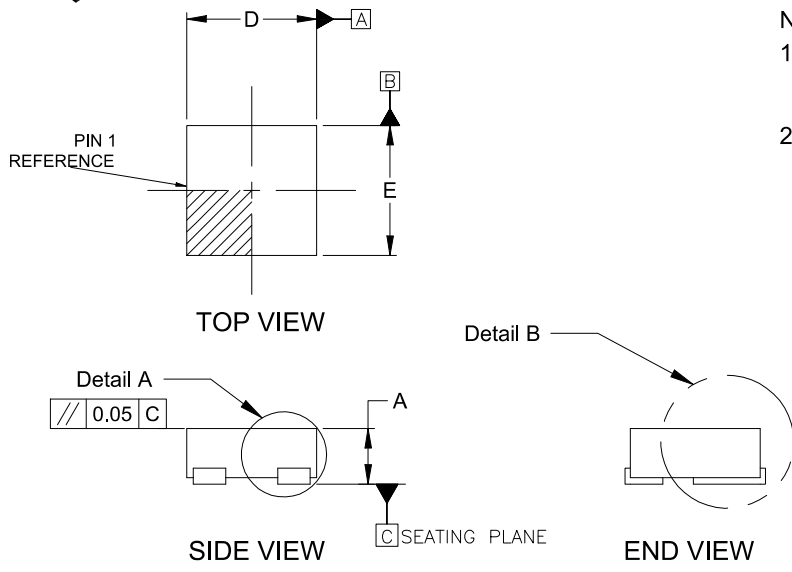

Figure 14. Thermal Resistance



XDFNW3 1.00x1.00x0.38 0.65P
CASE 521AC
ISSUE B

DATE 07 MAY 2024



NOTES:

1. DIMENSIONING AND TOLERANCING PER ASME Y14.5M, 2018.
2. CONTROLLING DIMENSION: MILLIMETERS

DIM	MILLIMETERS		
	MIN.	NOM.	MAX.
A	0.32	0.38	0.44
A1	0.00	---	0.04
A3	0.125 REF		
b	0.20	0.25	0.30
D	0.90	1.00	1.10
D1	0.00	---	0.04
D2	0.75	0.80	0.85
E	0.90	1.00	1.10
E2	0.40	0.45	0.50
e	0.65 BSC		
L	0.465	0.515	0.565
K	0.23 REF		

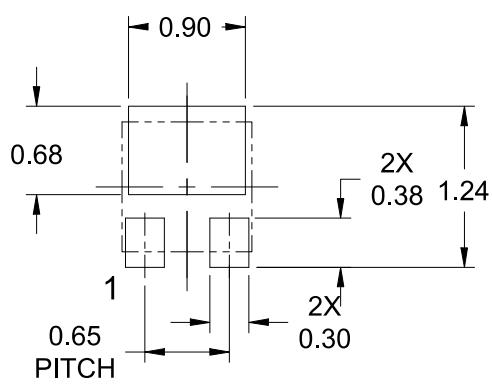
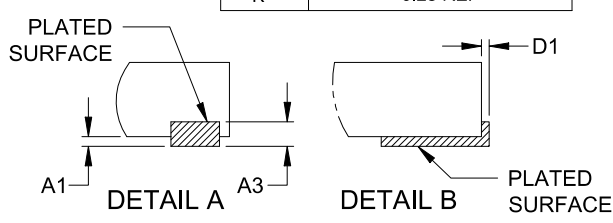
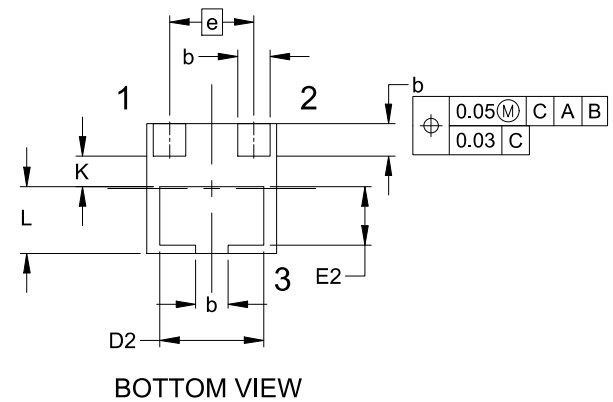

GENERIC MARKING DIAGRAM*

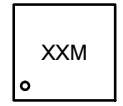

XX = Specific Device Code
M = Month Code

*This information is generic. Please refer to device data sheet for actual part marking. Pb-Free indicator, "G" or microdot "•", may or may not be present. Some products may not follow the Generic Marking.

RECOMMENDED MOUNTING FOOTPRINT*
* For additional information on our Pb-Free strategy and soldering details, please download the ONSEMI Soldering and Mounting Techniques Reference Manual, S•LDERRM/D.

DOCUMENT NUMBER:	98AON11341H	Electronic versions are uncontrolled except when accessed directly from the Document Repository. Printed versions are uncontrolled except when stamped "CONTROLLED COPY" in red.
DESCRIPTION:	XDFNW3 1.00x1.00x0.38 0.65P	PAGE 1 OF 1

onsemi and ONSEMI are trademarks of Semiconductor Components Industries, LLC dba onsemi or its subsidiaries in the United States and/or other countries. onsemi reserves the right to make changes without further notice to any products herein. onsemi makes no warranty, representation or guarantee regarding the suitability of its products for any particular purpose, nor does onsemi assume any liability arising out of the application or use of any product or circuit, and specifically disclaims any and all liability, including without limitation special, consequential or incidental damages. onsemi does not convey any license under its patent rights nor the rights of others.

onsemi, **Onsemi**, and other names, marks, and brands are registered and/or common law trademarks of Semiconductor Components Industries, LLC dba "**onsemi**" or its affiliates and/or subsidiaries in the United States and/or other countries. **onsemi** owns the rights to a number of patents, trademarks, copyrights, trade secrets, and other intellectual property. A listing of **onsemi**'s product/patent coverage may be accessed at www.onsemi.com/site/pdf/Patent-Marking.pdf. **onsemi** reserves the right to make changes at any time to any products or information herein, without notice. The information herein is provided "as-is" and **onsemi** makes no warranty, representation or guarantee regarding the accuracy of the information, product features, availability, functionality, or suitability of its products for any particular purpose, nor does **onsemi** assume any liability arising out of the application or use of any product or circuit, and specifically disclaims any and all liability, including without limitation special, consequential or incidental damages. Buyer is responsible for its products and applications using **onsemi** products, including compliance with all laws, regulations and safety requirements or standards, regardless of any support or applications information provided by **onsemi**. "Typical" parameters which may be provided in **onsemi** data sheets and/or specifications can and do vary in different applications and actual performance may vary over time. All operating parameters, including "Typicals" must be validated for each customer application by customer's technical experts. **onsemi** does not convey any license under any of its intellectual property rights nor the rights of others. **onsemi** products are not designed, intended, or authorized for use as a critical component in life support systems or any FDA Class 3 medical devices or medical devices with a same or similar classification in a foreign jurisdiction or any devices intended for implantation in the human body. Should Buyer purchase or use **onsemi** products for any such unintended or unauthorized application, Buyer shall indemnify and hold **onsemi** and its officers, employees, subsidiaries, affiliates, and distributors harmless against all claims, costs, damages, and expenses, and reasonable attorney fees arising out of, directly or indirectly, any claim of personal injury or death associated with such unintended or unauthorized use, even if such claim alleges that **onsemi** was negligent regarding the design or manufacture of the part. **onsemi** is an Equal Opportunity/Affirmative Action Employer. This literature is subject to all applicable copyright laws and is not for resale in any manner.

ADDITIONAL INFORMATION

TECHNICAL PUBLICATIONS:

Technical Library: www.onsemi.com/design/resources/technical-documentation
onsemi Website: www.onsemi.com

ONLINE SUPPORT: www.onsemi.com/support

For additional information, please contact your local Sales Representative at www.onsemi.com/support/sales

