

Silicon Carbide (SiC) MOSFET - EliteSiC, 23 mohm, 650 V, M3S, D2PAK-7L

NVBG023N065M3S

Features

- Typical $R_{DS(ON)} = 23\text{ m}\Omega @ V_{GS} = 18\text{ V}$
- Ultra Low Gate Charge ($Q_{G(tot)} = 69\text{ nC}$)
- High Speed Switching with Low Capacitance ($C_{oss} = 153\text{ pF}$)
- 100% Avalanche Tested
- AEC-Q101 Qualified and PPAP Capable
- This Device is Halide Free and RoHS Compliant with Exemption 7a, Pb-Free 2LI (on Second Level Interconnection)

Applications

- Automotive On Board Charger
- Automotive DC-DC Converter for EV/HEV

MAXIMUM RATINGS ($T_J = 25^\circ\text{C}$ unless otherwise noted)

Parameter	Symbol	Value	Unit
Drain-to-Source Voltage	V_{DSS}	650	V
Gate-to-Source Voltage	V_{GS}	-8/+22	
Continuous Drain Current	$T_C = 25^\circ\text{C}$	I_D	70
Power Dissipation		P_D	263
Continuous Drain Current	$T_C = 100^\circ\text{C}$	I_D	50
Power Dissipation		P_D	131
Pulsed Drain Current (Note 1)	$T_C = 25^\circ\text{C}$, $t_p = 100\text{ }\mu\text{s}$	I_{DM}	216
Continuous Source-Drain Current (Body Diode)	$T_C = 25^\circ\text{C}$, $V_{GS} = -3\text{ V}$	I_S	38
	$T_C = 100^\circ\text{C}$, $V_{GS} = -3\text{ V}$		23
Pulsed Source-Drain Current (Body Diode) (Note 1)	$T_C = 25^\circ\text{C}$, $V_{GS} = -3\text{ V}$, $t_p = 100\text{ }\mu\text{s}$	I_{SM}	175
Single Pulse Avalanche Energy (Note 2)	$I_{LPK} = 19.6\text{ A}$, $L = 1\text{ mH}$	E_{AS}	192
Operating Junction and Storage Temperature	T_J, T_{stg}	-55 to 175	$^\circ\text{C}$
Lead Temperature for Soldering Purposes (1/8" from Case for 10 s)	T_L	270	

Stresses exceeding those listed in the Maximum Ratings table may damage the device. If any of these limits are exceeded, device functionality should not be assumed, damage may occur and reliability may be affected.

1. Single pulse, limited by max junction temperature.
2. E_{AS} of 192 mJ is based on starting $T_J = 25^\circ\text{C}$, $L = 1\text{ mH}$, $I_{AS} = 19.6\text{ A}$, $V_{DD} = 100\text{ V}$, $V_{GS} = 18\text{ V}$.

$V_{(BR)DSS}$	$R_{DS(ON)}$ TYP	I_D MAX
650 V	23 m Ω @ 18 V	70 A

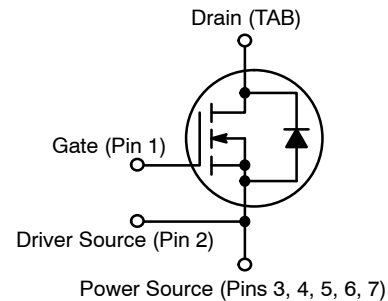

N-CHANNEL MOSFET

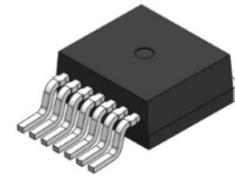

D2PAK-7L
CASE 418BJ

MARKING DIAGRAM

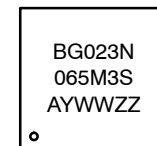

BG023N065M3S = Specific Device Code
A = Assembly Location
Y = Year
WW = Work Week
ZZ = Lot Traceability

ORDERING INFORMATION

Device	Package	Shipping [†]
NVBG023N065M3S	D2PAK-7L	800 / Tape & Reel

[†]For information on tape and reel specifications, including part orientation and tape sizes, please refer to our Tape and Reel Packaging Specification Brochure, BRD8011/D.

NVBG023N065M3S

THERMAL CHARACTERISTICS

Parameter	Symbol	Value	Unit
Thermal Resistance, Junction-to-Case (Note 3)	$R_{\theta JC}$	0.57	°C/W
Thermal Resistance, Junction-to-Ambient (Note 3)	$R_{\theta JA}$	40	

3. The entire application environment impacts the thermal resistance values shown, they are not constants and are only valid for the particular conditions noted.

RECOMMENDED OPERATING CONDITIONS

Parameter	Symbol	Value	Unit
Operation Values of Gate-to-Source Voltage	V_{GSop}	-5...-3 +18	V

Functional operation above the stresses listed in the Recommended Operating Ranges is not implied. Extended exposure to stresses beyond the Recommended Operating Ranges limits may affect device reliability.

ELECTRICAL CHARACTERISTICS ($T_J = 25^\circ\text{C}$ unless otherwise specified)

Parameter	Symbol	Test Conditions	Min	Typ	Max	Unit
-----------	--------	-----------------	-----	-----	-----	------

OFF CHARACTERISTICS

Drain-to-Source Breakdown Voltage	$V_{(BR)DSS}$	$V_{GS} = 0\text{ V}, I_D = 1\text{ mA}, T_J = 25^\circ\text{C}$	650	-	-	V
Drain-to-Source Breakdown Voltage Temperature Coefficient	$\Delta V_{(BR)DSS} / \Delta T_J$	$I_D = 1\text{ mA}$, Referenced to 25°C	-	89	-	mV/°C
Zero Gate Voltage Drain Current	I_{DSS}	$V_{DS} = 650\text{ V}, T_J = 25^\circ\text{C}$	-	-	10	μA
		$V_{DS} = 650\text{ V}, T_J = 175^\circ\text{C}$ (Note 5)	-	-	500	μA
Gate-to-Source Leakage Current	I_{GSS}	$V_{GS} = -8/+22\text{ V}, V_{DS} = 0\text{ V}$	-	-	± 1.0	μA

ON CHARACTERISTICS

Drain-to-Source On Resistance	$R_{DS(ON)}$	$V_{GS} = 18\text{ V}, I_D = 20\text{ A}, T_J = 25^\circ\text{C}$	-	23	33	m Ω
		$V_{GS} = 18\text{ V}, I_D = 20\text{ A}, T_J = 175^\circ\text{C}$ (Note 5)	-	34	-	
		$V_{GS} = 15\text{ V}, I_D = 20\text{ A}, T_J = 25^\circ\text{C}$	-	28	-	
		$V_{GS} = 15\text{ V}, I_D = 20\text{ A}, T_J = 175^\circ\text{C}$ (Note 5)	-	36	-	
Gate Threshold Voltage	$V_{GS(TH)}$	$V_{GS} = V_{DS}, I_D = 10\text{ mA}, T_J = 25^\circ\text{C}$	2.0	2.8	4.0	V
Forward Trans-conductance	g_{FS}	$V_{DS} = 10\text{ V}, I_D = 20\text{ A}$ (Note 5)	-	14	-	S

CHARGES, CAPACITANCES & GATE RESISTANCE

Input Capacitance	C_{ISS}	$V_{DS} = 400\text{ V}, V_{GS} = 0\text{ V}, f = 1\text{ MHz}$ (Note 5)	-	1951	-	pF
Output Capacitance	C_{OSS}		-	152	-	
Reverse Transfer Capacitance	C_{RSS}		-	13	-	
Total Gate Charge	$Q_{G(TOT)}$	$V_{DD} = 400\text{ V}, I_D = 20\text{ A}, V_{GS} = -3/18\text{ V}$ (Note 5)	-	69	-	nC
Gate-to-Source Charge	Q_{GS}		-	19	-	
Gate-to-Drain Charge	Q_{GD}		-	18	-	
Gate Resistance	R_G	$f = 1\text{ MHz}$	-	4.0	-	Ω

SWITCHING CHARACTERISTICS

Turn-On Delay Time	$t_{d(ON)}$	$V_{GS} = -3/18\text{ V}, I_D = 20\text{ A}, V_{DD} = 400\text{ V},$ $R_G = 4.7\text{ }\Omega, T_J = 25^\circ\text{C}$ (Note 4, 5)	-	11	-	ns
Turn-Off Delay Time	$t_{d(OFF)}$		-	35	-	
Rise Time	t_r		-	15	-	
Fall Time	t_f		-	9.6	-	
Turn-On Switching Loss	E_{ON}		-	51	-	μJ
Turn-Off Switching Loss	E_{OFF}		-	29	-	
Total Switching Loss	E_{TOT}		-	80	-	

NVBG023N065M3S

ELECTRICAL CHARACTERISTICS ($T_J = 25^\circ\text{C}$ unless otherwise specified) (continued)

Parameter	Symbol	Test Conditions	Min	Typ	Max	Unit
SWITCHING CHARACTERISTICS						
Turn-On Delay Time	$t_{d(ON)}$	$V_{GS} = -3/18\text{ V}$, $I_D = 20\text{ A}$, $V_{DD} = 400\text{ V}$, $R_G = 4.7\ \Omega$, $T_J = 175^\circ\text{C}$ (Note 4, 5)	-	9.6	-	ns
Turn-Off Delay Time	$t_{d(OFF)}$		-	41	-	
Rise Time	t_r		-	14	-	
Fall Time	t_f		-	12	-	
Turn-On Switching Loss	E_{ON}		-	51	-	μJ
Turn-Off Switching Loss	E_{OFF}		-	45	-	
Total Switching Loss	E_{TOT}		-	96	-	

SOURCE-TO-DRAIN DIODE CHARACTERISTICS

Forward Diode Voltage	V_{SD}	$I_{SD} = 20\text{ A}$, $V_{GS} = -3\text{ V}$, $T_J = 25^\circ\text{C}$	-	4.5	6.0	V
		$I_{SD} = 20\text{ A}$, $V_{GS} = -3\text{ V}$, $T_J = 175^\circ\text{C}$ (Note 5)	-	4.2	-	
Reverse Recovery Time	t_{RR}	$V_{GS} = -3\text{ V}$, $I_S = 20\text{ A}$, $di/dt = 1000\text{ A}/\mu\text{s}$, $V_{DS} = 400\text{ V}$, $T_J = 25^\circ\text{C}$ (Note 5)	-	19	-	ns
Charge time	t_a		-	11	-	
Discharge time	t_b		-	8	-	
Reverse Recovery Charge	Q_{RR}		-	97	-	nC
Reverse Recovery Energy	E_{REC}		-	8.7	-	μJ
Peak Reverse Recovery Current	I_{RRM}		-	11	-	A

Product parametric performance is indicated in the Electrical Characteristics for the listed test conditions, unless otherwise noted. Product performance may not be indicated by the Electrical Characteristics if operated under different conditions.

4. EON/EOFF result is with body diode.

5. Defined by design, not subject to production test.

TYPICAL CHARACTERISTICS

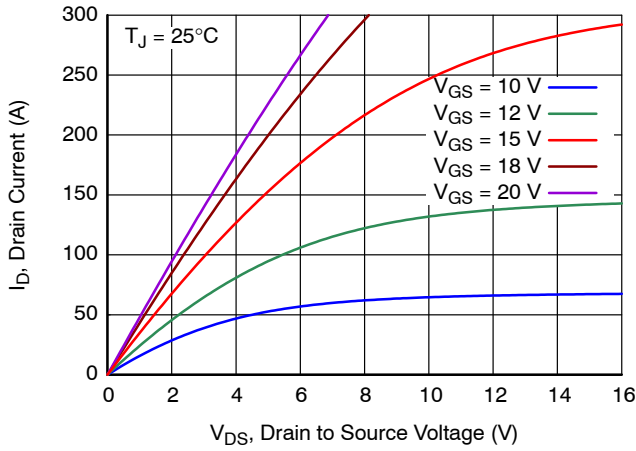

Figure 1. Output Characteristics

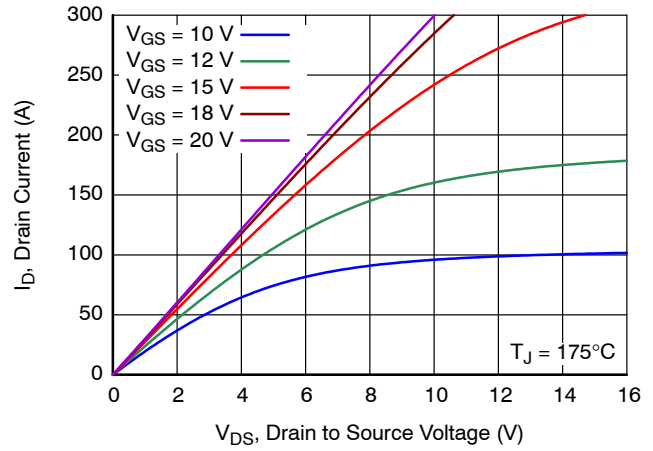

Figure 2. Output Characteristics

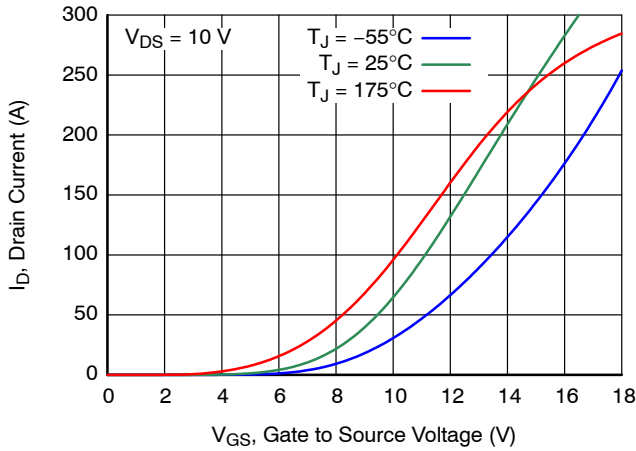

Figure 3. Transfer Characteristics

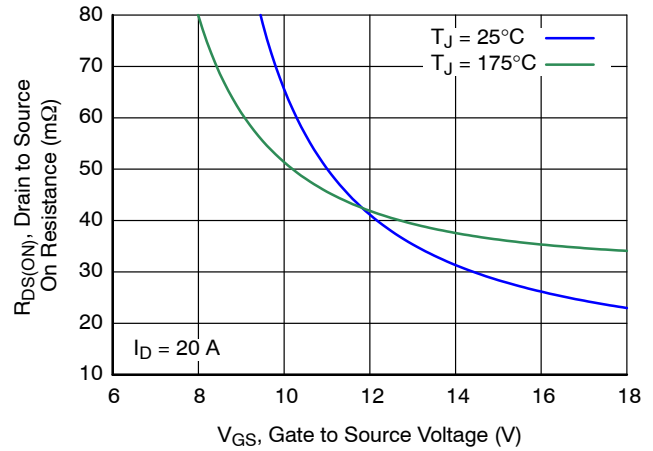

Figure 4. On-Resistance vs. Gate Voltage

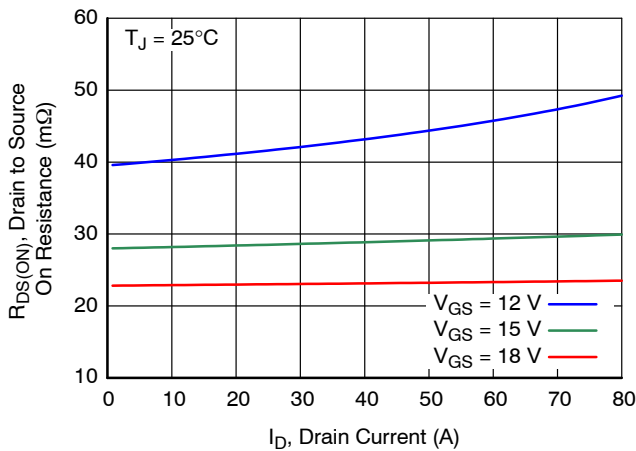

Figure 5. On-Resistance vs. Drain Current

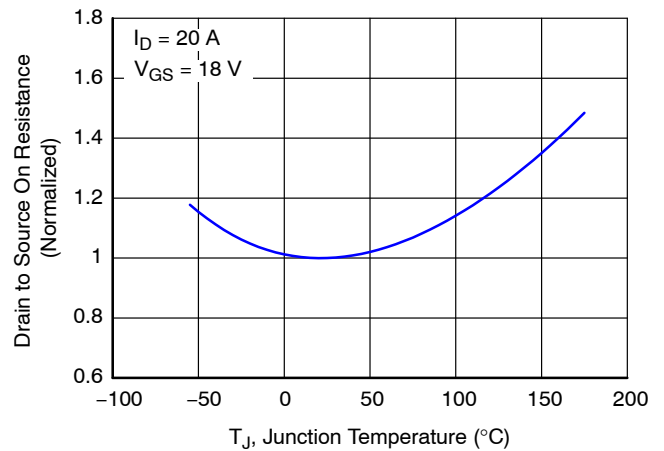

Figure 6. On-Resistance vs. Junction Temperature

NVBG023N065M3S

TYPICAL CHARACTERISTICS

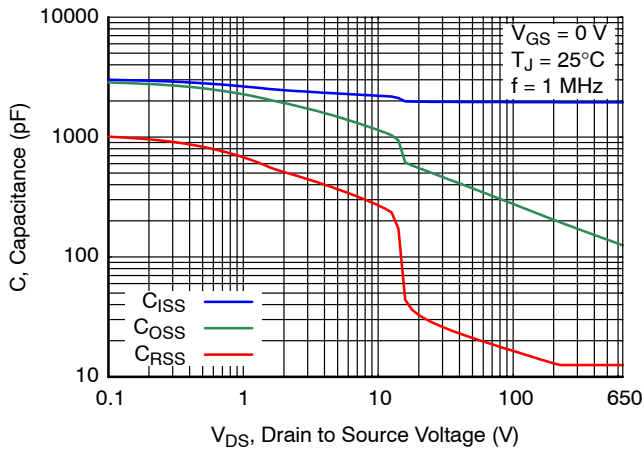

Figure 7. Capacitance Characteristics

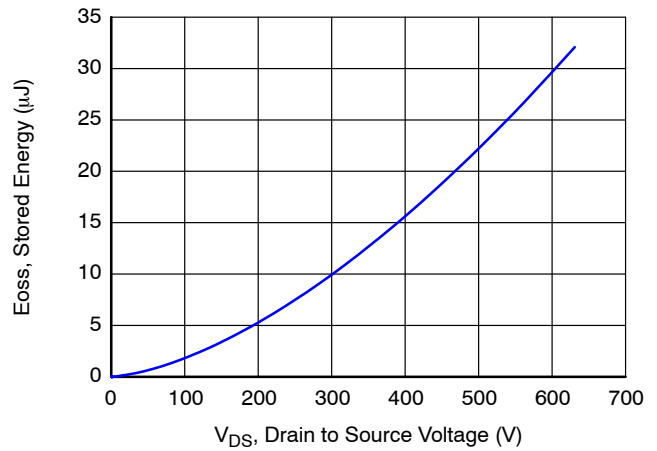

Figure 8. Stored Energy vs. Drain to Source Voltage

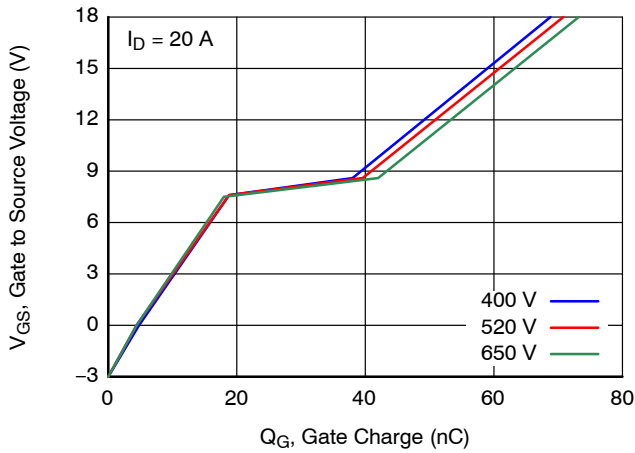

Figure 9. Gate Charge Characteristics

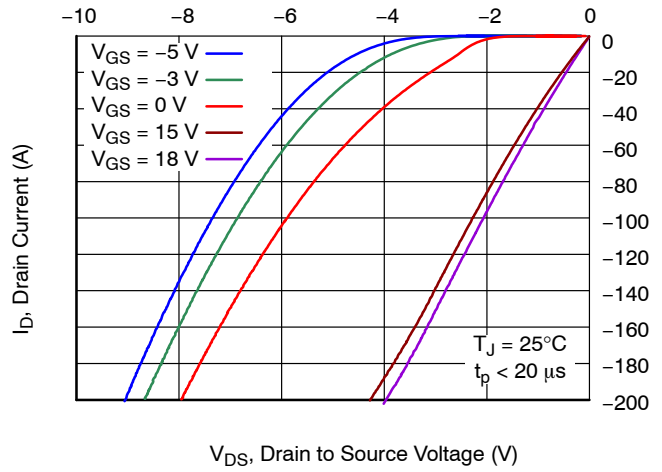

Figure 10. Reverse Conduction Characteristics

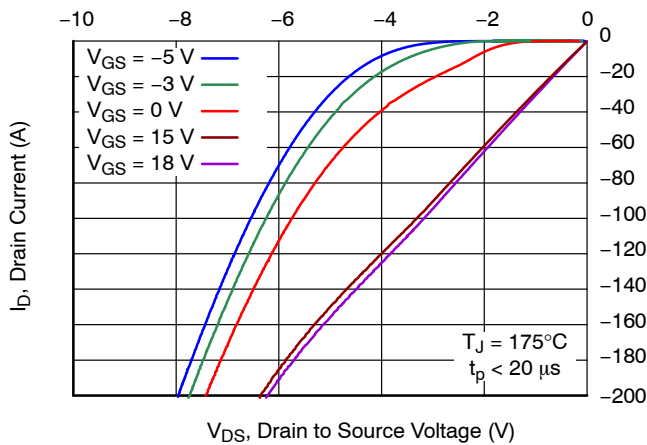

Figure 11. Reverse Conduction Characteristics

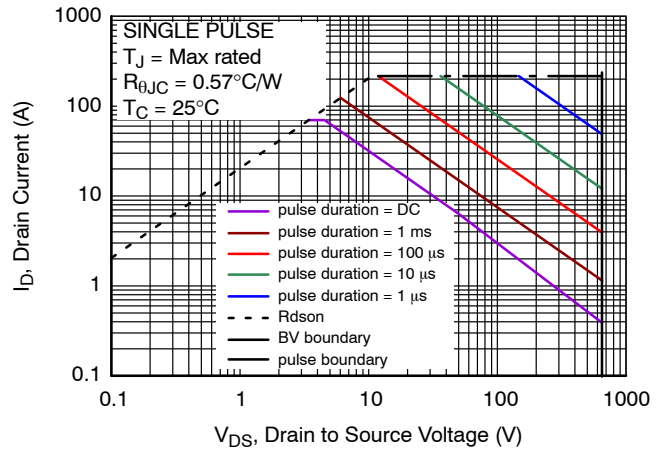

Figure 12. Safe Operating Area

NVBG023N065M3S

TYPICAL CHARACTERISTICS

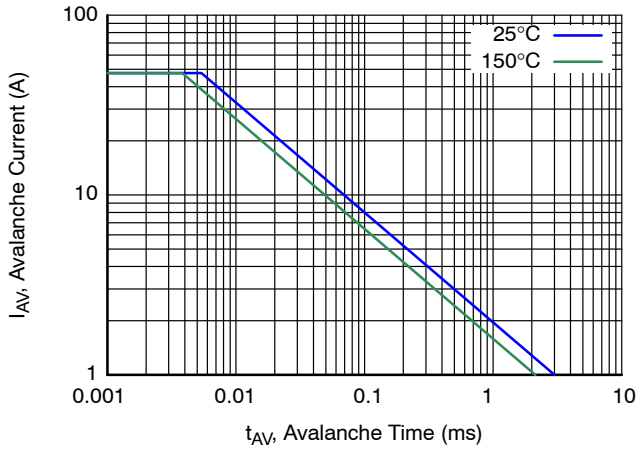

Figure 13. Avalanche Current vs. Pulse Time (UIS)

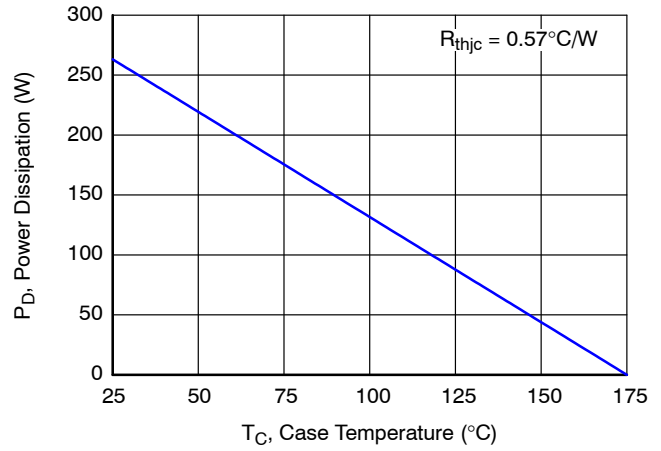

Figure 14. Maximum Power Dissipation vs. Case Temperature

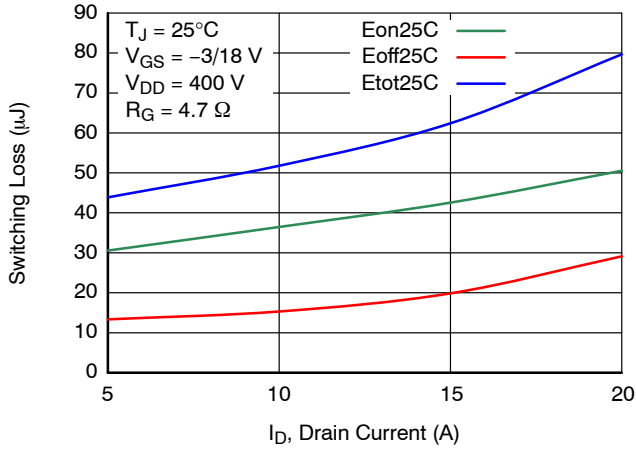

Figure 15. Inductive Switching Loss vs. Drain Current

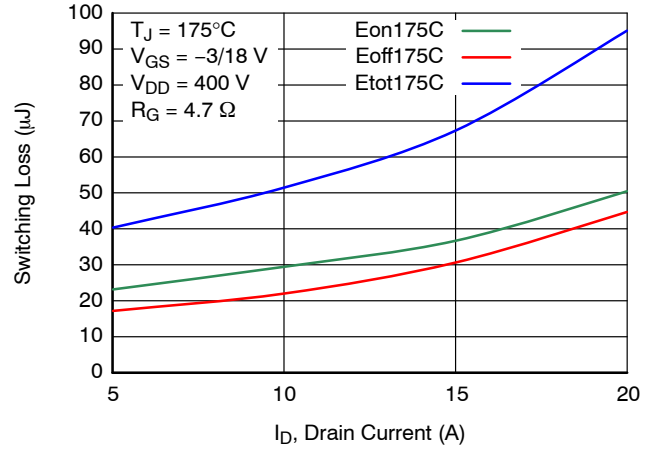

Figure 16. Inductive Switching Loss vs. Drain Current

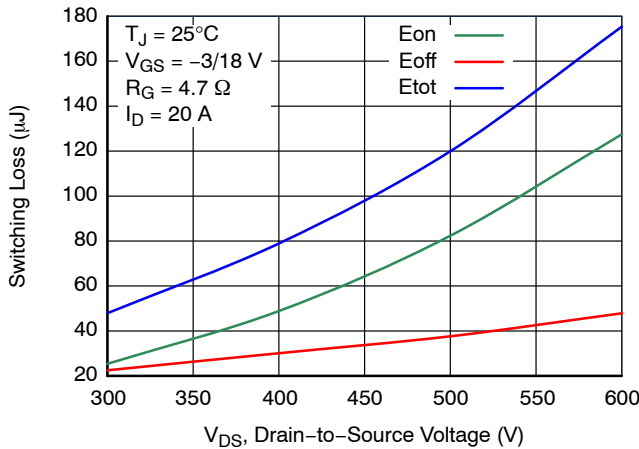

Figure 17. Inductive Switching Loss vs. Drain Voltage

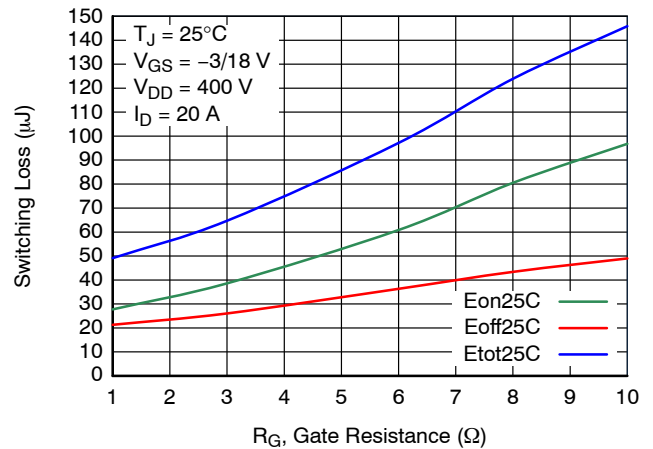

Figure 18. Inductive Switching Loss vs. Gate Resistance

NVBG023N065M3S

TYPICAL CHARACTERISTICS

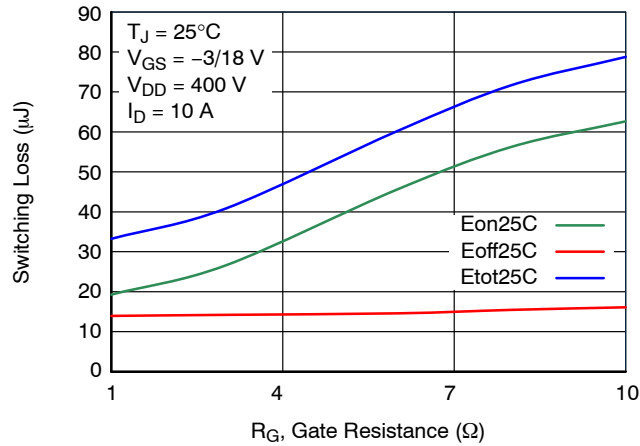

Figure 19. Inductive Switching Loss vs. Gate Resistance

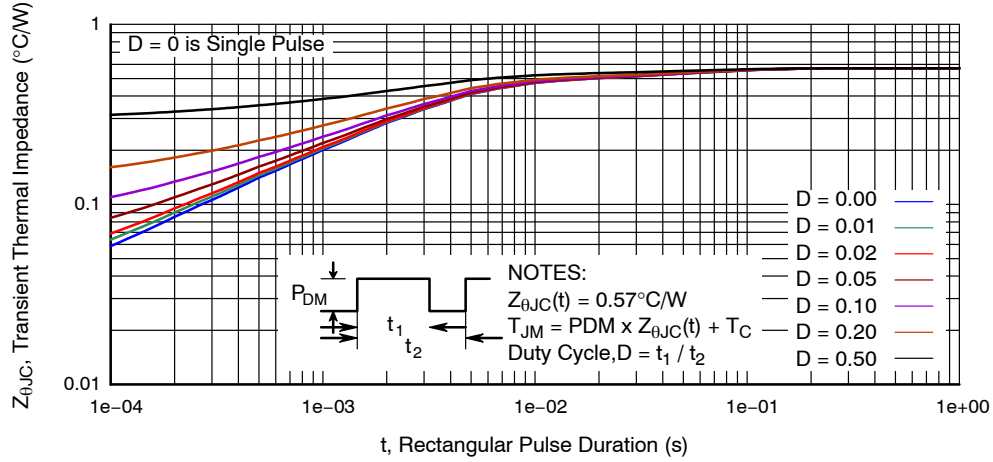
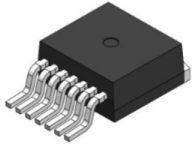
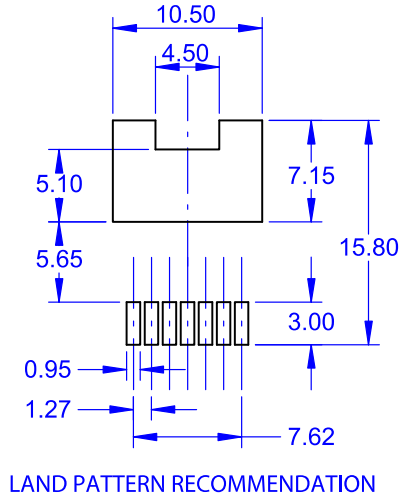
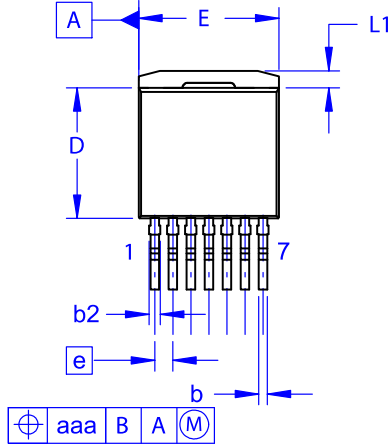

Figure 20. Thermal Response Characteristics



D²PAK7 (TO-263-7L HV)
CASE 418BJ
ISSUE B

DATE 16 AUG 2019



NOTES:

- A. PACKAGE CONFORMS TO JEDEC TO-263 VARIATION CB EXCEPT WHERE NOTED.
- B. ALL DIMENSIONS ARE IN MILLIMETERS.
- C. OUT OF JEDEC STANDARD VALUE.
- D. DIMENSION AND TOLERANCE AS PER ASME Y14.5-2009.
- E. DIMENSIONS ARE EXCLUSIVE OF BURRS, MOLD FLASH AND TIE BAR PROTRUSIONS.

DIM	MILLIMETERS		
	MIN	NOM	MAX
A	4.30	4.50	4.70
A1	0.00	0.10	0.20
b2	0.60	0.70	0.80
b	0.51	0.60	0.70
c	0.40	0.50	0.60
c2	1.20	1.30	1.40
D	9.00	9.20	9.40
D1	6.15	6.80	7.15
E	9.70	9.90	10.20
E1	7.15	7.65	8.15
e	~	1.27	~
H	15.10	15.40	15.70
L	2.44	2.64	2.84
L1	1.00	1.20	1.40
L3	~	0.25	~
aaa	~	~	0.25

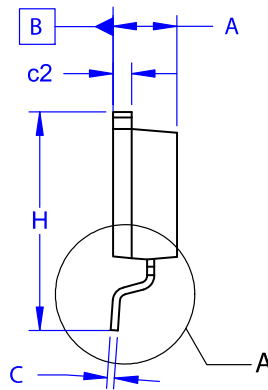
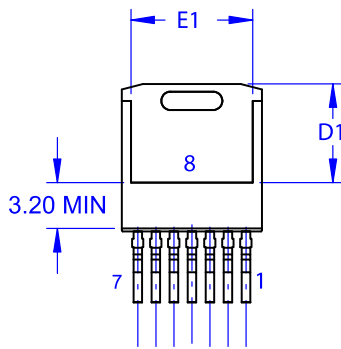

GENERIC MARKING DIAGRAM*

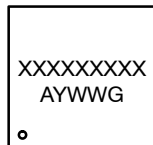

- XXXX = Specific Device Code
- A = Assembly Location
- Y = Year
- WW = Work Week
- G = Pb-Free Package

*This information is generic. Please refer to device data sheet for actual part marking. Pb-Free indicator, "G" or microdot "•", may or may not be present. Some products may not follow the Generic Marking.

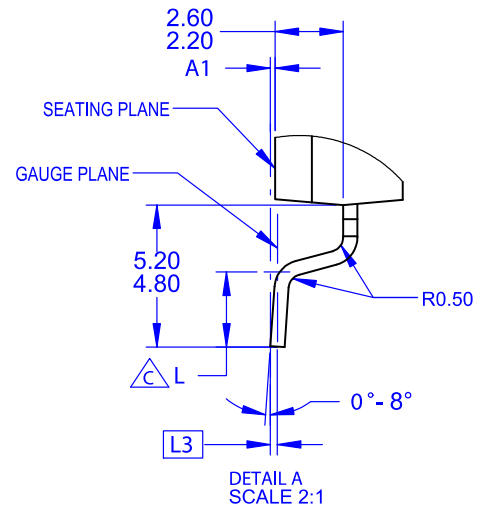

DOCUMENT NUMBER:	98AON84234G	Electronic versions are uncontrolled except when accessed directly from the Document Repository. Printed versions are uncontrolled except when stamped "CONTROLLED COPY" in red.
DESCRIPTION:	D²PAK7 (TO-263-7L HV)	PAGE 1 OF 1

onsemi and ONSEMI are trademarks of Semiconductor Components Industries, LLC dba onsemi or its subsidiaries in the United States and/or other countries. onsemi reserves the right to make changes without further notice to any products herein. onsemi makes no warranty, representation or guarantee regarding the suitability of its products for any particular purpose, nor does onsemi assume any liability arising out of the application or use of any product or circuit, and specifically disclaims any and all liability, including without limitation special, consequential or incidental damages. onsemi does not convey any license under its patent rights nor the rights of others.

onsemi, **Onsemi**, and other names, marks, and brands are registered and/or common law trademarks of Semiconductor Components Industries, LLC dba "**onsemi**" or its affiliates and/or subsidiaries in the United States and/or other countries. **onsemi** owns the rights to a number of patents, trademarks, copyrights, trade secrets, and other intellectual property. A listing of **onsemi**'s product/patent coverage may be accessed at www.onsemi.com/site/pdf/Patent-Marking.pdf. **onsemi** reserves the right to make changes at any time to any products or information herein, without notice. The information herein is provided "as-is" and **onsemi** makes no warranty, representation or guarantee regarding the accuracy of the information, product features, availability, functionality, or suitability of its products for any particular purpose, nor does **onsemi** assume any liability arising out of the application or use of any product or circuit, and specifically disclaims any and all liability, including without limitation special, consequential or incidental damages. Buyer is responsible for its products and applications using **onsemi** products, including compliance with all laws, regulations and safety requirements or standards, regardless of any support or applications information provided by **onsemi**. "Typical" parameters which may be provided in **onsemi** data sheets and/or specifications can and do vary in different applications and actual performance may vary over time. All operating parameters, including "Typicals" must be validated for each customer application by customer's technical experts. **onsemi** does not convey any license under any of its intellectual property rights nor the rights of others. **onsemi** products are not designed, intended, or authorized for use as a critical component in life support systems or any FDA Class 3 medical devices or medical devices with a same or similar classification in a foreign jurisdiction or any devices intended for implantation in the human body. Should Buyer purchase or use **onsemi** products for any such unintended or unauthorized application, Buyer shall indemnify and hold **onsemi** and its officers, employees, subsidiaries, affiliates, and distributors harmless against all claims, costs, damages, and expenses, and reasonable attorney fees arising out of, directly or indirectly, any claim of personal injury or death associated with such unintended or unauthorized use, even if such claim alleges that **onsemi** was negligent regarding the design or manufacture of the part. **onsemi** is an Equal Opportunity/Affirmative Action Employer. This literature is subject to all applicable copyright laws and is not for resale in any manner.

ADDITIONAL INFORMATION

TECHNICAL PUBLICATIONS:

Technical Library: www.onsemi.com/design/resources/technical-documentation
onsemi Website: www.onsemi.com

ONLINE SUPPORT: www.onsemi.com/support

For additional information, please contact your local Sales Representative at www.onsemi.com/support/sales