

24-Bit, 2 MSPS, μ Module Data-Acquisition Solution

FEATURES

- ▶ High Performance
 - ▶ Throughput: 2 MSPS, no latency
 - ▶ INL: ± 1 ppm maximum from -40 °C to 105 °C
 - ▶ Total system dynamic range: 128 dB typical
 - ▶ SNR: 106.5 dB typical, THD: -122 dB typical
 - ▶ Offset error drift: $+4.1$ μ V/°C maximum
 - ▶ Gain error drift: $+1.50$ ppm/°C maximum
- ▶ Ease of use features reduce system complexity
 - ▶ Second-order, 270 kHz anti-aliasing filter
 - ▶ High-Z PGIA gain options: 1/3, 5/9, 20/9, 20/3
 - ▶ Flexible external reference voltage: 4.096 V or 5 V
 - ▶ Differential Input Voltage ranges, \pm REFIN/Gain: ± 15 V, ± 9 V, ± 2.25 V, ± 0.75 V
 - ▶ Wide input common-mode voltage range: -8 V to $+10$ V
 - ▶ Low input bias current: -30 pA typical
- ▶ High density solution reduces system footprint
 - ▶ 14 mm \times 9 mm, 0.8 mm pitch, 178-ball CSP BGA
 - ▶ 4 \times footprint reduction vs. equivalent discrete solution
 - ▶ On-board reference buffer with an internal VCM generation

- ▶ Total power dissipation: 446 mW typical at 2 MSPS
- ▶ Electrically isolated, 1.8 V I²C-compatible temperature sensor
- ▶ Flexi-SPI digital interface
 - ▶ 1, 2, or 4 SDO lanes allows slower SCK
 - ▶ Echo clock mode simplifies use of digital isolator
 - ▶ Compatible with 1.2 V to 1.8 V logic
 - ▶ PGIA gain control (A0, A1) interface
 - ▶ Extended sample resolution to 30-bits
 - ▶ Overrange and synchronization bits

APPLICATIONS

- ▶ Automatic test equipment
- ▶ Machine automation
- ▶ Process controls
- ▶ Medical and industrial instrumentation
- ▶ Digital control loops

FUNCTIONAL BLOCK DIAGRAM

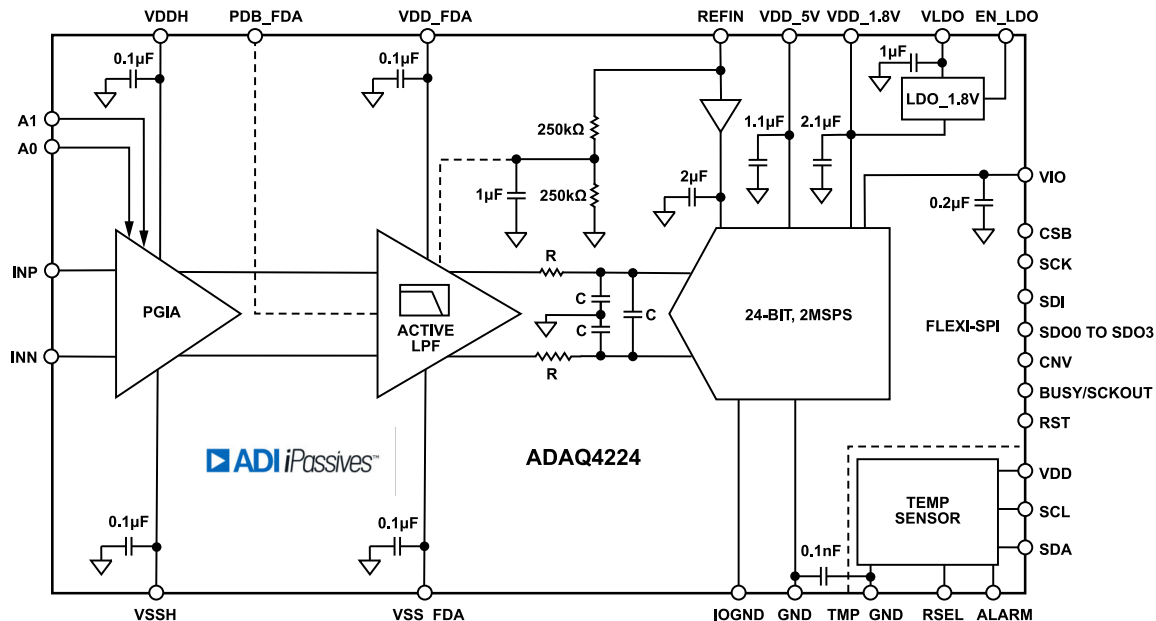

Figure 1. ADAQ4224 Functional Block Diagram

TABLE OF CONTENTS

Features.....	1	Registers.....	55
Applications.....	1	Register Details.....	56
Functional Block Diagram.....	1	Interface Configuration A Register.....	56
General Description.....	3	Interface Configuration B Register.....	56
Specifications.....	4	Device Configuration Register.....	57
Timing Specifications.....	8	Chip Type Register.....	57
Absolute Maximum Ratings.....	13	Product ID Low Register.....	57
Thermal Resistance.....	13	Product ID High Register.....	57
Electrostatic Discharge (ESD) Ratings.....	13	Chip Grade Register.....	58
ESD Caution.....	13	Scratch Pad Register.....	58
Pin Configurations and Function Descriptions.....	14	SPI Revision Register.....	58
Typical Performance Characteristics.....	16	Vendor ID Low Register.....	59
Terminology.....	28	Vendor ID High Register.....	59
Theory of Operation.....	29	Stream Mode Register.....	59
Overview.....	29	Interface Status A Register.....	59
Transfer Function.....	29	EXIT Configuration Mode Register.....	60
Signal Chain Operation.....	30	Averaging Mode Register.....	60
Digital Sample Processing Features.....	30	Offset Registers.....	60
Temperature Sensor Operation.....	31	Gain Registers.....	61
Applications Information.....	35	Modes Register.....	62
Typical Application Diagram.....	35	Internal Oscillator Register.....	62
Reference Circuitry Design.....	40	Output Driver Register.....	63
ADC Reset.....	41	Test Pattern Registers.....	63
Power Supplies.....	41	Digital Diagnostics Register.....	64
Serial Interface.....	43	Digital Errors Register.....	64
SPI Signals.....	43	Temperature Sensor Registers.....	65
Sample Conversion Timing and Data		Temperature Sensor Register Details.....	66
Transfer.....	45	Configuration and Status Register.....	66
Clocking Modes.....	46	Outline Dimensions.....	67
Data Clocking Requirements and Timing.....	49	Ordering Guide.....	67
Layout Guidelines.....	54	Evaluation Boards.....	67

REVISION HISTORY**9/2024—Revision 0: Initial Version**

GENERAL DESCRIPTION

The ADAQ4224 is a μ Module[®] precision data acquisition (DAQ) signal chain solution that reduces the development cycle of a precision measurement system by transferring the signal-chain design challenge of component selection, optimization, and layout from the designer to the device. With a guaranteed maximum ± 1.0 ppm INL and no missing codes at 24 bits, the ADAQ4224 achieves unparalleled precision performance from -40°C to $+105^{\circ}\text{C}$.

Using system-in-package (SIP) technology, the ADAQ4224 combines the common signal processing blocks required in a data acquisition solution in a small footprint, 14 mm \times 9 mm, 0.8 mm pitch, 178-ball CSP_BGA package.

The ADAQ4224 integrates the following:

- ▶ A low noise, high-bandwidth programmable gain instrumentation amplifier (PGIA).
- ▶ A second-order anti-aliasing filter.
- ▶ A low-noise, low-distortion, high-bandwidth ADC driver.
- ▶ A high precision 24-bit, 2 MSPS successive approximation register (SAR) ADC.
- ▶ An electrically isolated, I²C compatible temperature sensor with excellent accuracy of $\pm 1^{\circ}\text{C}$ maximum.
- ▶ A 1.8 V low dropout (LDO) regulator.
- ▶ Performance critical passives.

The ADAQ4224 incorporates the critical passive components with superior matching and drift characteristics using Analog Devices, Inc., iPassives[®] technology to minimize temperature-dependent error sources and to offer optimized performance. Integrating the

critical power supply and reference bypass capacitors reduce sensitivity to the system level board layout. Reducing the solution footprint enables addition of more functions within the system and hence the smaller form factor instruments without sacrificing performance.

The system integration solves many design challenges while the μ Module still provides the flexibility of a configurable PGIA: allowing gain or attenuation and supporting the acquisition of differential or single-ended input signal. The fast settling of the PGIA and ADC driver stage and no latency of the SAR ADC provide a unique solution for high channel count, multiplexed signal-chain architectures and control loop applications.

The digital features include Flexi-SPI serial-peripheral interface (SPI), which allow data access by multiple SPI modes as well as offset correction, gain adjustment, and averaging. The digital features reduces the burden on the host processor. A wide-data clocking window, multiple SDO lanes, and optional DDR data clocking reduce the serial clock frequency while operating at full speed of 2 MSPS and make it easier to isolate the DAQ solution, which reduces power dissipation and EMI. The echo clock mode and host clock mode of the ADAQ4224 relax the timing requirements and simplify the use of digital isolators.

The Flexi-SPI, PGIA gain control, and I²C-compatible temperature sensor serial-user interface is compatible with 1.2 V to 1.8 V, 2.5 V, 3 V, or 5 V logic, using a separate VIO supply. The ADAQ4224 operation is specified from -40°C to $+105^{\circ}\text{C}$.

SPECIFICATIONS

$V_{DDH} = 18\text{ V}$, $V_{SSH} = -18\text{ V}$, $V_{DD_FDA} = 5.4\text{ V}$, $V_{SS_FDA} = 0$, $V_{DD_5V} = 5.4\text{ V}$, $V_{LDO} = 5.4\text{ V}$, $V_{IO} = 1.8\text{ V}$, $V_{DD} = 3.3\text{ V}$, $REFIN = 5\text{ V}$, sampling frequency (f_s) = 2 MSPS, all gains, and all specifications T_{MIN} to T_{MAX} , unless otherwise noted.

Table 1. Specifications

Parameter	Test Conditions/Comments	Min	Typ	Max	Unit
RESOLUTION		24			Bits
DIFFERENTIAL INPUT VOLTAGE RANGE, V_{IN}	$V_{IN} = \pm REFIN/Gain$				
	Gain = 1/3	-15		+15	V
	Gain = 5/9	-9		+9	V
	Gain = 20/9	-2.25		+2.25	V
	Gain = 20/3	-0.75		+0.75	V
Analog Front-End Gain (G)	A0 = low, A1 = low		1/3		V/V
	A0 = high, A1 = low		5/9		V/V
	A0 = low, A1 = high		20/9		V/V
	A0 = high, A1 = high		20/3		V/V
Input Common-Mode Voltage Range	All gains	-8		+10	V
Common-Mode Rejection Ratio (CMRR)	DC		95		dB
Input Current ¹	INP, INN, $T_A = 25^\circ\text{C}$	-130	-30	+75	pA
Input Resistance	INP, INN		10^{12}		Ω
Input Capacitance	INP, INN		22		pF
THROUGHPUT					
Complete Cycle		500			ns
Conversion Time		264	282	300	ns
Acquisition Phase ²		244	260	275	ns
Throughput Rate		0		2	MSPS
DC ACCURACY					
No Missing Codes		24			Bits
Integral Nonlinearity Error (INL) ¹	All gains. $V_{SS_FDA} = 0\text{ V}$	-1	± 0.4	+1	ppm
Differential Nonlinearity Error (DNL) ¹	All gains		± 0.5		LSB
Transition Noise	G = 1/3		73.33		LSBrms
	G = 5/9		45.02		LSBrms
	G = 20/9		13.37		LSBrms
	G = 20/3		6.67		LSBrms
Offset Error	G = 1/3	-0.8	± 0.10	+0.8	mV
	G = 5/9	-0.8	± 0.11	+0.8	mV
	G = 20/9	-0.95	± 0.13	+0.95	mV
	G = 20/3	-1.4	± 0.23	+1.4	mV
Offset Error Drift	$T = -40^\circ\text{C}$ to $+105^\circ\text{C}$, End point method				
	G = 1/3, 5/9, 20/9	-7.1	± 1.7	+4.1	$\mu\text{V}/^\circ\text{C}$
	G = 20/3	-9.2	± 1.2	+6.8	$\mu\text{V}/^\circ\text{C}$
Gain Error	$REFIN = 5\text{ V}$	-0.06	± 0.006	+0.06	%FS
Gain Error Drift	$T = -40^\circ\text{C}$ to $+105^\circ\text{C}$, End point method				
	All gains	-1.25	0.1	1.50	ppm/ $^\circ\text{C}$
Power-Supply Rejection Ratio (PSRR)	$V_{DDH} = +15\text{ V}$ to $+18\text{ V}$ step		122		dB
	$V_{SSH} = -15\text{ V}$ to -18 V step		129		dB
	$V_{DD_FDA} = +4.5\text{ V}$ to $+5.5\text{ V}$ step		109		dB
	$V_{SS_FDA} = 0\text{ V}$ to -1 V step		104		dB
	$V_{DD_5V} = +5.3\text{ V}$ to $+5.5\text{ V}$ step		109		dB
	$V_{LDO} = +5.3\text{ V}$ to $+5.5\text{ V}$ step		113		dB
Low Frequency Noise ³	Referred to input, bandwidth = 0.1 Hz to 10 Hz, all gains		6		μV p-p

SPECIFICATIONS

Table 1. Specifications (Continued)

Parameter	Test Conditions/Comments	Min	Typ	Max	Unit
AC ACCURACY					
Dynamic Range	G = 1/3		107.7		dB
	G = 5/9		107.5		dB
	G = 20/9		106		dB
	G = 20/3		102.5		dB
Total-System Dynamic Range			128		dB
Noise Spectral Density (NSD)	$f_{IN} = 10$ kHz				
	G = 1/3		67.12		nV/ $\sqrt{\text{Hz}}$
	G = 5/9		41.21		nV/ $\sqrt{\text{Hz}}$
	G = 20/9		12.72		nV/ $\sqrt{\text{Hz}}$
Total RMS Noise, RTI	G = 20/3		6.69		nV/ $\sqrt{\text{Hz}}$
	G = 1/3		43.7		$\mu\text{V RMS}$
	G = 5/9		26.8		$\mu\text{V RMS}$
	G = 20/9		8		$\mu\text{V RMS}$
Signal-to-Noise Ratio (SNR)	G = 20/3		4		$\mu\text{V RMS}$
	$f_{IN} = 1$ kHz, -0.5 dBFS				
	G = 1/3	105	106.5		dB
	G = 5/9	104	106		dB
Spurious-Free Dynamic Range (SFDR)	G = 20/9	103.2	105		dB
	G = 20/3	98.8	101		dB
	$f_{IN} = 1$ kHz, -0.5 dBFS				
	G = 1/3		122		dB
Total Harmonic Distortion (THD)	G = 5/9		118		dB
	G = 20/9		122		dB
	G = 20/3		122		dB
	$f_{IN} = 1$ kHz, -0.5 dBFS				
Signal-to-Noise-and-Distortion (SINAD) Ratio	G = 1/3	-114.5	-122		dB
	G = 5/9	-106	-118		dB
	G = 20/9	-116	-122		dB
	G = 20/3	-116	-122		dB
Oversampled Dynamic Range	$f_{IN} = 1$ kHz, -0.5 dBFS				
	G = 1/3	104.7	106.4		dB
	G = 5/9	103.7	105.9		dB
	G = 20/9	103	104.9		dB
-3 dB Input Bandwidth	G = 20/3	98.6	100.9		dB
	OSR = 2		108		dB
Aperture Delay	OSR = 1024		134		dB
	$V_{OUTDIFF} = 2$ V p-p				
	G = 1/3		270		kHz
	G = 5/9		270		kHz
Aperture Jitter	G = 20/9		250		kHz
	G = 20/3		225		kHz
INTERNAL REFERENCE BUFFER					
REFIN Voltage Range	External reference drives REFIN				
	$5.3 \text{ V} \leq V_{DD_5V} \leq 5.5 \text{ V}$	4.95	5	5.05	V
REFIN Bias Current	$4.75 \text{ V} \leq V_{DD_5V} \leq 5.25 \text{ V}$	4.046	4.096	4.146	V
	REFIN = 5 V		10	13.5	μA
REFIN Input Impedance			500		k Ω

SPECIFICATIONS

Table 1. Specifications (Continued)

Parameter	Test Conditions/Comments	Min	Typ	Max	Unit
REFIN Input Capacitance			40		pF
Reference Buffer Offset-Error	REFIN = 5 V or 4.096 V, T _A = 25°C	-150	±20	+150	μV
Reference Buffer Offset-Drift			±0.3		μV/°C
Power-On Settling Time			3		ms
DIGITAL INPUTS, ADC	1.14 V ≤ V _{IO} ≤ 1.89 V				
Logic Levels					
Input Voltage Low (V _{IL})		-0.3		+0.35 × V _{IO}	V
Input Voltage High (V _{IH})		0.65 × V _{IO}		V _{IO} + 0.3	V
Input Current Low (I _{IL})		-10		+10	μA
Input Current High (I _{IH})		-10		+10	μA
Input Pin Capacitance			2		pF
DIGITAL INPUTS, A0 and A1					
Logic Levels					
Input Voltage Low (V _{IL})		2			V
Input Voltage High (V _{IH})				0.8	V
Input Current (I _{IL} or I _{IH})			0.002		μA
Input Pin Capacitance			2		pF
DIGITAL INPUTS, FDA					
PDB_FDA Input Current	PDB_FDA = VDD_FDA or 0 V		50		μA
DIGITAL INPUTS, TEMPERATURE SENSOR (SDA AND SCL)					
Logic Levels					
Input Voltage Low (V _{IL})	V _{DD} = 3.3 V	-0.5		V _{DD} × 0.3	V
Input Voltage High (V _{IH})		V _{DD} × 0.7		3.6	V
Input High-Leakage Current				+1	μA
Input Low-Leakage Current		-1	±0.005	+1	μA
Input Capacitance			5		pF
DIGITAL OUTPUTS	1.14 V ≤ V _{IO} ≤ 1.89 V				
Pipeline Delay					
Output Voltage Low (V _{OL})	Sink current (I _{SINK}) = 2 mA			0.25 × V _{IO}	V
Output Voltage High (V _{OH})	Source current (I _{SOURCE}) = 2 mA	0.75 × V _{IO}			V
LDO CHARACTERISTICS					
VDD_1.8V Output Voltage		1.71	1.8	1.89	V
Load Regulation	Output current (I _{OUT}) = 1 mA to 100 mA		0.003		%/mA
Dropout Voltage ⁴	I _{OUT} = 100 mA		45		mV
Start-up Time ⁵			200		μs
Current Limit Threshold			260		mA
EN_LDO Input Current	EN_LDO = V _{LDO}		0.001	1	μA
Thermal Shutdown Threshold			150		°C
Thermal Shutdown Hysteresis			15		°C
TEMPERATURE SENSOR CHARACTERISTICS					
Temperature Measurement Error	T = -40°C to +105°C	-1	±0.3	+1	°C
Conversion Time	10-bit resolution, T = 25°C		35	150	ms
Temperature Resolution	12-bit (Configuration Bits[D6:D5] = 11)		0.0625		°C
	10-bit (Configuration Bits[D6:D5] = 10)		0.25		°C

SPECIFICATIONS

Table 1. Specifications (Continued)

Parameter	Test Conditions/Comments	Min	Typ	Max	Unit
First Conversion Completed	9-bit (Configuration Bits[D6:D5] = 01)		0.5		°C
	8-bit (Configuration Bits[D6:D5] = 00)		1.0		°C
	After V _{DD} exceeds 1.6 V			500	ms
ISOLATION LEAKAGE CURRENT	±250 V between GND and TMP_GND planes		1		nA
POWER SUPPLIES					
V _{DDH}			18		V
V _{SSH}			-18		V
VDD_FDA		3	5.4	VSS_FDA + 10	V
VSS_FDA		VDD_FDA - 10	0	+0.1	V
VDD_5V	REF = 5 V	5.3	5.4	5.5	V
	REF = 4.096 V	4.75	5	5.25	V
VDD_1.8V		1.71	1.8	1.89	V
V _{IO} ⁶		1.14		1.89	V
VDD		3.0	3.3	3.6	V
VLDO		2.2	5.4	5.5	V
Standby Current	Inputs grounded				
V _{DDH}			8		mA
V _{SSH}			-9		mA
VDD_FDA			4.8		mA
VSS_FDA			-3.5		mA
VDD_5V			525		μA
V _{IO}			<1		μA
V _{DD}			1.5	4.5	μA
V _{LDO}			108		μA
Shutdown Current	Inputs grounded				
VDD_FDA	PDB_FDA = 0 V		32		μA
VSS_FDA	PDB_FDA = 0 V		25.5		μA
VDD_5V	ADC in Shutdown Mode		5		μA
V _{IO}			<1		μA
V _{LDO}	EN_LDO = 0 V, ADC in shutdown mode		0.8		μA
Operating Current	2 MSPS, Input = -0.5 dBFS				
V _{DDH}	V _{DDH} = +18 V		10		mA
V _{SSH}	V _{SSH} = -18 V		-9.8		mA
VDD_5V	VDD_5V = 5.4 V		2.5	3.2	mA
VDD_FDA	VDD_FDA = 5 V		5.6	7.5	mA
VSS_FDA	VSS_FDA = 0 V	-7.5	-5.6		mA
V _{IO}	V _{IO} = 1.8 V, 1-lane SDO		1.3		mA
V _{LDO}	V _{LDO} = 5.4 V		8.2	10.5	mA
V _{DD}	V _{DD} = 3.3 V		80	150	μA
Power Dissipation	2 MSPS		446		mW
t _{RESET_DELAY}	After power-on, delay from VDD_5V and VDD_1.8V valid to RST assertion	3			ms
t _{RESET_PW}	RST pulse width	50			ns
TEMPERATURE RANGE					
Specified Performance	T _{MIN} to T _{MAX}	-40		+105	°C

¹ These specifications are not production tested but are supported by characterization data during the initial product release.

SPECIFICATIONS

- ² The acquisition phase is the time available for the input sampling capacitors to acquire a new input with the ADC running at a throughput rate of 2 MSPS.
- ³ See the low-frequency noise plot in [Figure 61](#). $1/f$ noise is canceled internally by auto-zeroing. Noise spectral density is substantially uniform from DC to $f_s/2$.
- ⁴ Dropout voltage is defined as the input-to-output voltage differential when the input voltage is set to the nominal output voltage.
- ⁵ Start-up time is defined as the time between the rising edge of EN_LDO to VDD_1.8V being at 90% of its nominal value.
- ⁶ When $V_{IO} < 1.4$ V, Bit IO2X must be set to 1. For more details, see the [Output Driver Register](#) section.

TIMING SPECIFICATIONS

$V_{DDH} = 18$ V, $V_{SSH} = -18$ V, $V_{DD_FDA} = 5.4$ V, $V_{SS_FDA} = 0$ V, $V_{DD_5V} = 5.4$ V, $V_{LDO} = 5.4$ V, $V_{IO} = 1.8$ V, $REFIN = 5$ V, $V_{DD} = 3.3$ V, $f_s = 2$ MSPS and all specifications are T_{MIN} to T_{MAX} , unless otherwise noted. For the timing voltage levels, see [Figure 2](#). For $V_{IO} < 1.4$ V, Bit IO2X must be set to 1.

Table 2. Digital Timing Interface

Parameter ¹	Symbol	Min	Typ	Max	Unit
Conversion Time: CNV Rising Edge to Data Available	t_{CONV}	264	282	300	ns
Acquisition Phase ²	t_{ACQ}	244	260	275	ns
Time Between Conversions	t_{CYC}	500			ns
CNV High Time	t_{CNVH}	10			ns
CNV Low Time	t_{CNVL}	20			ns
Internal Oscillator Frequency	f_{OSC}	75.1	80	84.7	MHz

¹ Timing specifications assume a 5 pF load capacitance on digital output pins. t_{CONV} , t_{CYC} , t_{SCK} , and t_{SCKOUT} are production tested. All other timing specifications are guaranteed by characterization and design.

² The acquisition phase is the time available for the input sampling capacitors to acquire a new input with the ADC running at a throughput rate of 2 MSPS.

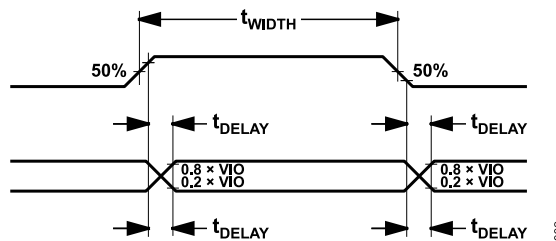

Figure 2. Voltage Levels for Timing

Table 3. Register Read/Write Timing

Parameter	Symbol	Min	Typ	Max	Unit
\overline{CS} Pulse Width	t_{CSPW}	10			ns
SCK Period	t_{SCK}				
$V_{IO} > 1.71$ V		11.6			ns
$V_{IO} > 1.14$ V		12.3			ns
SCK Low Time	t_{SCKL}	5.2			ns
SCK High Time	t_{SCKH}	5.2			ns
SCK Falling Edge to Data Remains Valid	t_{HSDO}	2.1			ns
SCK Falling Edge to Data Valid Delay	t_{DSDO}				
$V_{IO} > 1.71$ V				9.4	ns
$V_{IO} > 1.14$ V				11.8	ns
\overline{CS} Rising Edge to SDO High Impedance	t_{CSDIS}			9	ns
SDI Valid Setup Time to SCK Rising Edge	t_{SSDI}	1.5			ns
SDI Valid Hold Time from SCK Rising Edge	t_{HSDI}	1.5			ns
\overline{CS} Falling Edge to First SCK Rising Edge	t_{CSSCK}				

SPECIFICATIONS

Table 3. Register Read/Write Timing (Continued)

Parameter	Symbol	Min	Typ	Max	Unit
$V_{IO} > 1.71\text{ V}$		11.6			ns
$V_{IO} > 1.14\text{ V}$		12.3			ns
Last SCK Edge to $\overline{\text{CS}}$ Rising Edge	t_{SCKCS}	5.2			ns

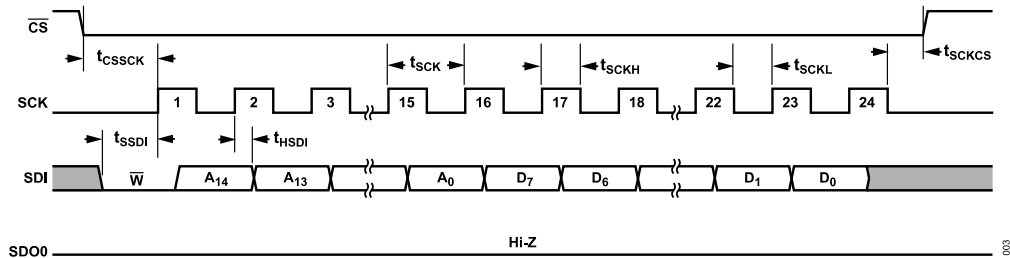

Figure 3. Register Configuration Mode Write Timing

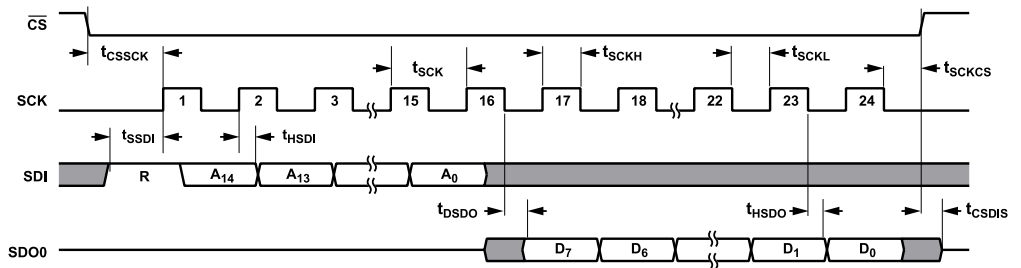

Figure 4. Register Configuration Mode Read Timing

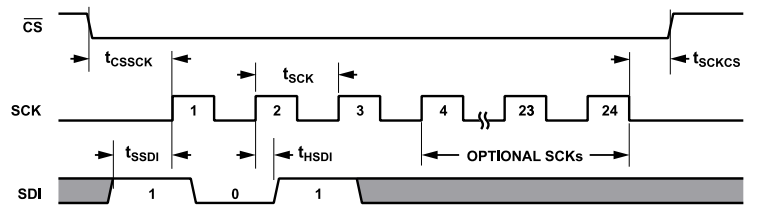

Figure 5. Register Configuration Mode Command Timing

Table 4. SPI-Compatible Mode Timing

Parameter	Symbol	Min	Typ	Max	Unit
SCK Period	t_{SCK}	9.8			ns
$V_{IO} > 1.71\text{ V}$		12.3			ns
$V_{IO} > 1.14\text{ V}$					ns
SCK Low Time	t_{SCKL}	4.2			ns
$V_{IO} > 1.71\text{ V}$		5.2			ns
$V_{IO} > 1.14\text{ V}$					ns
SCK High Time	t_{SCKH}	4.2			ns
$V_{IO} > 1.71\text{ V}$		5.2			ns
$V_{IO} > 1.14\text{ V}$					ns
SCK Falling Edge to Data Remains Valid	t_{HSDO}	1.4			ns
SCK Falling Edge to Data Valid Delay	t_{DSDO}			5.6	ns
$V_{IO} > 1.71\text{ V}$				8.1	ns
$V_{IO} > 1.14\text{ V}$					ns

SPECIFICATIONS

Table 4. SPI-Compatible Mode Timing (Continued)

Parameter	Symbol	Min	Typ	Max	Unit
\overline{CS} Falling Edge to SDO Valid	t_{CSEN}				ns
$V_{IO} > 1.71\text{ V}$				6.8	ns
$V_{IO} > 1.14\text{ V}$				9.3	ns
\overline{CS} Falling Edge to First SCK Rising Edge	t_{CSSCK}				
$V_{IO} > 1.71\text{ V}$		9.8			ns
$V_{IO} > 1.14\text{ V}$		12.3			ns
Last SCK Edge to \overline{CS} Rising Edge	t_{SCKCS}	4.2			ns
\overline{CS} Rising Edge to SDO High Impedance	t_{CSDIS}			9	ns
\overline{CS} Falling Edge to BUSY Rising Edge	t_{CSBUSY}		6		ns

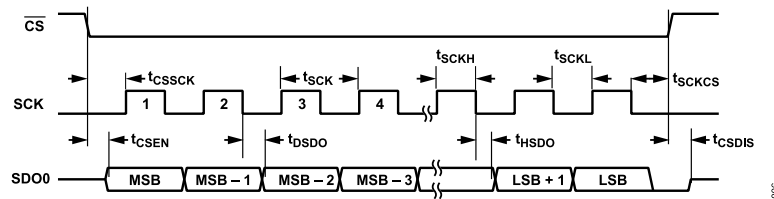

Figure 6. SPI Clcking Mode 1-Lane SDR Timing

Table 5. Echo-Clock Mode Timing, SDR, 1-Lane

Parameter	Symbol	Min	Typ	Max	Unit
SCK Period	t_{SCK}	9.8			ns
$V_{IO} > 1.71\text{ V}$		12.3			ns
$V_{IO} > 1.14\text{ V}$					ns
SCK Low Time, SCK High Time	t_{SCKL}, t_{SCKH}	4.2			ns
$V_{IO} > 1.71\text{ V}$		5.2			ns
$V_{IO} > 1.14\text{ V}$					ns
SCK Rising Edge to Data/SCKOUT Remains Valid	t_{HSDO}	1.1			ns
SCK Rising Edge to Data/SCKOUT Valid Delay	t_{DSDO}			5.6	ns
$V_{IO} > 1.71\text{ V}$				8.1	ns
$V_{IO} > 1.14\text{ V}$					ns
\overline{CS} Falling Edge to First SCK Rising Edge	t_{CSSCK}	9.8			ns
$V_{IO} > 1.71\text{ V}$		12.3			ns
$V_{IO} > 1.14\text{ V}$					ns
Skew Between Data and SCKOUT	t_{SKEW}	-0.4	0	+0.4	ns
Last SCK Edge to \overline{CS} Rising Edge	t_{SCKCS}	4.2			ns
\overline{CS} Rising Edge to SDO High Impedance	t_{CSDIS}			9	ns

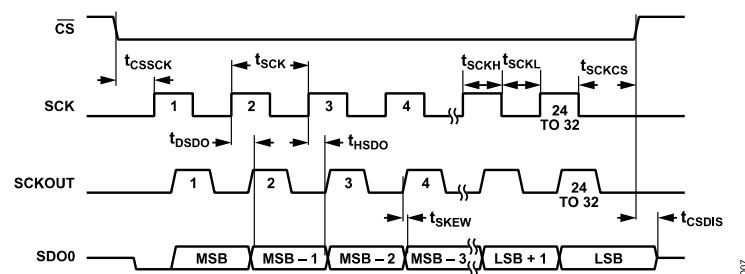

Figure 7. Echo-Clock Mode Timing, SDR, 1-Lane

SPECIFICATIONS

Table 6. Echo-Clock Mode Timing, DDR, 1-Lane

Parameter	Symbol	Min	Typ	Max	Unit
SCK Period	t_{SCK}	12.3			ns
SCK Low Time, SCK High Time	t_{SCKL} , t_{SCKH}	5.2			ns
SCK Edge to Data/SCKOUT Remains Valid	t_{HSDO}	1.1			ns
SCK Edge to Data/SCKOUT Valid Delay	t_{DSDO}				ns
$V_{IO} > 1.71$ V				6.2	ns
$V_{IO} > 1.14$ V				8.7	ns
\overline{CS} Falling Edge to First SCK Rising Edge	t_{CSSCK}	12.3			ns
Skew Between Data and SCKOUT	t_{SKEW}	-0.4	0	+0.4	ns
Last SCK Edge to \overline{CS} Rising Edge	t_{SCKCS}	9			ns
\overline{CS} Rising Edge to SDO High Impedance	t_{CSDIS}			9	ns

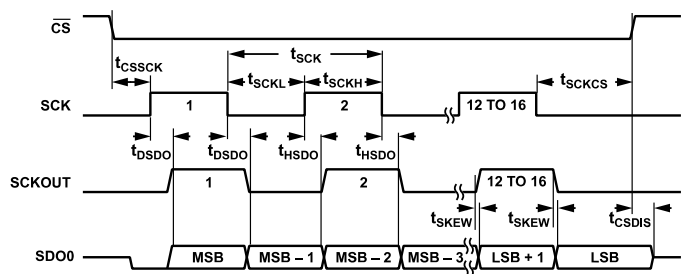

Figure 8. Echo-Clock Mode Timing, DDR, 1-Lane

Table 7. Host-Clock Mode Timing

Parameter	Symbol	Min	Typ	Max	Unit
SCK Period	t_{SCKOUT}	11.8	12.5	13.3	ns
OSC_DIV = No Divide		23.6	25	26.6	ns
OSC_DIV = Divide by 2		47.4	50	53.2	ns
OSC_DIV = Divide by 4					ns
SCK Low Time	$t_{SCKOUTL}$	$0.45 \times t_{SCKOUT}$		$0.55 \times t_{SCKOUT}$	ns
SCK High Time	$t_{SCKOUTH}$	$0.45 \times t_{SCKOUT}$		$0.55 \times t_{SCKOUT}$	ns
\overline{CS} Falling Edge to First SCKOUT Rising Edge	$t_{DSCKOUT}$	10	13.6	19	ns
$V_{IO} > 1.71$ V		10	15	21	ns
$V_{IO} > 1.14$ V					ns
Skew Between Data and SCKOUT	t_{SKEW}	-0.4	0	+0.4	ns
Last SCKOUT Edge to \overline{CS} Rising Edge	$t_{SCKOUTCS}$	5.2			ns
\overline{CS} Rising Edge to SDO High Impedance	t_{CSDIS}			9	ns

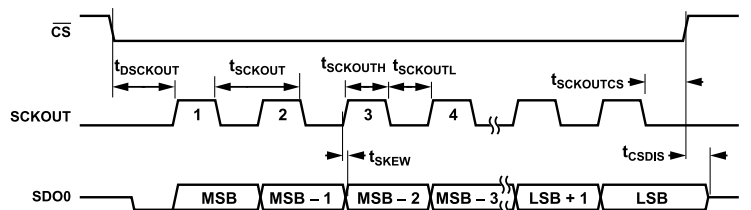

Figure 9. Host-Clock Mode Timing, SDR, 1-Lane

SPECIFICATIONS

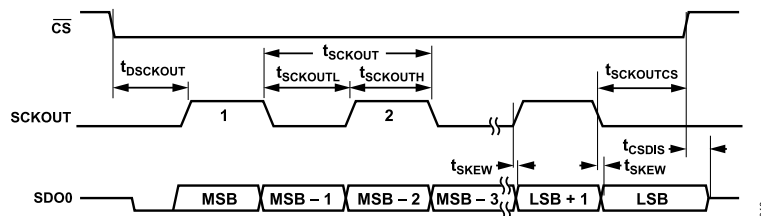

Figure 10. Host-Clock Mode Timing, DDR, 1-Lane

Table 8. Temperature Sensor I²C Timing

Parameter	Symbol	Min	Typ	Max	Unit
Serial Clock Frequency	f_{SCL}	20		1M	Hz
Bus Free Time Between Start and Stop Conditions	t_{BUF}	0.5			μ s
START Condition Hold Time	$t_{HD:STA}$	0.26			μ s
STOP Condition Setup Time ¹	$t_{SU:STO}$	0.26			μ s
Clock Low Period	t_{LOW}	0.5			μ s
Clock High Period	t_{HIGH}	0.26			μ s
Start Condition Setup Time ²	$t_{SU:STA}$	0.26			μ s
Data Setup Time ³	$t_{SU:DAT}$	50			ns
Data In Hold Time ⁴	$t_{HD:DAT}$	0			μ s
SCL/SDA Rise Time	t_R			120	ns
SCL/SDA Fall Time ⁵	t_F	$20 \times (V_{DD}/5.5 V)$		120	ns
SCL Time Low for Reset of Serial Interface ⁶	$t_{TIMEOUT}$	10		85	ms

¹ 90% of SCL to 10% of SDA.

² 90% of SCL to 90% of SDA.

³ 10% of SDA to 10% of SCL.

⁴ 10% of SCL to 10% of SDA.

⁵ C_B = total capacitance of one bus line in pF. Tested with $C_B = 400$ pF.

⁶ Holding the SCL line low for a time greater than $t_{TIMEOUT}$ causes the device to reset SDA to the idle state of the serial bus communication (SDA released).

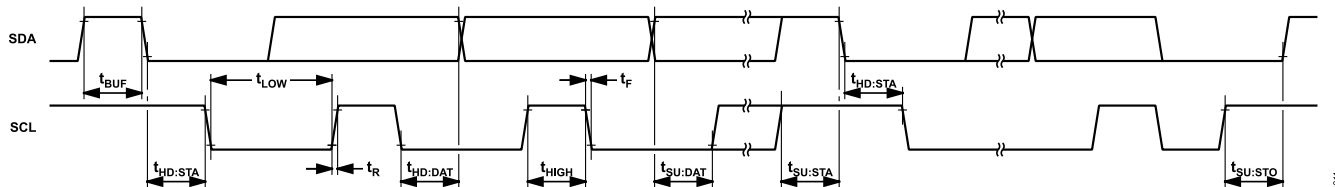

Figure 11. Temperature Sensor I²C Timing Diagram

ABSOLUTE MAXIMUM RATINGS

Table 9. Absolute Maximum Ratings

Parameter	Rating
Analog Inputs	
Input Voltage, INP, INN	$V_{SSH} - 0.2\text{ V to }V_{DDH} + 0.2\text{ V}$
REFIN to GND	$-0.3\text{ V to }V_{DD_5V} + 0.3\text{ V}$
Input Current ¹	$\pm 20\text{ mA}$
Supply Voltage	
V_{DDH} to V_{SSH}	40 V
V_{DD_FDA} to GND	11 V
V_{DD_5V} to GND	$-0.3\text{ V to }+6.0\text{ V}$
V_{IO} to GND	$-0.3\text{ V to }+2.1\text{ V}$
V_{LDO} to GND	$-0.3\text{ V to }+6.5\text{ V}$
V_{DD} to TMP_GND	$-0.3\text{ V to }+4\text{ V}$
Digital Inputs to GND	$-0.3\text{ V to }V_{IO} + 0.3\text{ V}$
CNV to GND	$-0.3\text{ V to }V_{IO} + 0.3\text{ V}$
RSEL, ALARM, SCL, SDA to TMP_GND	$-0.3\text{ V to }+4\text{ V}$
Digital Outputs to GND	$-0.3\text{ V to }V_{IO} + 0.3\text{ V}$
Temperature	
Storage Range	$-55^{\circ}\text{C to }+150^{\circ}\text{C}$
Operating Junction Range	$-40^{\circ}\text{C to }+105^{\circ}\text{C}$
Maximum Reflow (Package Body)	260°C

¹ The input pins have clamp diodes connected to the power supply pins. Whenever input signals exceed the power supply rail by 0.3 V, limit the input current to 20 mA or less.

Stresses at or above those listed under Absolute Maximum Ratings may cause permanent damage to the product. This is a stress rating only; functional operation of the product at these or any other conditions above those indicated in the operational section of this specification is not implied. Operation beyond the maximum operating conditions for extended periods may affect product reliability.

THERMAL RESISTANCE

Thermal performance is directly linked to printed circuit board (PCB) design and operating environment. Careful attention to PCB thermal design is required. θ_{JA} is the natural convection junction-to-ambient thermal resistance measured in a one cubic foot sealed enclosure. θ_{JC} is the junction-to-case thermal resistance.

Table 10. Thermal Resistance

Package Type	θ_{JA}	θ_{JC_TOP}	θ_{JC_BOT}	Ψ_{JT}	Unit
BC-178-2	28.96	22.60	14.09	14.03	$^{\circ}\text{C/W}$

ELECTROSTATIC DISCHARGE (ESD) RATINGS

The following ESD information is provided for handling of ESD-sensitive devices in an ESD protected area only.

Human body model (HBM) per ANSI/ESDA/JEDEC JS-001.

Field-induced charged device model (FICDM) per ANSI/ESDA/JEDEC JS-002.

ESD Ratings for ADAQ4224

Table 11. ADAQ4224, 178-Ball CSP_BGA

ESD Model	Withstand Threshold (kV)	Class
HBM	± 4	3A
FICDM	± 1	C3

ESD CAUTION



ESD (electrostatic discharge) sensitive device. Charged devices and circuit boards can discharge without detection. Although this product features patented or proprietary protection circuitry, damage may occur on devices subjected to high energy ESD. Therefore, proper ESD precautions should be taken to avoid performance degradation or loss of functionality.

PIN CONFIGURATIONS AND FUNCTION DESCRIPTIONS

	1	2	3	4	5	6	7	8	9	10	11	12	13	14	15	16	17
A	GND	GND	GND	GND	VDDH	VDDH	GND	GND	GND	GND	GND		TMP_GND	VDD	ALARM		GND
B	GND	GND	GND	GND	GND	GND	GND	GND	GND	GND	GND		RSEL	SCL	SDA		GND
C	INP	GND	VSSH	VSSH	GND	INN	INN	GND	GND	GND	GND						GND
D	INP	GND	GND	GND	GND	GND	GND	GND	GND	GND	REFIN	VDD_5V	GND	GND	CNV	RSTB	VIO
E	GND	GND	A1	A0	GND	VDD_FDA	GND	GND	OUTP	ADCP	GND	VDD_5V	GND	GND	IOGND	IOGND	VIO
F	GND	GND	GND	GND	GND	VDD_FDA	GND	GND	OUTN	ADCN	GND	GND	GND	GND	IOGND	SDO3	SDO1
G	GND	GND	VSSH	VSSH	GND	GND	GND	GND	GND	GND	DNC	DNC	GND	GND	IOGND	SDO2	SDO0
H	GND	GND	GND	GND	GND	GND	GND	PDB_FDA	GND	GND	DNC	DNC	GND	GND	IOGND	IOGND	BUSY_SCKOUT
J	GND	GND	VDDH	VDDH	GND	VSS_FDA	GND	GND	GND	NIC	GND	GND	GND	GND	IOGND	DNC	DNC
K	GND	GND	GND	GND	GND	VSS_FDA	GND	GND	GND	NIC	GND	VDD_1P8V	GND	GND	IOGND	DNC	DNC
L	GND	GND	GND	GND	GND	GND	GND	EN_LDO	GND	GND	GND	VDD_1P8V	GND	CSB	SDI	SCK	IOGND

Figure 12. Pin Configuration

Table 12. Pin Function Descriptions

Pin Number	Mnemonic	Type ¹	Description
A1 to A4, A7 to A11, A17, B1 to B11, B17, C2, C5, C8 to C11, C17, D2 to D10, D13 to D14, E1 to E2, E5, E7 to E8, E11, E13 to E14, F1 to F5, F7 to F8, F11 to F14, G1 to G2, G5 to G6, G8 to G10, G13 to G14, H1 to H6, H8 to H10, H13 to H14, J1 to J2, J5, J7 to J9, J11 to J14, K1 to K5, K7 to K9, K11, K13 to K14, L1 to L6, L9 to L11, L13	GND	P	Power Supply Ground.
A5 to A6, J3 to J4	VDDH	P	PGIA Positive Power Supply. This pin has a 0.1 μ F bypass capacitor inside the package.
A13	TMP_GND	P	Temperature Sensor Ground Return Path.
A14	VDD	P	Temperature Sensor Power Supply. Supply can range from 1.6 V to 3.6 V or connect to VIO for fewer supply rails. This pin has a 0.1 μ F bypass capacitor connected to TMP_GND inside the package.
A15	ALARM	DO	Temperature Sensor Alarm Output. Active when the temperature measured is above the TH or below TL thresholds. Configurable active high/low. It is an open-drain output and requires a pull-up resistor to operate.
B13	RSEL	DI	Connect a resistor between this pin and TMP_GND. Used to uniquely identify up to 32 target devices connected on the same temperature sensor I ² C bus. Connect to TMP_GND if only one device is used.
B14	SCL	DI	Temperature Sensor I ² C Clock.
B15	SDA	DI	Temperature Sensor I ² C Bus Data Line.
C1, D1	INP	AI	Positive Analog Input. Do not leave the INP pin floating. Leaving the INP pin floating can cause the PGIA to draw a larger current from the VDDH and VSSH supply.
C3 to C4, G3 to G4	VSSH	P	PGIA Negative Power Supply. This pin has a 0.1 μ F bypass capacitor inside the package.
C6 to C7	INN	AI	Negative Analog Input. Do not leave the INN pin floating. Leaving the INN pin floating can cause the PGIA to draw a larger current from the VDDH and VSSH supply.

PIN CONFIGURATIONS AND FUNCTION DESCRIPTIONS

Table 12. Pin Function Descriptions (Continued)

Pin Number	Mnemonic	Type ¹	Description
D11	REFIN	AI	Reference Input. Drive REFIN with 4.096 V to 5 V (referred to ground). This pin has the input of the internal reference buffer and has an internal 2 μ F bypass capacitor connected to the output of the buffer.
D12, E12	VDD_5V	P	5 V Power Supply. The range of VDD_5V depends on the reference value, 5.3 V to 5.5 V for a 5 V reference, and 4.75 V to 5.25 V for a 4.096 V reference. This pin has a 1 μ F and 0.1 μ F bypass capacitors inside the package.
D15	CNV	DI	Convert Input. A rising edge on this input powers up the device and initiates a new conversion. This signal must have low jitter to achieve the specified performance of the ADC. Logic levels are determined by the VIO pin.
D16	RSTB	DI	Reset Input (Active Low). Asynchronous ADC reset.
D17, E17	VIO	P	Input/Output Interface Digital Power. Nominally, this pin is at the same supply as the host interface (1.8 V, 1.5 V, or 1.2 V). This pin has a 0.2 μ F bypass capacitor inside the package. For VIO < 1.4 V, Bit IO2X of the output driver register must be set to 1.
E3	A1	DI	PGIA Gain-Control Logic Input 1.
E4	A0	DI	PGIA Gain-Control Logic Input 0.
E6, F6	VDD_FDA	P	FDA Positive Power Supply. This pin has a 0.1 μ F bypass capacitor inside the package. Bypass this pin to GND with at least 2.2 μ F (0402, X5R) ceramic capacitor.
E9	OUTP	AO	Positive FDA Output.
E10	ADCP	AI	Positive ADC Input.
E15 to E16, F15, G15, H15 to H16, J15, K15, L17	IOGND	P	VIO Ground. Connect to the same ground plane as all GND pins.
F9	OUTN	AO	Negative FDA Output.
F10	ADCN	AI	Negative ADC Input.
F16	SDO3	DO	Serial Data Output. The conversion result is output on this pin. It is synchronized to SCK.
F17	SDO1	DO	Serial Data Output. The conversion result is output on this pin. It is synchronized to SCK.
G7, G11 to G12, H11 to H12	DNC		Do Not Connect.
G16	SDO2	DO	Serial Data Output. The conversion result is output on this pin. It is synchronized to SCK.
G17	SDO0	DO	Serial Data Output. The conversion result is output on this pin. It is synchronized to SCK.
H7	PDB_FDA	DI	Power-Down FDA. Active low. Connect the PDB_FDA pin to GND to power down the FDA. Otherwise, connect the PDB_FDA pin to VDD_FDA logic high supply.
H17	BUSY_SCKOUT	DO	BUSY Indicator in SPI Clocking Mode. This pin goes high at the start of a new conversion and returns low when the conversion finishes. Logic levels are determined by the VIO pin. When SCKOUT is enabled, this pin function is either an echo of the incoming SCK from the host controller or a clock sourced by the internal oscillator.
J6, K6	VSS_FDA	P	FDA Negative Supply. This pin has a 0.1 μ F bypass capacitor inside the package. Bypass this pin to GND with at least 2.2 μ F (0402, X5R) ceramic capacitor. Connect to GND for fewer power supply rails.
J10, K10	NIC		Not Internally Connected. These pins are not connected internally.
J16 to J17, K16 to K17	DNC		Do Not Connect. These pins are internally connected to digital output drivers in high-Z mode.
K12, L12	VDD_1.8V	P	LDO Voltage Output. The output is typically at 1.8 V. This pin has a 1 μ F and 0.1 μ F bypass capacitors inside the package.
L7	EN_LDO	DI	Enable LDO pin. For automatic start-up, connect EN_LDO to VLDO.
L8	VLDO	P	Internal LDO Input Supply. This pin has a 1 μ F bypass capacitor inside the package. The input range for VLDO is 2.2 V to 5.5 V.
L14	CSB	DI	Chip Select Input (Active Low).
L15	SDI	DI	Serial Data Input.
L16	SCK	DI	Serial-Data Clock Input. When the device is selected (CSB = low), the conversion result is shifted out by this clock.

¹ AI is analog input, AO is analog output, P is power, DI is digital input, and DO is digital output.

TYPICAL PERFORMANCE CHARACTERISTICS

$V_{DDH} = 18\text{ V}$, $V_{SSH} = -18\text{ V}$, $V_{DD_FDA} = 5.4\text{ V}$, $V_{SS_FDA} = 0\text{ V}$, $V_{DD_5V} = 5.4\text{ V}$, $V_{LDO} = 5.4\text{ V}$, $V_{DD_1.8V} = 1.8\text{ V}$, $V_{IO} = 1.8\text{ V}$, $REFIN = 5\text{ V}$, $f_s = 2\text{ MSPS}$, and all specifications T_{MIN} to T_{MAX} , unless otherwise noted.

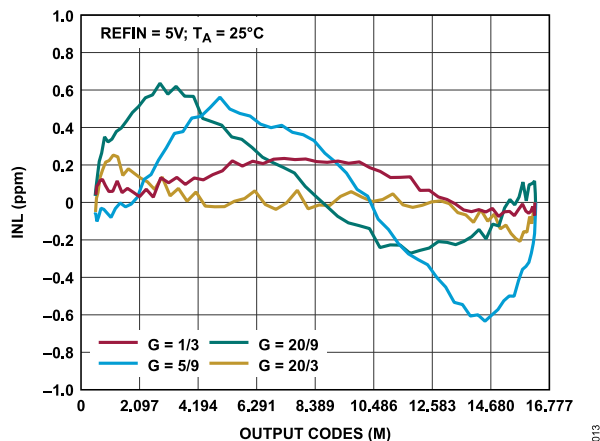

Figure 13. INL Error vs. Output Code, Differential Input, REFIN = 5 V

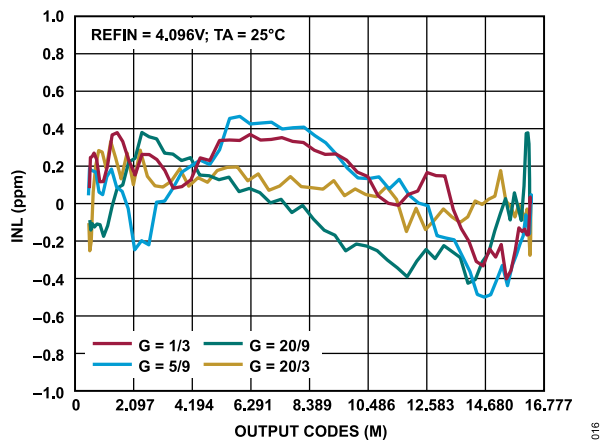

Figure 16. INL Error vs. Output Code, Differential Input, REFIN = 4.096 V

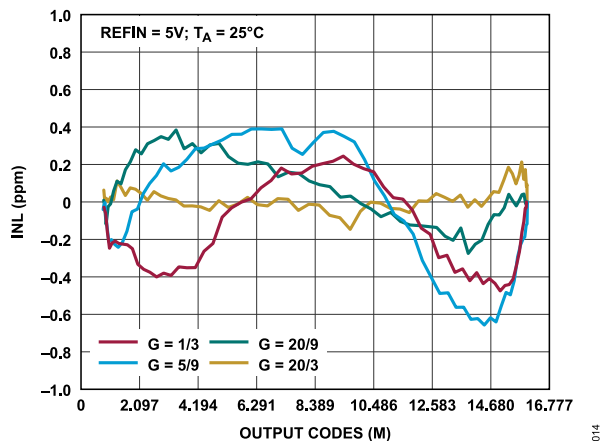

Figure 14. INL Error vs. Output Code, Single-Ended Input, REFIN = 5 V

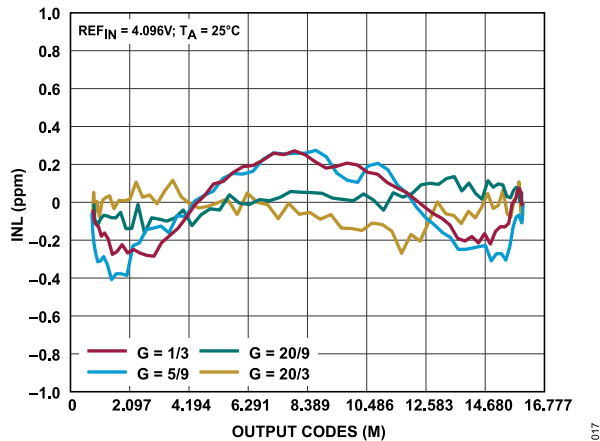

Figure 17. INL Error vs. Output Code, Single-Ended Input, REFIN = 4.096 V

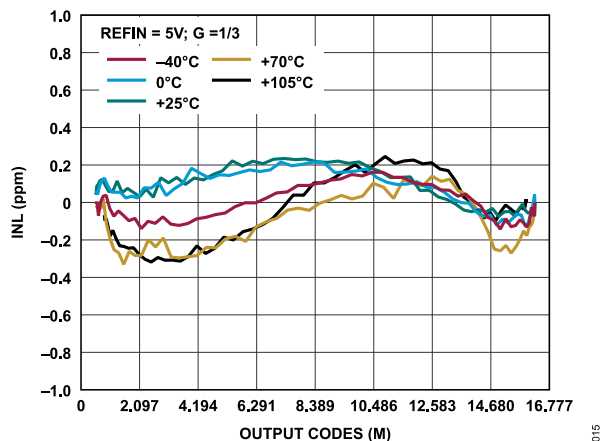

Figure 15. INL Error vs. Output Code across Temperature, G = 1/3

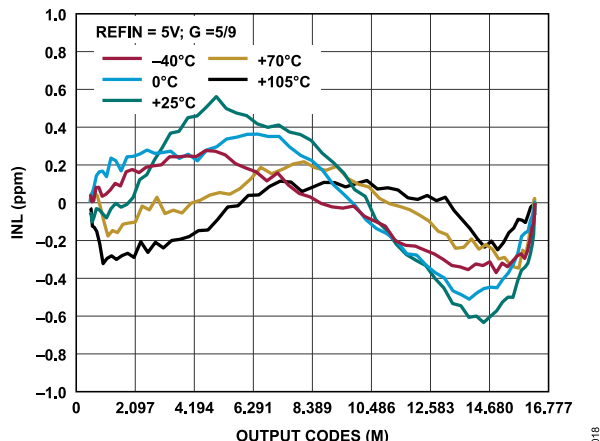

Figure 18. INL Error vs. Output Code across Temperature, G = 5/9

TYPICAL PERFORMANCE CHARACTERISTICS

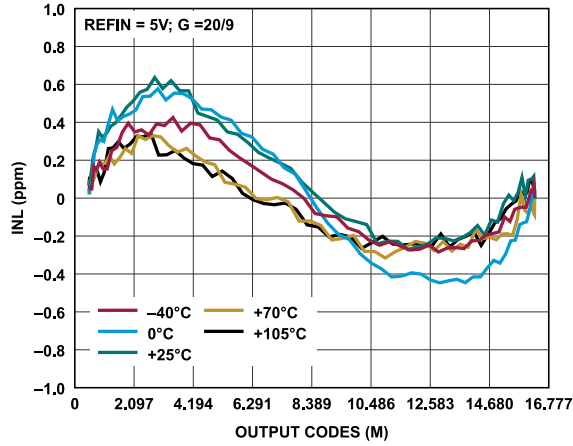

Figure 19. INL Error vs. Output Code across Temperature, G = 20/9

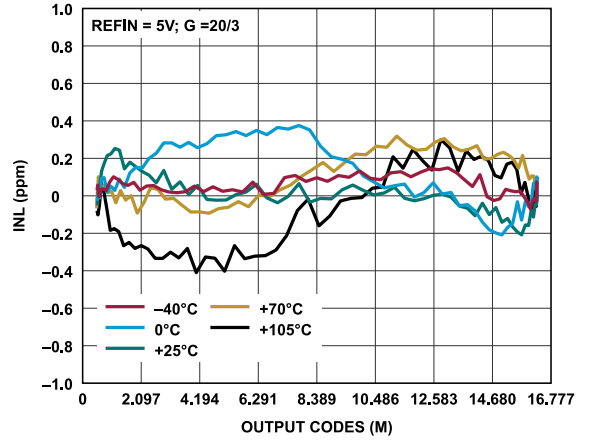

Figure 22. INL Error vs. Output Code across Temperature, G = 20/3

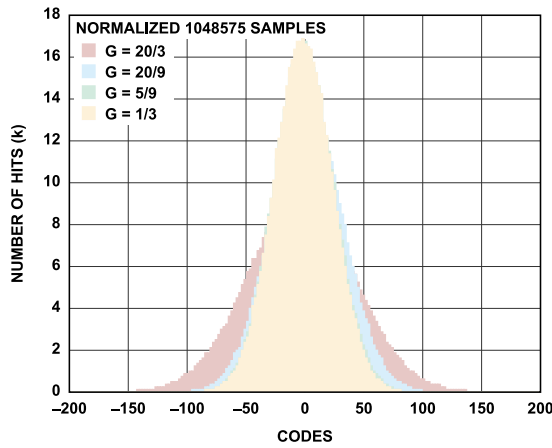

Figure 20. Code Histogram for Shorted Inputs, REFIN = 5 V

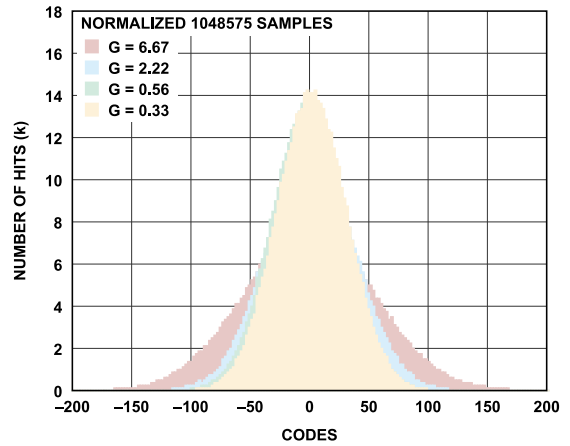

Figure 23. Code Histogram for Shorted Inputs, REFIN = 4.096 V

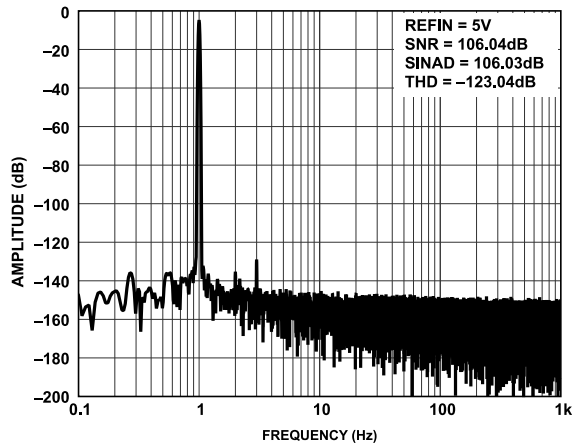

Figure 21. FFT, 2 MSPS, $f_{IN} = 1$ kHz, Differential Input = -0.5 dBFS, G = 1/3

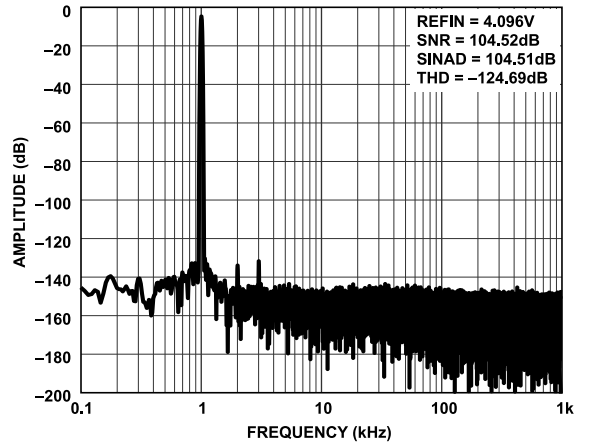

Figure 24. FFT, 2 MSPS, $f_{IN} = 1$ kHz, Differential Input = -0.5 dBFS, G = 1/3

TYPICAL PERFORMANCE CHARACTERISTICS

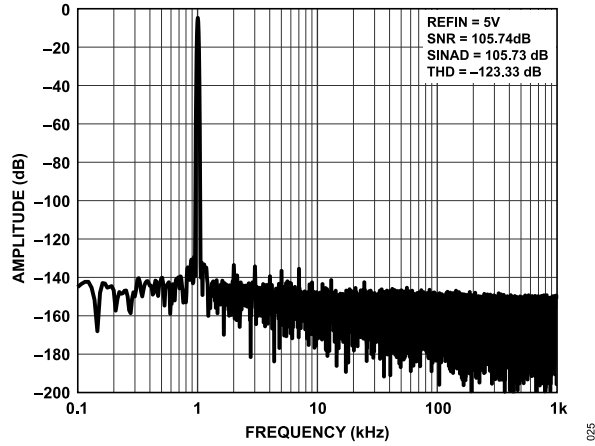

Figure 25. FFT, 2 MSPS, $f_{IN} = 1$ kHz, Differential Input = -0.5 dBFS, G = 5/9

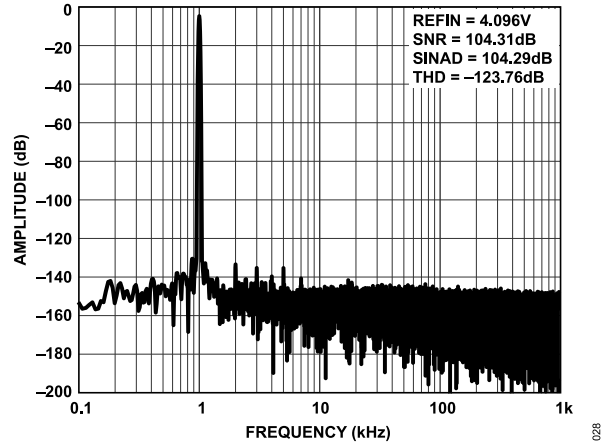

Figure 28. FFT, 2 MSPS, $f_{IN} = 1$ kHz, Differential Input = -0.5 dBFS, G = 5/9

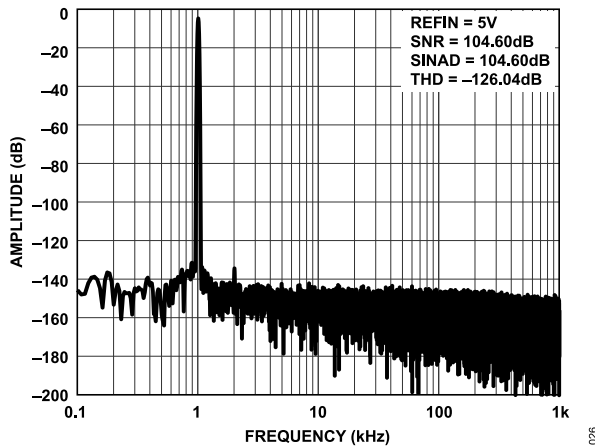

Figure 26. FFT, 2 MSPS, $f_{IN} = 1$ kHz, Differential Input = -0.5 dBFS, G = 20/9

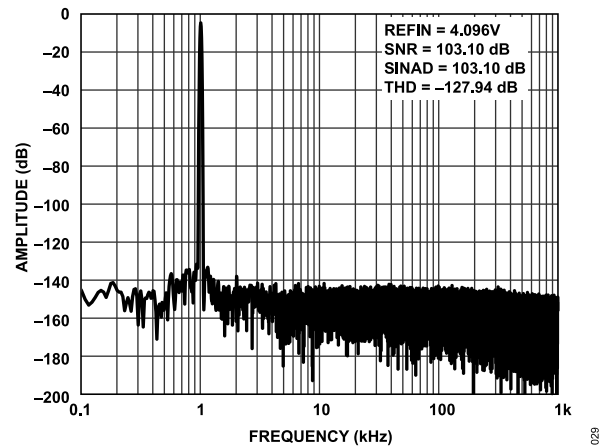

Figure 29. FFT, 2 MSPS, $f_{IN} = 1$ kHz, Differential Input = -0.5 dBFS, G = 20/9

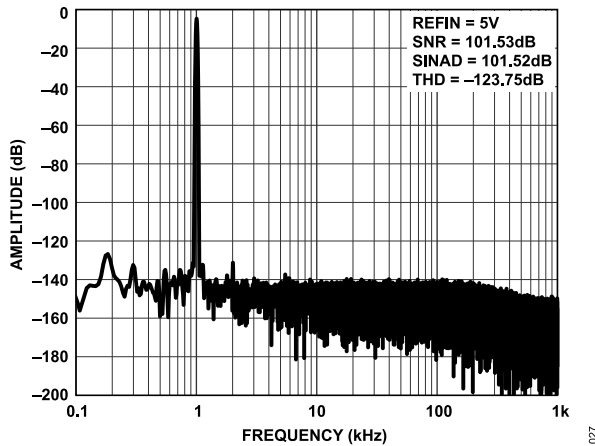

Figure 27. FFT, 2 MSPS, $f_{IN} = 1$ kHz, Differential Input = -0.5 dBFS, G = 20/3

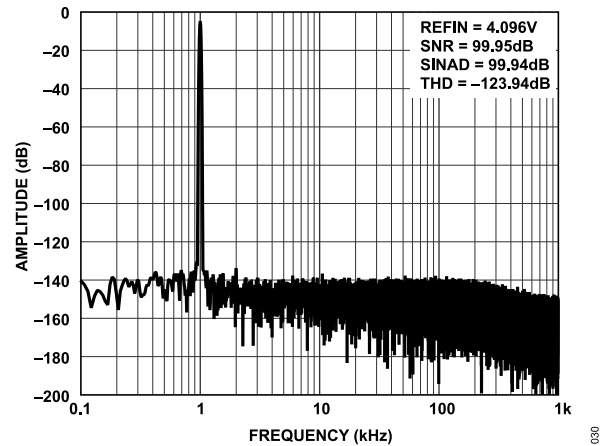

Figure 30. FFT, 2 MSPS, $f_{IN} = 1$ kHz, Differential Input = -0.5 dBFS, G = 20/3

TYPICAL PERFORMANCE CHARACTERISTICS

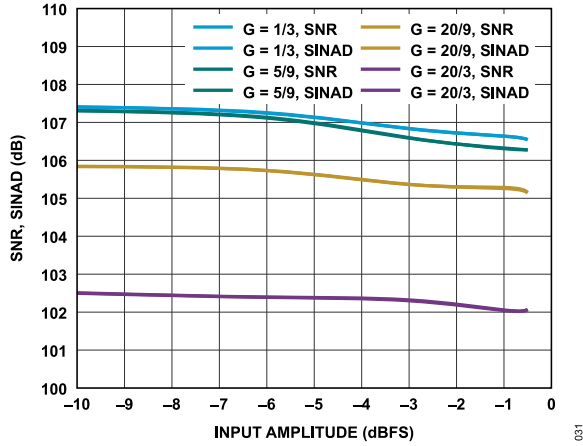

Figure 31. SNR, SINAD vs. Input Amplitude at $f_{IN} = 1$ kHz

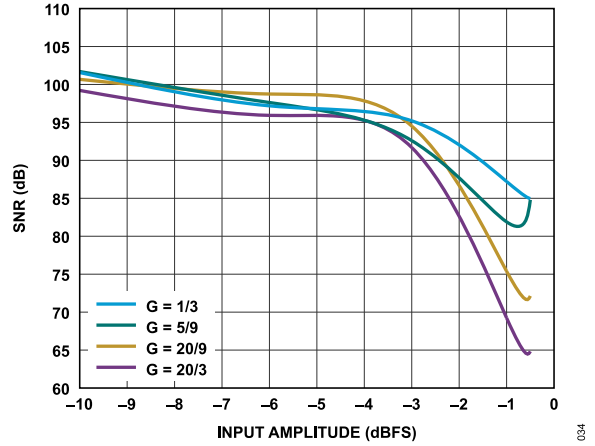

Figure 34. SNR vs. Input Amplitude at $f_{IN} = 50$ kHz

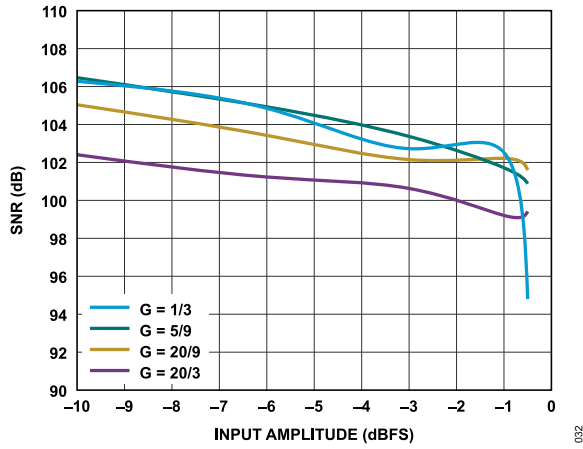

Figure 32. SNR vs. Input Amplitude at $f_{IN} = 20$ kHz

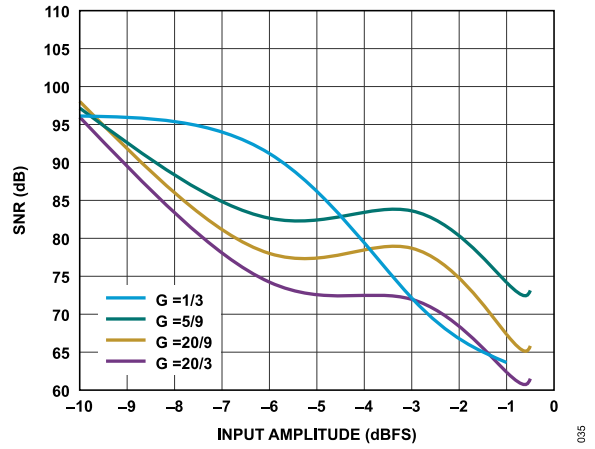

Figure 35. SNR vs. Input Amplitude at $f_{IN} = 100$ kHz

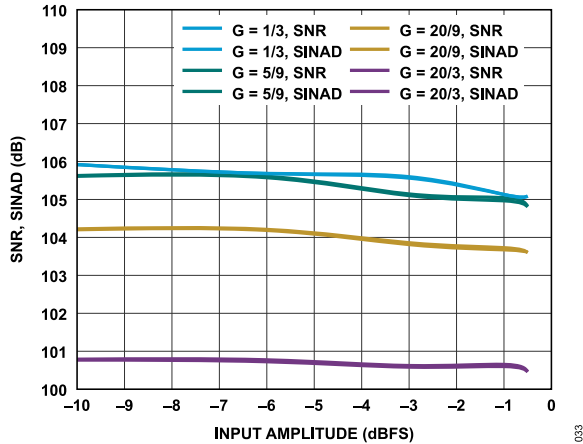

Figure 33. SNR, SINAD vs. Input Amplitude at $f_{IN} = 1$ kHz, $REF_{IN} = 4.096$ V

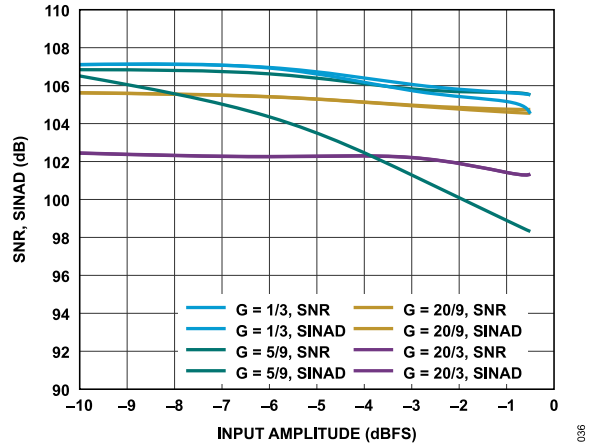

Figure 36. SNR, SINAD vs. Input Amplitude at $f_{IN} = 1$ kHz Single-Ended

TYPICAL PERFORMANCE CHARACTERISTICS

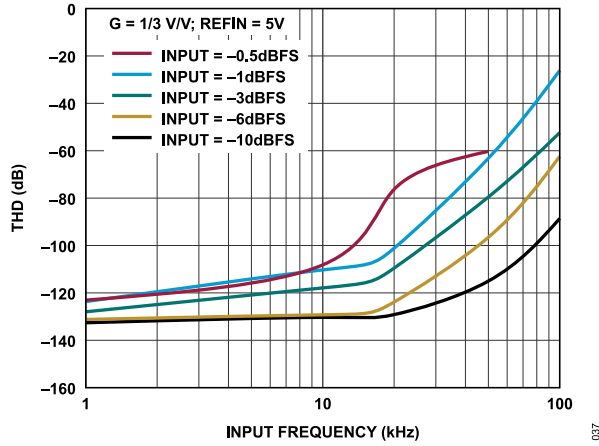

Figure 37. THD vs. Input Frequency, Various Amplitudes, G = 1/3

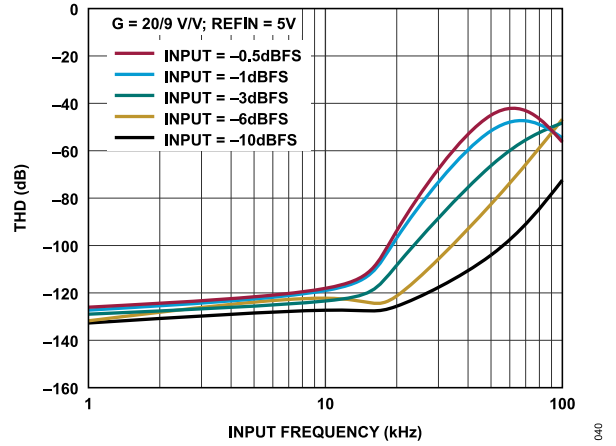

Figure 40. THD vs. Input Frequency, Various Amplitudes, G = 20/9

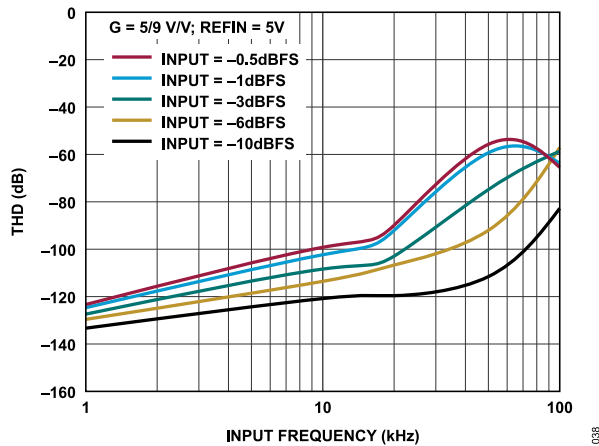

Figure 38. THD vs. Input Frequency, Various Amplitudes, G = 5/9

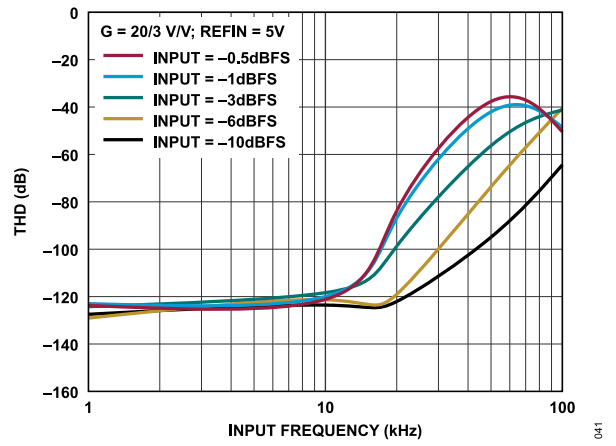

Figure 41. THD vs. Input Frequency, Various Amplitudes, G = 20/3

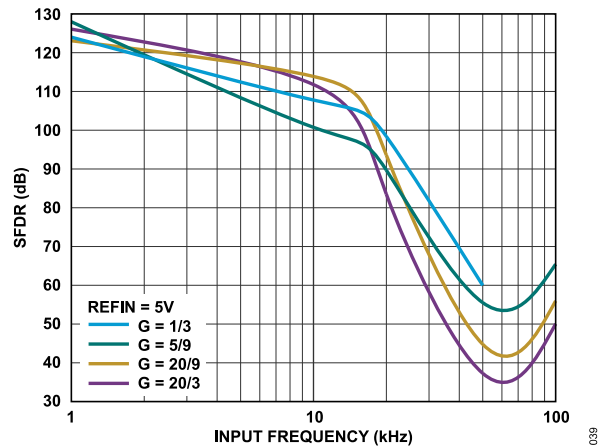

Figure 39. SFDR vs. Input Frequency, -0.5 dBFS, REFIN = 5 V

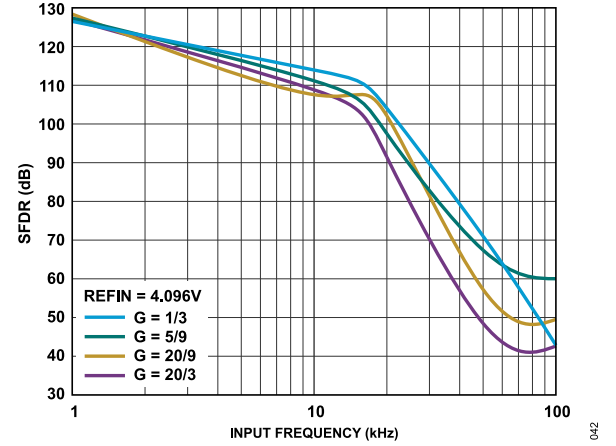

Figure 42. SFDR vs. Input Frequency, -0.5 dBFS, REFIN = 4.096 V

TYPICAL PERFORMANCE CHARACTERISTICS

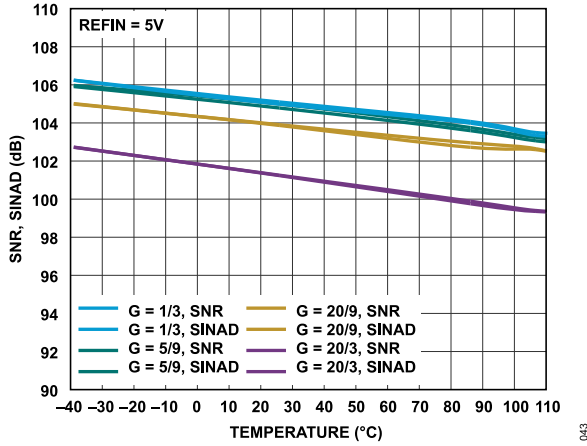

Figure 43. SNR, SINAD vs. Temperature, $f_{IN} = 1$ kHz Differential Input, $REFIN = 5$ V

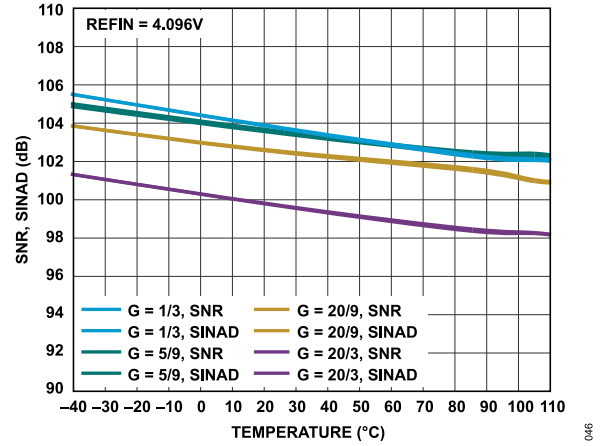

Figure 46. SNR, SINAD vs. Temperature, $f_{IN} = 1$ kHz Differential Input, $REFIN = 4.096$ V

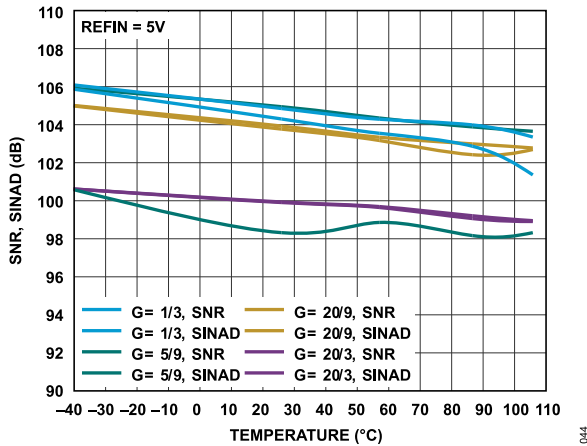

Figure 44. SNR, SINAD vs. Temperature, $f_{IN} = 1$ kHz Single-Ended Input, $REFIN = 5$ V

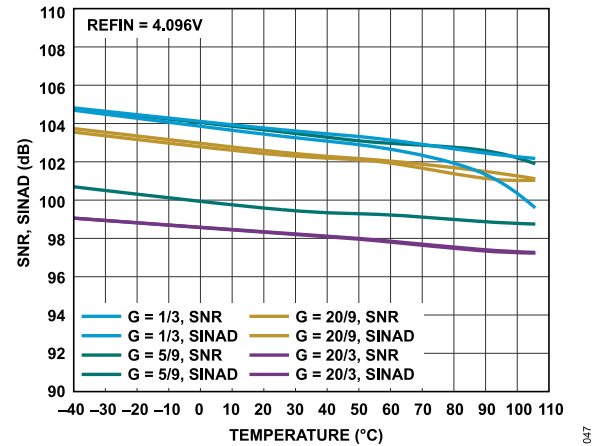

Figure 47. SNR, SINAD vs. Temperature, $f_{IN} = 1$ kHz Single-Ended Input, $REFIN = 4.096$ V

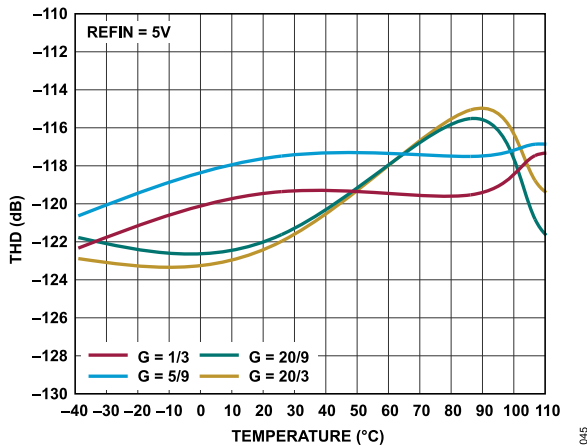

Figure 45. THD vs. Temperature, $f_{IN} = 1$ kHz Differential Input, $REFIN = 5$ V

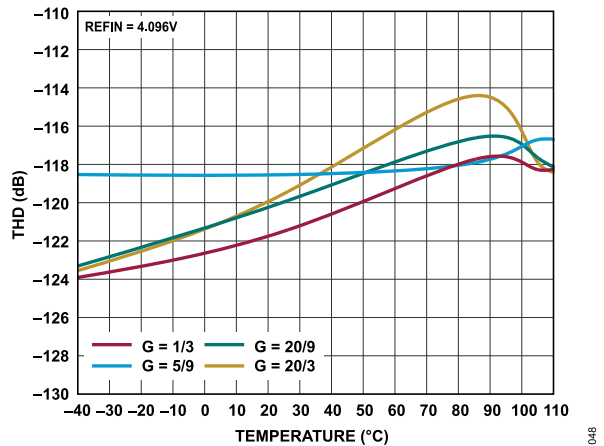

Figure 48. THD vs. Temperature, $f_{IN} = 1$ kHz Differential Input, $REFIN = 4.096$ V

TYPICAL PERFORMANCE CHARACTERISTICS

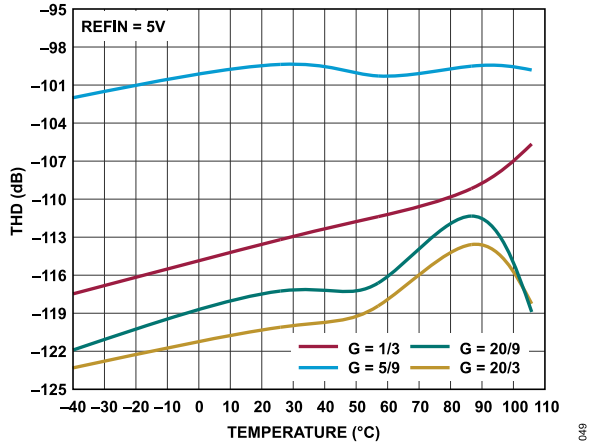

Figure 49. THD vs. Temperature, $f_{IN} = 1$ kHz Single-Ended Input, $REFIN = 5$ V

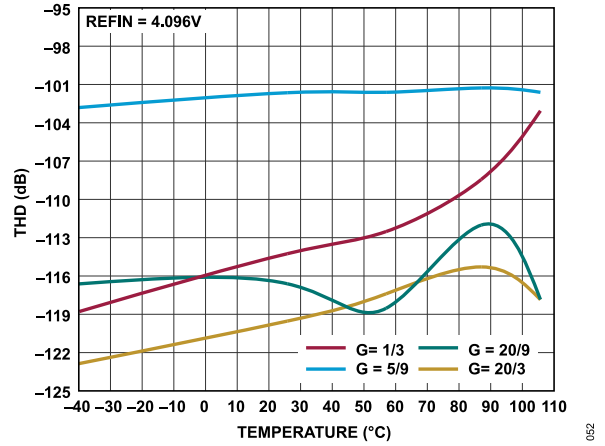

Figure 52. THD vs. Temperature, $f_{IN} = 1$ kHz Single-Ended Input, $REFIN = 4.096$ V

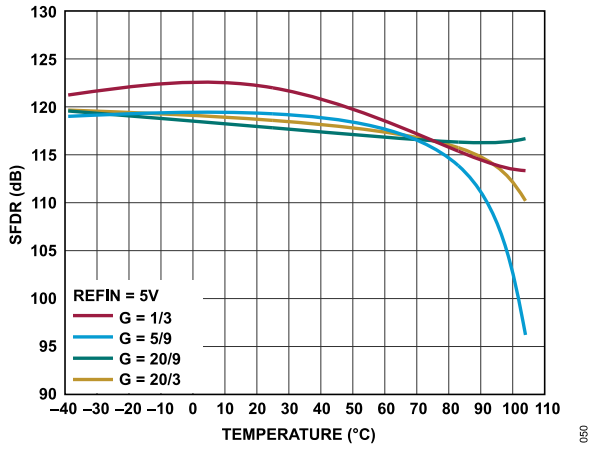

Figure 50. SFDR vs. Temperature, $f_{IN} = 1$ kHz, $REFIN = 5$ V

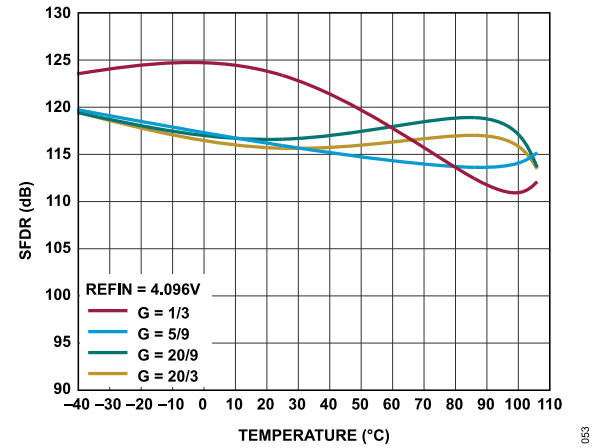

Figure 53. SFDR vs. Temperature, $f_{IN} = 1$ kHz, $REFIN = 4.096$ V

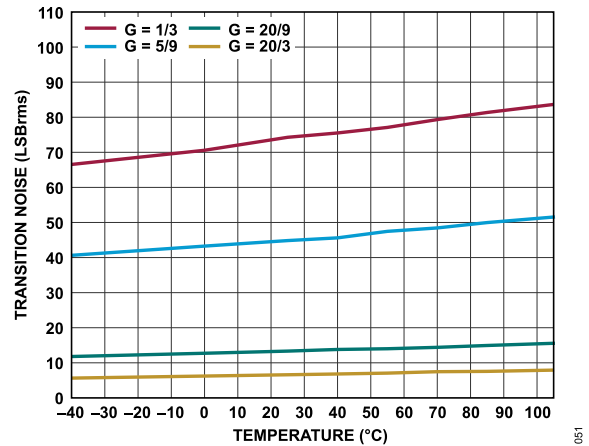

Figure 51. Transition Noise vs. Temperature, $REFIN = 5$ V

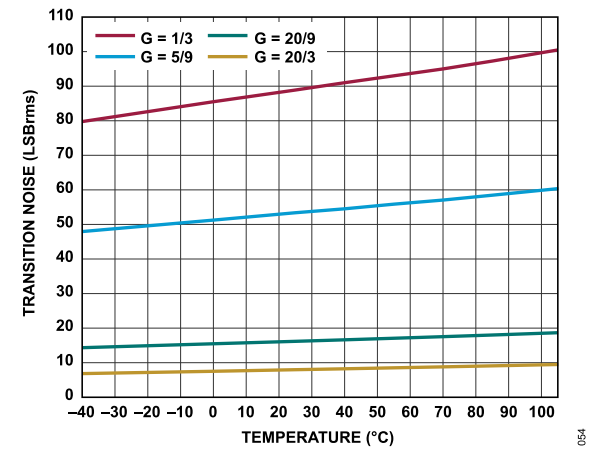

Figure 54. Transition Noise vs. Temperature, $REFIN = 4.096$ V

TYPICAL PERFORMANCE CHARACTERISTICS

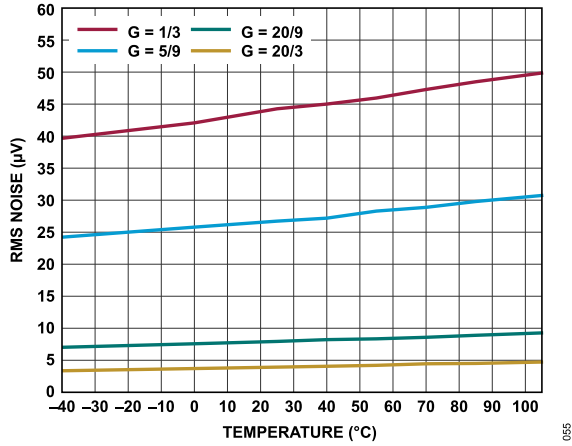

Figure 55. RMS Noise vs. Temperature, REFIN = 5 V

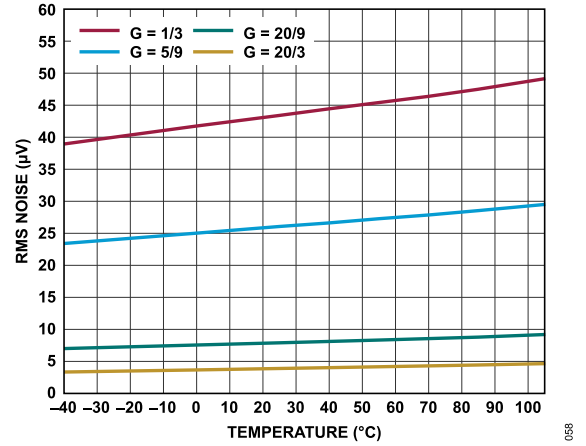

Figure 58. RMS Noise vs. Temperature, REFIN = 4.096 V

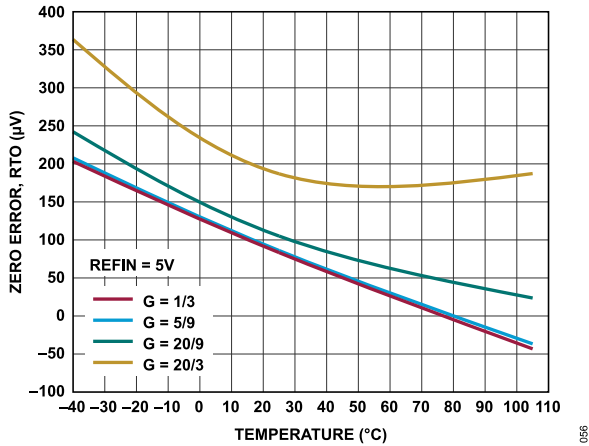

Figure 56. Zero Error vs. Temperature

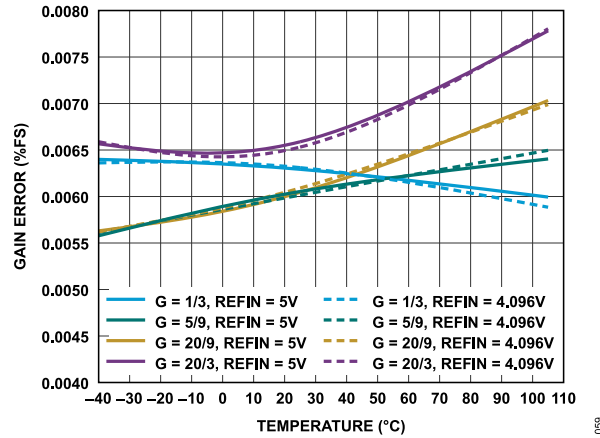

Figure 59. Gain Error vs. Temperature

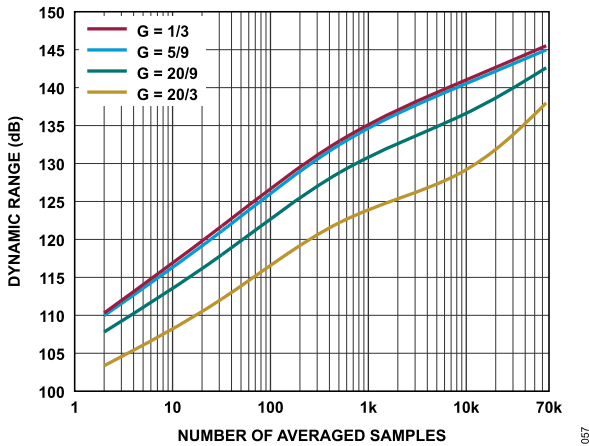

Figure 57. Dynamic Range vs. Number of Averages, Input = -60 dBFS, REFIN = 5 V

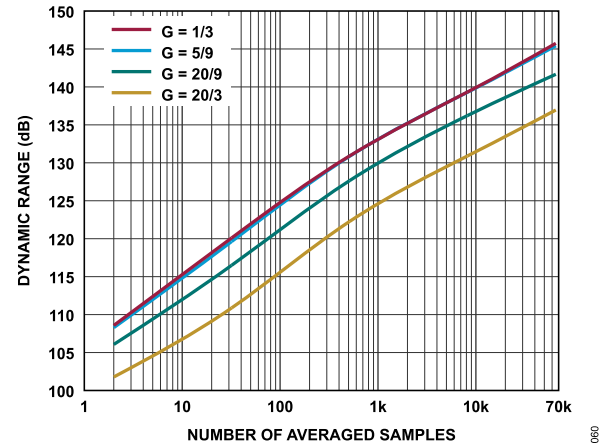

Figure 60. Dynamic Range vs. Number of Averages, Input = -60 dBFS, REFIN = 4.096 V

TYPICAL PERFORMANCE CHARACTERISTICS

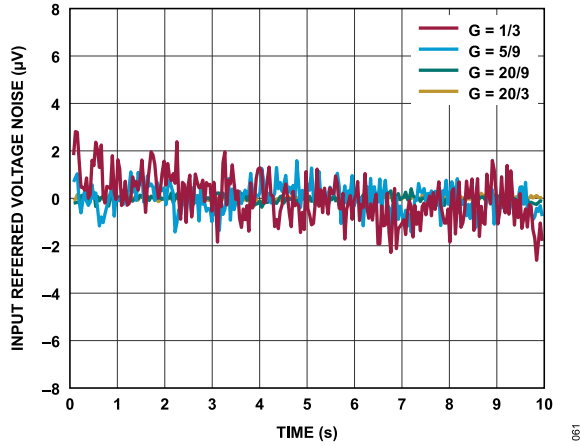

Figure 61. Low Frequency Noise (Output Data Rate = 19.5 SPS After Averaging Blocks of 2048 Samples), REFIN = 5 V

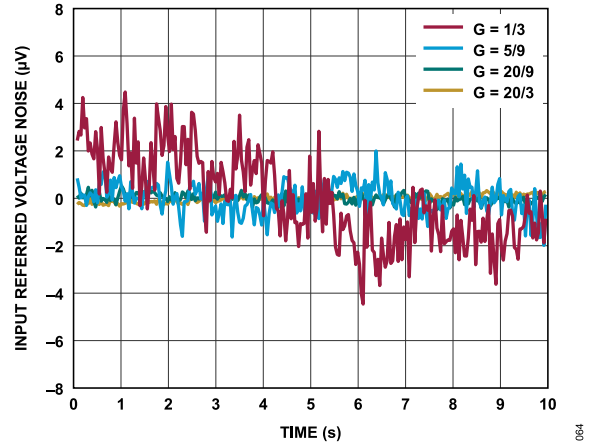

Figure 64. Low Frequency Noise (Output Data Rate = 19.5 SPS After Averaging Blocks of 2048 Samples), REFIN = 4.096 V

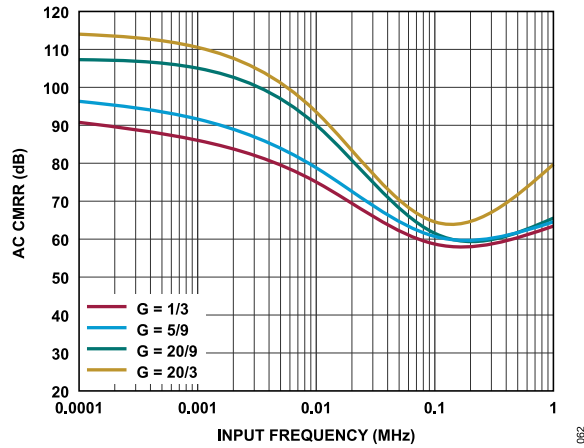

Figure 62. AC CMRR vs. Input Frequency, REFIN = 5 V

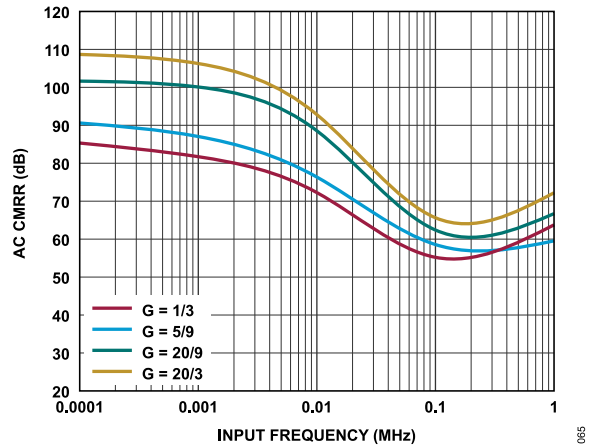

Figure 65. AC CMRR vs. Input Frequency, REFIN = 4.096 V

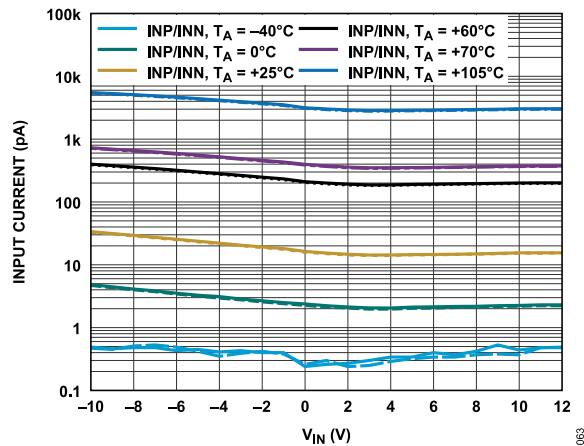

Figure 63. Input Current vs. Input Voltage across Temperature

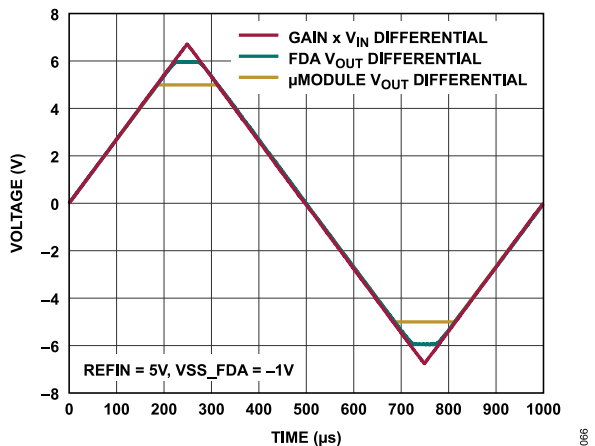

Figure 66. Output Overdrive Recovery, IN = 1 kHz

TYPICAL PERFORMANCE CHARACTERISTICS

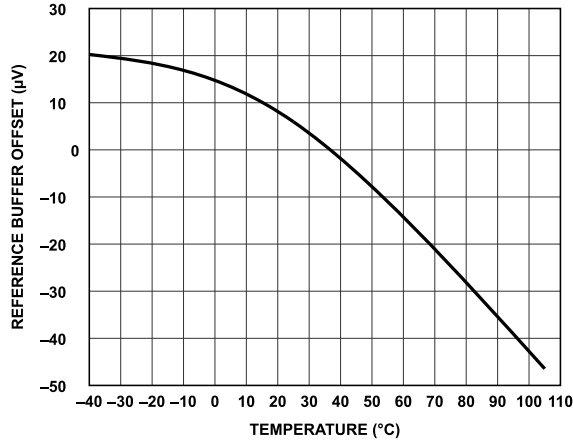

Figure 67. Reference Buffer Offset vs. Temperature

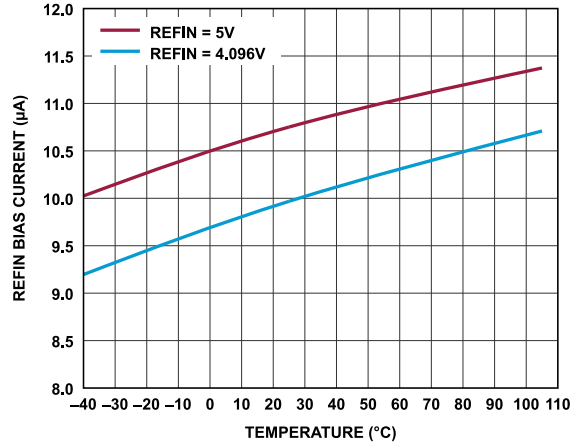

Figure 70. REFIN Current Normal Operation vs. Temperature

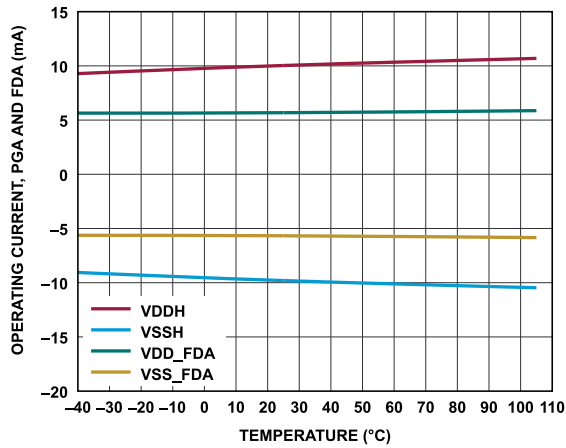

Figure 68. Operating Current PGA and FDA vs. Temperature

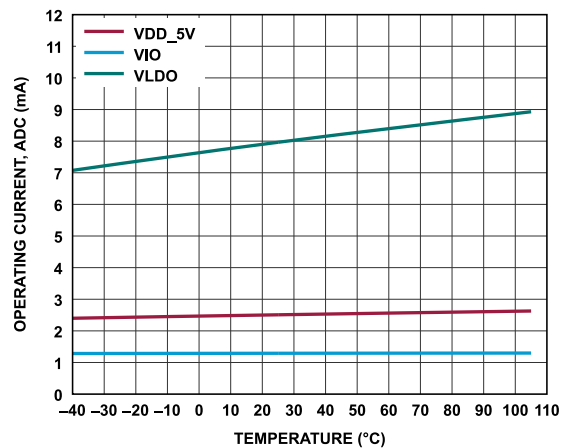

Figure 71. Operating Current ADC vs. Temperature

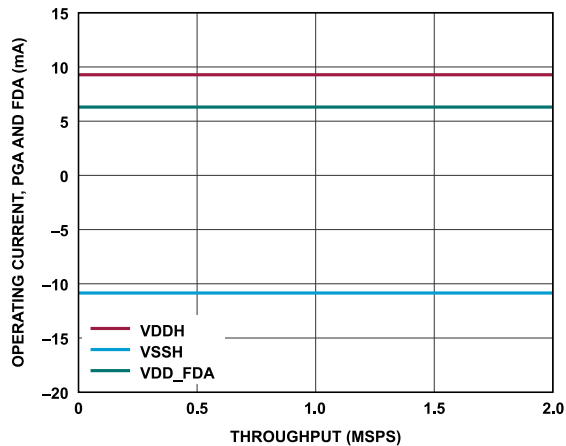

Figure 69. Operating Current PGA and FDA vs. Sample Rate

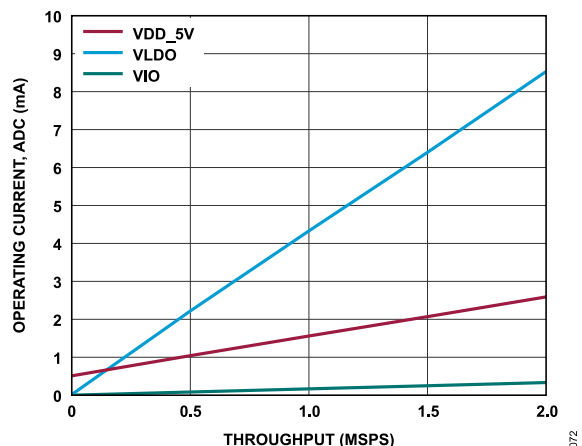

Figure 72. Operating Current ADC vs. Sample Rate

TYPICAL PERFORMANCE CHARACTERISTICS

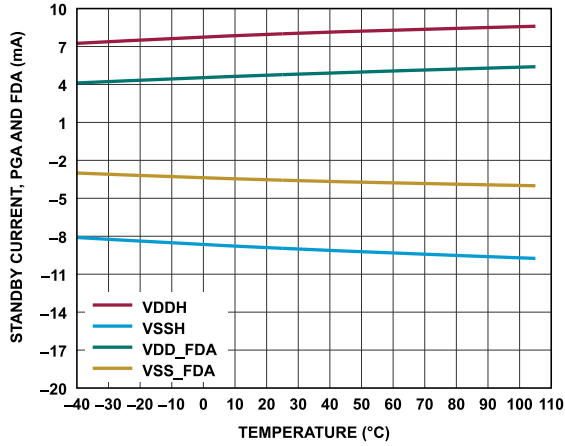

Figure 73. Standby Current PGA and FDA vs. Temperature

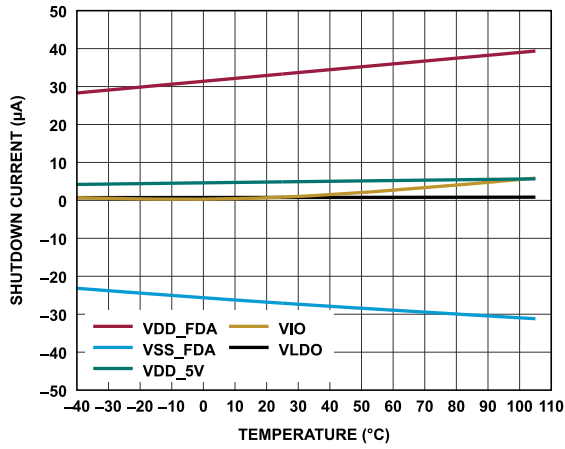

Figure 74. Shutdown Current vs. Temperature

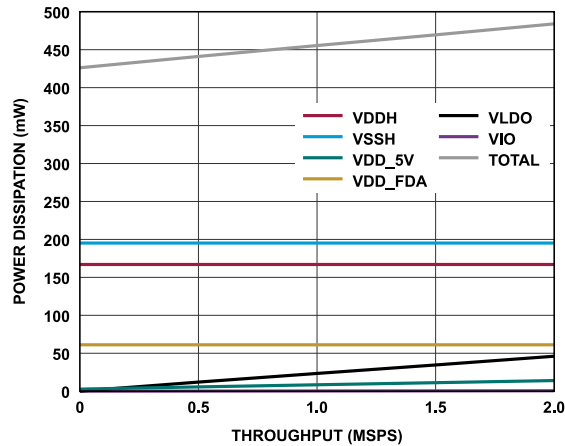

Figure 75. Power Dissipation vs. Throughput

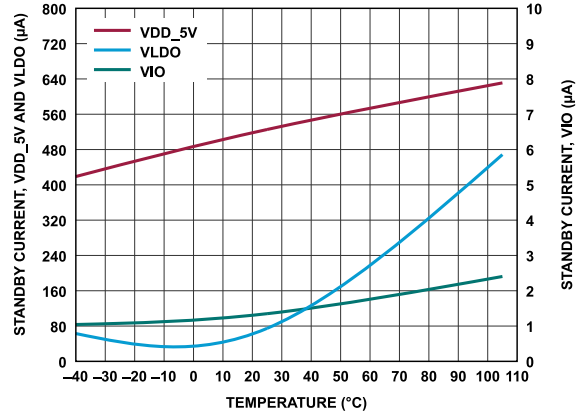

Figure 76. Standby Current ADC vs. Temperature

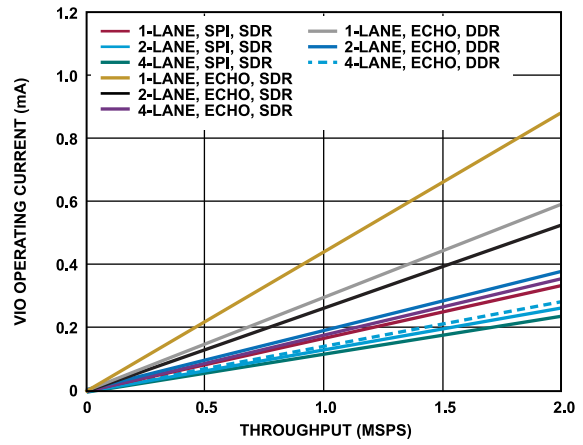

Figure 77. VIO Operating Current vs. Sample Rate

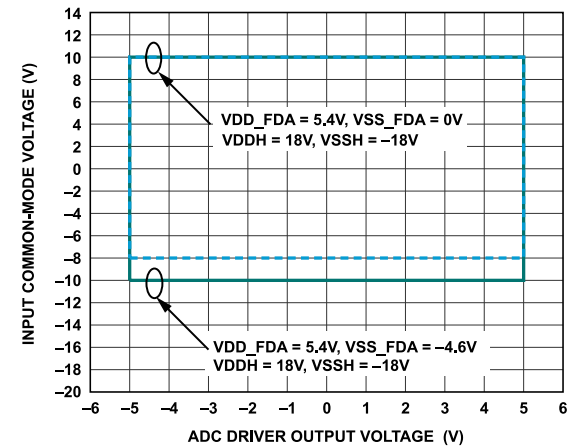

Figure 78. Input Common-Mode Voltage vs. ADC Driver Output Voltage, All Gains

TYPICAL PERFORMANCE CHARACTERISTICS

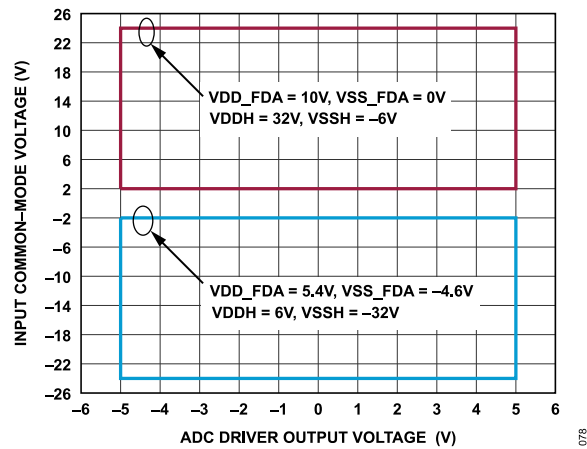

Figure 79. Input Common-Mode Voltage vs. ADC Driver Output Voltage, All Gains

TERMINOLOGY

INTEGRAL NONLINEARITY ERROR (INL)

INL is the deviation of each individual code from a line drawn from negative full scale through positive full scale. The point used as negative full scale occurs $\frac{1}{2}$ LSB before the first code transition. Positive full scale is defined as a level $1\frac{1}{2}$ LSB beyond the last code transition. The deviation is measured from the middle of each code to the true straight line (see [Figure 81](#)).

DIFFERENTIAL NONLINEARITY ERROR (DNL)

In an ideal ADC, code transitions are 1 LSB apart. DNL is the maximum deviation from this ideal value. It is often specified in terms of resolution for which no missing codes are guaranteed.

OFFSET ERROR

Offset error is the difference between the ideal midscale voltage, 0 V, and the actual voltage producing the midscale output code, 0 LSB.

GAIN ERROR

The first transition (from 100 ... 00 to 100 ... 01) occurs at a level $\frac{1}{2}$ LSB above nominal negative full scale. The last transition (from 011 ... 10 to 011 ... 11) occurs for an analog voltage $1\frac{1}{2}$ LSB below the nominal full scale. The gain error is the deviation of the difference between the actual level of the last transition and the actual level of the first transition from the difference between the ideal levels.

SPURIOUS-FREE DYNAMIC RANGE (SFDR)

SFDR is the difference, in decibels (dB), between the rms amplitude of a full-scale input signal and the peak spurious signal.

EFFECTIVE NUMBER OF BITS (ENOB)

ENOB is a measurement of the resolution with a sine wave input. It is related to SINAD as follows: $ENOB = (SINAD_{dB} - 1.76)/6.02$. ENOB is expressed in bits.

TOTAL HARMONIC DISTORTION (THD)

THD is the ratio of the rms sum of the first five harmonic components to the rms value of a full-scale input signal and is expressed in decibels.

DYNAMIC RANGE

Dynamic range is the rms voltage of a full-scale sine wave to the total rms voltage of the noise measured. The value for dynamic range is expressed in decibels. It is measured with a signal at -60 dBFS so that it includes all noise sources and DNL artifacts.

TOTAL SYSTEM DYNAMIC RANGE

The ratio of the root-mean-square (RMS) value of the full scale input at Gain = $1/3$ V/V to the input referred RMS noise measured when input pins are shorted together at Gain = $20/3$ V/V. The value is expressed in decibels.

SIGNAL-TO-NOISE RATIO (SNR)

SNR is the ratio of the rms voltage of a full-scale sine wave to the rms sum of all other spectral components below the Nyquist frequency, excluding harmonics and DC. The value for SNR is expressed in decibels.

SIGNAL-TO-NOISE-AND-DISTORTION (SINAD) RATIO

SINAD is the ratio of the rms voltage of a full-scale sine wave to the rms sum of all other spectral components that are less than the Nyquist frequency, including harmonics but excluding DC. The value of SINAD is expressed in decibels.

APERTURE DELAY

Aperture delay is the measure of the acquisition performance and is the time between the rising edge of the CNV input and when the input signal is held for a conversion.

TRANSIENT RESPONSE

Transient response is the time required for the ADC to acquire a full-scale input step to ± 1 LSB accuracy.

COMMON-MODE REJECTION RATIO (CMRR)

CMRR is the ratio of the power in the ADC output at the frequency, f , to the power of a 4.5 V p-p sine wave applied to the input common-mode voltage of frequency, f .

$$CMRR \text{ (dB)} = 10 \times \log(P_{ADC_IN}/P_{ADC_OUT})$$

where:

P_{ADC_IN} is the common-mode power at the frequency, f , applied to the inputs.

P_{ADC_OUT} is the power at the frequency, f , in the ADC output.

POWER-SUPPLY REJECTION RATIO (PSRR)

PSRR is the ratio of the power in the ADC output at the frequency, f , to the power of a 200 mV p-p sine wave applied to the ADC VDD supply of frequency, f .

$$PSRR \text{ (dB)} = 10 \times \log(P_{VDD_IN}/P_{ADC_OUT})$$

where:

P_{VDD_IN} is the power at the frequency, f , at the VDD pin.

P_{ADC_OUT} is the power at the frequency, f , in the ADC output.

THEORY OF OPERATION

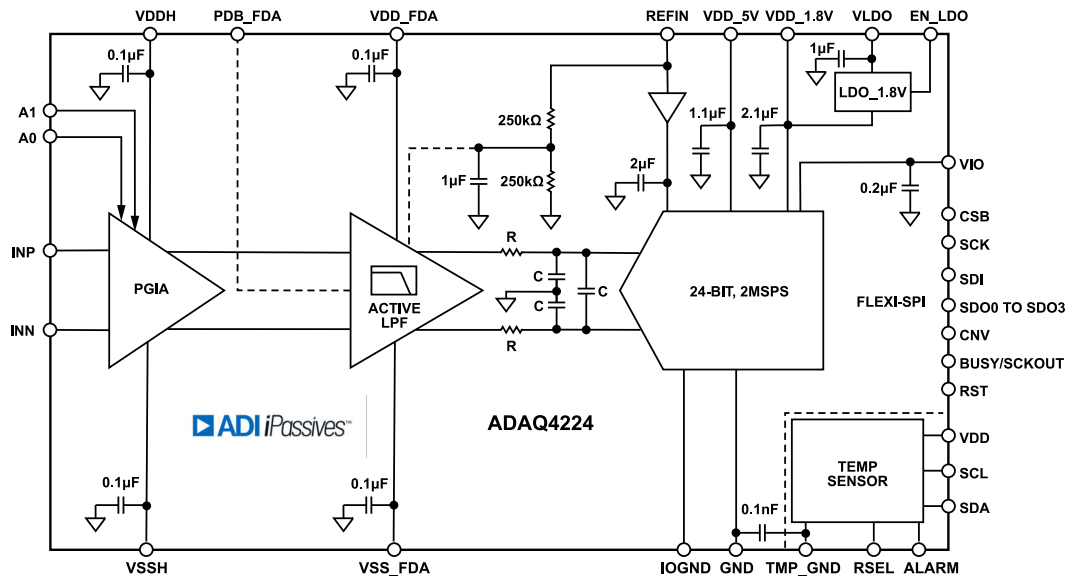

Figure 80. ADAQ4224 Functional Block Diagram

OVERVIEW

The ADAQ4224 is a precision μ Module data-acquisition signal chain SiP solution that reduces the development cycle of precision measurement systems by transferring the design burden of component selection, optimization, and layout from the designer to the device. The ADAQ4224 reduces the end system component count by combining multiple common signal processing and conditioning blocks in a single device, including a low noise, high input impedance PGIA, a second order linear phase anti-aliasing filter, low distortion, wide-bandwidth ADC driver, a high precision 24-bit, 2MSPS SAR ADC with an integrated reference buffer, and a fully-electrically isolated temperature sensor. The device also incorporates the Analog Devices proprietary *i*Passives technology components necessary for optimum performance. The superior matching and drift characteristics of the resistors minimizes the temperature dependent error sources. The analog front end of the ADAQ4224 features a wide common-mode range of -8 V to +10 V and supports both single-ended and differential signals that eases level shifting requirements as well.

The ADAQ4224 does not exhibit any pipeline delay or latency, which makes this μ Module ideal for control loops and high speed applications. The digital features include offset correction, gain adjustment, and averaging, which offload the host processor. The user can configure the device for one of several output code formats (for more details, see the [Summary of Selectable Output Data Formats](#) section).

The ADAQ4224 uses a Flexi-SPI, which allows the data to be accessed by multiple SPI lanes, which relaxes clocking requirements for the host SPI controller. An echo clock mode is also available to assist in data clocking, which simplifies the use of isolated data interfaces. The PGIA gain of the ADAQ4224 can be controlled through A0 and A1 pins. The ADAQ4224 includes an electrically

isolated temperature sensor, which has a 1.8 V, I^2C compatible interface. The leakage current between the temperature sensor ground (TMP_GND) and ADC ground (GND) is 1 nA with ± 250 V across the ground planes. The ADAQ4224 has a valid first conversion after exiting power-down mode. The architecture achieves ± 1 ppm INL maximum, with no missing codes at 24-bits and 106.5 dB SNR. The ADAQ4224 dissipates only 446 mW at 2 MSPS.

TRANSFER FUNCTION

In the default configuration, the ADAQ4224 digitizes the full-scale difference voltage of $2 \times V_{REFIN}$ into 2^{24} levels, which results in an LSB size of $0.596 \mu\text{V}$ with $V_{REFIN} = 5$ V. Note that 1 LSB at 24 bits is approximately 0.06 ppm. The ideal transfer function is shown in [Figure 81](#). The differential output data is in twos complement format. [Table 13](#) summarizes the mapping of input voltages to differential output codes.

THEORY OF OPERATION

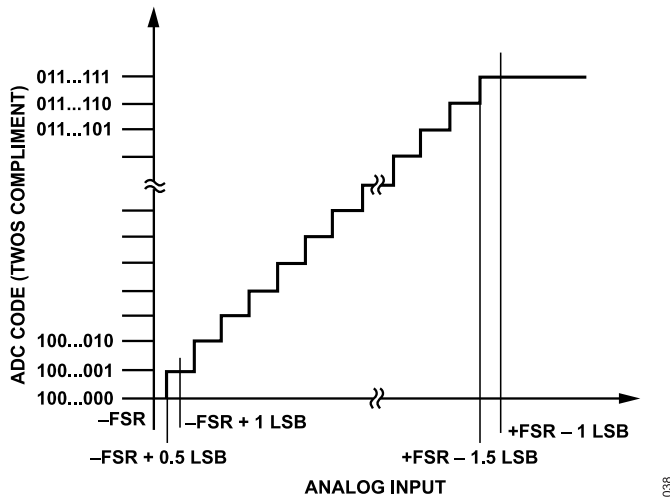

Figure 81. ADC Ideal Transfer Function for the Differential Output Codes (FSR Is Full-Scale Range)

Table 13. Input Voltage to Output Code Mapping

Description	Analog Input Voltage Difference	Digital Output Code (Twos Complement, Hex)
FSR - 1LSB	$(8388607 \times V_{REF}) / (G \times 8388608)$	0x7FFFFF
Midscale + 1LSB	$V_{REF} / (G \times 8388608)$	0x000001
Midscale	0 V	0x000000
Midscale - 1LSB	$-V_{REF} / (G \times 8388608)$	0xFFFFF
-FSR + 1LSB	$-(8388607 \times V_{REF}) / (G \times 8388608)$	0x800001
-FSR	$-V_{REF} / G$	0x800000

SIGNAL CHAIN OPERATION

The ADAQ4224 operates in two phases, the acquisition and the conversion phase. In the acquisition phase, the voltage present on each input pin (INP and INN) of PGIA is sampled independently. Issuing a rising edge pulse on the CNV pin initiates a conversion. The rising edge pulse on the CNV pin also asserts the BUSY signal to indicate a conversion in progress. At the end of the conversion, the BUSY signal is deasserted. The conversion result is a 24-bit code representing the input voltage difference and an 8-bit code representing the input common-mode voltage. Depending on the device configuration, this conversion result can be processed digitally and latched into the internal output register. The internal ADC acquisition circuit on each input pin is also precharged to the previous sample voltage, which minimizes the kick-back charge to the input driver stage (PGIA). The host processor retrieves the output code by the SDO pins that are internally connected to the internal output register.

DIGITAL SAMPLE PROCESSING FEATURES

The ADAQ4224 supports several digital and data processing features that can be applied to the signal samples. These features are enabled and disabled by the control registers of the ADAQ4224.

Full-Scale Saturation

The conversion results saturate digitally (before any post-processing) when either or both inputs exceed the analog limits specified herein. After applying offset and gain scaling, the results are reduced to 24-bit representation (saturating at maximum 0x7FFFFF and minimum 0x800000). A user must avoid unintentional saturation, especially, when applying digital offset and/or gain scaling. For more details on the use of these features, see the [Digital Offset Adjust](#) and [Digital Gain](#) sections.

Common-Mode Output

When the host controller writes 0x1 or 0x2 to the OUT_DATA_MD bit field of the modes register (for more details, see the [Modes Register](#) section), an 8-bit code representing the input common-mode voltage is appended to the 16-bit or 24-bit code representing the input voltage difference. The LSB size of the 8-bit code is $V_{REF}/256$. The 8-bit code saturates at 0 and 255 when the common-mode input voltage is 0 V and V_{REF} , respectively. The 8-bit code is not affected by digital offset and gain scaling, which is applied only to the code representing the input voltage difference.

Block Averaging

The ADAQ4224 provides a block averaging filter (SINC1) with programmable block length 2^N , $N = 1, 2, 3, \dots, 16$. The filter is reset after processing each block of 2^N samples. The filter is enabled by writing 0x3 to the OUT_DATA_MD bit field of the modes register (for more details, see the [Modes Register](#) section) as well as a value ($1 \leq N \leq 16$) to the AVG_VAL bit field in the averaging mode register (for more details, see the [Averaging Mode Register](#) section). In this configuration, the output sample word is 32 bits. The 30 most significant bits (MSBs) represent the numerical value of the 24-bit codes averaged in blocks of 2^N samples. The automatic scaling allows the 24 MSBs of the 30-bit code to be equal to the 24-bit codes when averaging blocks of constant values. The 31st bit (OR) is an overrange warning bit that is high when one or more samples in the block are subject to saturation. The 32nd bit (SYNC) is high once every 2^N conversion cycles to indicate when the average values are updated at the end of each block of samples. For more details, see the [Digital Sample Processing Features](#) section.

The effective data rate in averaging mode is $f_{CNV}/2^N$. The reset value of N in the AVG_VAL bit field is 0x00 (no averaging). [Figure 105](#) shows an example timing diagram in averaging mode. [Figure 82](#) shows the frequency response of the filter for an $N = 1, 2, 3, 4, 5$.

THEORY OF OPERATION

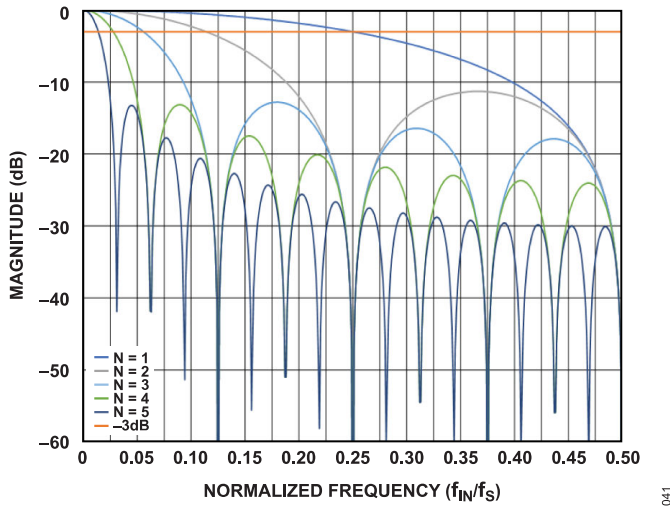

Figure 82. Frequency Response Examples for the Block Averaging Filter

Digital Offset Adjust

The ADC can be programmed to add a 24-bit signed offset value to the sample data (for more details, see the Register Details section). When adding an offset to the samples, it is possible to cause the sample data to saturate numerically. The user must take this into account when using the offset feature. The default value is 0x000000. For more details, see the Offset Registers section.

Digital Gain

The ADC can be programmed to apply a 16-bit unsigned digital gain (Register 0x1C and Register 0x1D) to the digital samples (for more details, see the Register Details section). The gain is applied to each sample based on the following equation:

$$Code_{OUT} = Code_{IN} \times (USER_GAIN / 0 \times 8000) \quad (1)$$

where:

$$0x0000 \leq USER_GAIN \leq 0xFFFF.$$

The effective gain range is 0 to 1.99997. Note that applying gain to the samples may cause numerical saturation. The default value is 0x8000 (gain = 1). To measure input voltage differences exceeding $\pm V_{REF}$, set the gain less than the unity to avoid the numerical saturation of the 24-bit, 16-bit, or 30-bit output differential codes. For more details, see the Gain Registers section.

Test Pattern

To facilitate functional testing and debugging of the SPI, the host controller can write a 32-bit test pattern to the ADAQ4224 (for more details, see the Test Pattern Registers section). The value written to the test pattern registers is output using the normal sample cycle timing. The 32-bit test pattern output mode is enabled by writing 0x4 to the OUT_DATA_MD bit field of the modes register (for more details, see the Modes Register section). The default value stored in the test pattern registers is 0x5A5A0F0F.

Summary of Selectable Output Data Formats

Figure 83 summarizes the output data formats that are available on the ADAQ4224, which are selected in the modes register (for more details, see the Modes Register section). Note that the OR and SYNC flags are each 1-bit.

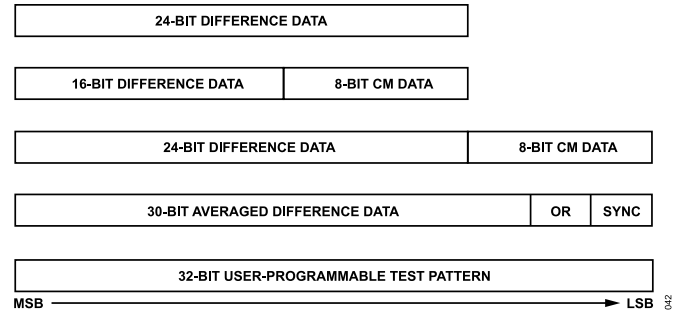

Figure 83. Summary of Selectable Output Sample Formats

TEMPERATURE SENSOR OPERATION

The ADAQ4224 includes a temperature sensor that is electrically isolated from the data-acquisition signal path within the μ Module. In applications, where the ADAQ4224 is isolated, the ground of the data-acquisition signal path can float to any voltage level (for example, 200 V) while the temperature sensor stays at ground and its digital input/output pins do not need to be isolated. The temperature sensor enables predictable drift measurement of complete data-acquisition signal path and simplifies system-level calibration of the signal path vs. temperature change. The 1.8 V, I²C-compatible serial interface accepts standard write and read commands to read the temperature data and configure the behavior of the sensor. It offers 12-bit temperature measurements with excellent accuracy of $\pm 1^\circ\text{C}$ maximum from -40°C to $+105^\circ\text{C}$. Multiple register settings allow a host to configure the temperature sensor for automatic temperature measurements, change the ALARM thresholds and hysteresis, and configure the polarity of the ALARM output. The temperature sensor includes an RSEL address pin, which can be connected to an external resistor to uniquely identify up to 32 devices connected on the same I²C bus.

The temperature sensor provides 12-bit temperature measurements and asserts the ALARM output when the measured temperature is outside of the programmed range defined by the low and high temperature registers, TL and TH, respectively. The temperature data is also available to read by a host microcontroller using the I²C bus. Multiple register settings allow a host to configure the part for automatic temperature measurements, change ALARM thresholds and hysteresis, and configure the polarity of the ALARM output.

Measuring Temperature

A resolution of 8-, 9-, 10-, or 12-bits can be selected using the configuration register. 8-bit resolution corresponds to a least significant bit (LSB) value of $+1^\circ\text{C}$, while 12-bit resolution corresponds

THEORY OF OPERATION

to an LSB value of +0.0625°C. The sensor powers up in a preconfigured state. For the default/power-up settings, see the [Device Configuration Register](#) section.

Temperature Sensor Device Address

The temperature sensor employs an I²C 7-bit addressing scheme. An external resistor connected to the RSEL pin is measured upon power up of the VDD pin. The value of the resistor defines the device address and the value can be used to identify up to 32 devices connected to the same I²C bus. Mapping the address selection resistor value to Bits[A4:A0] is shown in [Table 14](#). Connect the RSEL pin to TMP_GND if only one device is used.

The upper two bits are fixed to the values 10. For example, a device that uses a value of 905 kΩ responds to the target address 100000.

Table 14. RSEL Resistor Selection of Device Address Bits[A4:A0]

Bits [A4:A0]	1% Resistor Value (kΩ)	Bits [A4:A0]	1% Resistor Value (kΩ)
11111	4.2	01111	67.3
11110	5	01110	80
11101	5.9	01101	95.1
11100	7.1	01100	113.1
11011	8.4	01011	134.5
11010	10	01010	160
11001	11.9	01001	190.3
11000	14.1	01000	226.3
10111	16.8	00111	269.1
10110	20	00110	320
10101	23.8	00101	380.5

Table 16. Temperature Data Format (S = Sign Bit)

Most Significant Byte (°C)								Least Significant Byte (°C)							
D7	D6	D5	D4	D3	D2	D1	D0	D7	D6	D5	D4	D3	D2	D1	D0
S	S	S	S	128	64	32	16	8	4	2	1	0.5	0.25	0.125	0.0625

Table 14. RSEL Resistor Selection of Device Address Bits[A4:A0] (Continued)

Bits [A4:A0]	1% Resistor Value (kΩ)	Bits [A4:A0]	1% Resistor Value (kΩ)
10100	28.3	00100	452.5
10011	33.6	00011	538.2
10010	40	00010	640
10001	47.6	00001	761.1
10000	56.6	00000	905.1

Temperature Sensor Data

The temperature data format produces values up to and beyond the +105°C operating limit.

Table 15. Temperature/Data Relationship for 12-Bit Resolution

Temperature (°C)	Data Format	
	Binary	Hexadecimal
+150	0000 1001 0110 0000	0960h
+128	0000 1000 0000 0000	0800h
+125	0000 0111 1101 0000	07D0h
+85	0000 0101 0101 0000	0550h
+25.0625	0000 0001 1001 0001	0191h
+10.125	0000 0000 1010 0010	00A2h
+0.5	0000 0000 0000 1000	0008h
0	0000 0000 0000 0000	0000h
-0.5	1111 1111 1111 1000	FFF8h
-10.125	1111 1111 1111 1000	FFF8h
-25.0625	1111 1110 0110 1111	FE6Fh
-55	1111 1100 1001 0000	FC90h

THEORY OF OPERATION

Temperature Sensor Configuration and Status

One Shot

The one-shot function helps to reduce the average supply current when continuous conversions are not necessary. Before setting this bit, the application needs to reset the Conversion Period bits. Writing a 1 to D0 while in shutdown mode immediately prompts a new temperature conversion. After the conversion is complete, the device returns to shutdown mode and D0 automatically resets. If needed, the host can check the status of the one-shot bit to detect when the conversion is complete. If the device is configured for automatic sampling mode, and a conversion is in progress at the time a one-shot command is issued, it waits for the current conversion to complete before starting a new sequence. If the part is in automatic sampling mode but a conversion is not in progress, the one-shot command starts immediately. The host is able to reset the automatic conversion period and set the one-shot bit using a single write command to the configuration/status register.

Conversion Rate

The Conversion Rate bits, D3:D1, select the rate for automatic continuous conversions. Rates between 1 conversion/64 sec and 8 conversions/sec are available. The nominal conversion time is 35 ms at the default resolution of 10 bits. In automatic conversion mode, shutdown mode is entered between conversions to reduce the average power-supply current. Writing a value of 0b000 to this field causes the temperature sensor to enter shutdown mode. If a conversion is in progress at the time the value in this field is set to 0b000, the state of the machine allows the conversion to finish before entering shutdown.

Table 17. Conversion Rate Selection

D3	D2	D1	Conversion Rate
0	0	0	0 (shutdown)
0	0	1	1 conversion/64 second
0	1	0	1 conversion/32 second
0	1	1	1 conversion/16 second
1	0	0	1 conversion/4 second
1	0	1	1 conversion/second (default)
1	1	0	4 conversion/second
1	1	1	8 conversion/second

Packet Error Checking (PEC)

Set D4 to enable PEC. When enabled, a PEC byte is appended to the end of each message transfer. This is a CRC-8 byte that is calculated on all of the message bytes (including the address/read/write byte). The last device to transmit a data byte also transmits the PEC byte. The controller transmits the PEC byte after a write transaction, and the temperature sensor transmits the PEC byte after a read transaction.

Timeout

Write 1 to D5 to disable bus timeout. Write 0 to D5 to enable bus timeout. Bus timeout resets the I²C-compatible interface when SCL is low for more than 30 ms (nominal).

Resolution

The resolution bits (Bits[D7:D6]) select the conversion resolution. The conversion time doubles with every bit of increased resolution. For example, the nominal 10-bit conversion time is 35 ms. Increasing the resolution to 12 bits increases the conversion time to 140 ms. The resolution bits allow resolution, conversion time, and supply current to be optimized for the application's requirements. The bits in this field must only be changed when the temperature sensor is in shutdown mode.

Table 18. Resolution Selection

D7	D6	Resolution
0	0	8-bit
0	1	9-bit
1	0	10-bit
1	1	12-bit (default)

ALARM Polarity

When D8 is 0, the ALARM active state is low. The ALARM output is driven low when the temperature is above TH or below TL. When D8 is 1, the ALARM active state is high. The ALARM pin is pulled high when the temperature is above TH or below TL. If the hysteresis thresholds are programmed, after a temperature alarm, the ALARM pin status changes when the temperature falls below TH_HYST or above TL_HYST. Note that the behavior for both settings is dependent on the Fault Queue setting. The ALARM pin is an open-drain output and requires a pull-up resistor to operate.

Comparator and Interrupt

Set the D9 comparator and interrupt bit to 0 to make the overtemperature status (OT and UT status) bits operate in comparator mode. In comparator mode, the OT/UT status bits have a value of 1 when the temperature rises above the TH value or falls below TL, which is also subject to the fault queue selection. OT status returns to 0 when the temperature drops below the TH_HYST value or when shutdown mode is entered. Similarly, UT status returns to 0 when the temperature rises above TL_HYST value or when shutdown mode is entered.

Set bit D9 to 1 to operate OT/UT status bits in interrupt mode. Exceeding TH in this mode also sets OT status to 1, which remains set until a read operation is performed on the configuration/status register, at this point, it returns to 0. Once OT status is set to 1 from exceeding TH and reset, it is set to 1 again only when the temperature drops below TH_HYST. The output remains asserted until it is reset by a read. It is set again if the temperature rises

THEORY OF OPERATION

above TH, and so on. The same logic applies to the operation of the UT status bit.

Putting the temperature sensor into shutdown mode also resets the OT/UT status bits. Note that if the mode is changed while OT/UT status bits are set, an OT/UT status reset may be required before it begins to behave normally. To prevent this, it is recommended to perform a read of the configuration/status register to clear the status bits before changing the operating mode.

Fault Queue

The fault queue bits (Bits[D11:D10]) select how many consecutive temperature faults must occur before overtemperature or undertemperature faults are TH indicated in the corresponding status bits. The fault queue selection applies to both comparator and interrupt modes. The fault queue counter resets any time the temperature falls below TH or rises above TL. The fault counter does not change when the measured temperature drops below TH_HYST or is above TL_HYST thresholds. In interrupt mode, clearing the fault conditions is done using an I²C transaction by reading the configuration/status register. In comparator mode, the flags reset when the temperature measured is between TL_HYST and TH_HYST thresholds.

Table 19. Fault Queue Selection

D11	D10	Number of Faults
0	0	1 (default)
0	1	2
1	0	4
1	1	8

PEC Error

This bit is read-only. It is set to 1 by the device when the PEC enable bit is set. During an I²C transaction, the PEC value calculated by the device does not match the value sent by the host. When the PEC enable bit is 0, it remains 0.

Undertemperature Status

D14 is a read-only bit that indicates the temperature value is under the TL threshold. Its behavior is controlled by the comparator and interrupt and fault queue bits.

Overtemperature Status

D15 is a read-only bit that indicates that the temperature value is exceeding the value in the TH register. Its behavior is controlled by the comparator and interrupt and fault queue bits.

Temperature Threshold Alarm

Addresses 0x04 and 0x06 contain the 16-bit alarm thresholds, TH and TL. The default values for these registers are loaded at power up. The data format is the same as that of the temperature register. Once the part is powered up, the values can be changed using the

I²C interface. The memory used to store the settings is volatile, and the content of the registers is not retained if the power is powered down.

Before the register values are changed over I²C, the part must be in shutdown mode. For more details, see the [Configuration and Status Register](#) section. Operation in automatic mode can resume after the register update.

Alarm Hysteresis Thresholds

Addresses 0x08 and 0x0A contain the 16-bit alarm hysteresis thresholds, TH_HYST, and TL_HYST. The default values for these registers are loaded at power up and depend on the part option selected. The data format is the same as that of the temperature register. Once the part is powered up, the values can be changed using the I²C interface. The memory used to store the settings is volatile and the content of the registers is not stored upon power down.

TH_HYST is intended to have values less than or equal to TH, and TL_HYST value has to be equal of higher than TL for the part to operate correctly. Before the register values are changed over I²C, the part must be in shutdown mode. For more details, see the [Configuration and Status Register](#) Conversion Rate field. Operation in automatic mode can resume after the register update.

APPLICATIONS INFORMATION

TYPICAL APPLICATION DIAGRAM

Figure 84 shows the typical system-level block diagram of a floating voltmeter including power tree and digital isolators. Echo clock mode and controller clock mode relax the timing requirements and

simplify the use of digital isolators. Figure 84 to Figure 92 shows the typical application examples of differential signals applied to each of the ADAQ4224 inputs for a given gain.

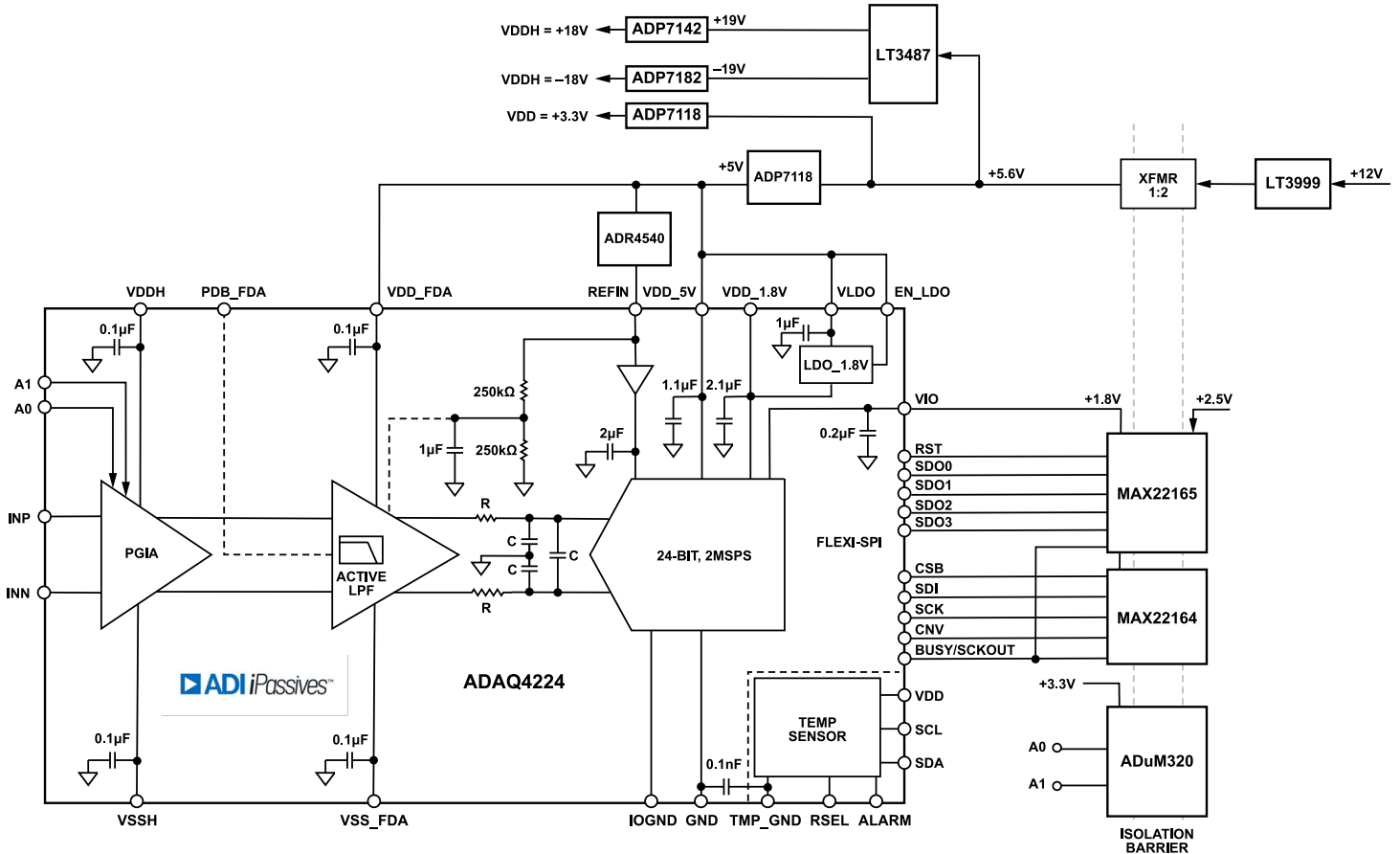

Figure 84. Functional Block Diagram of a Fully Isolated Data-Acquisition System

APPLICATIONS INFORMATION

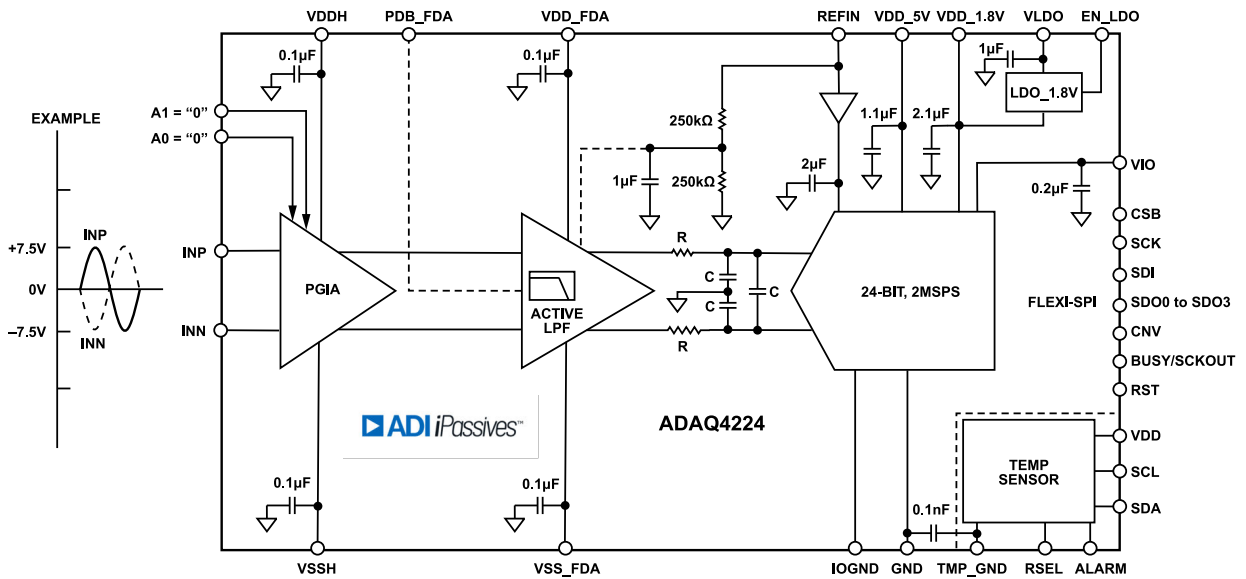

Figure 85. Differential Input Configuration with $G = 1/3 \text{ V/V}$

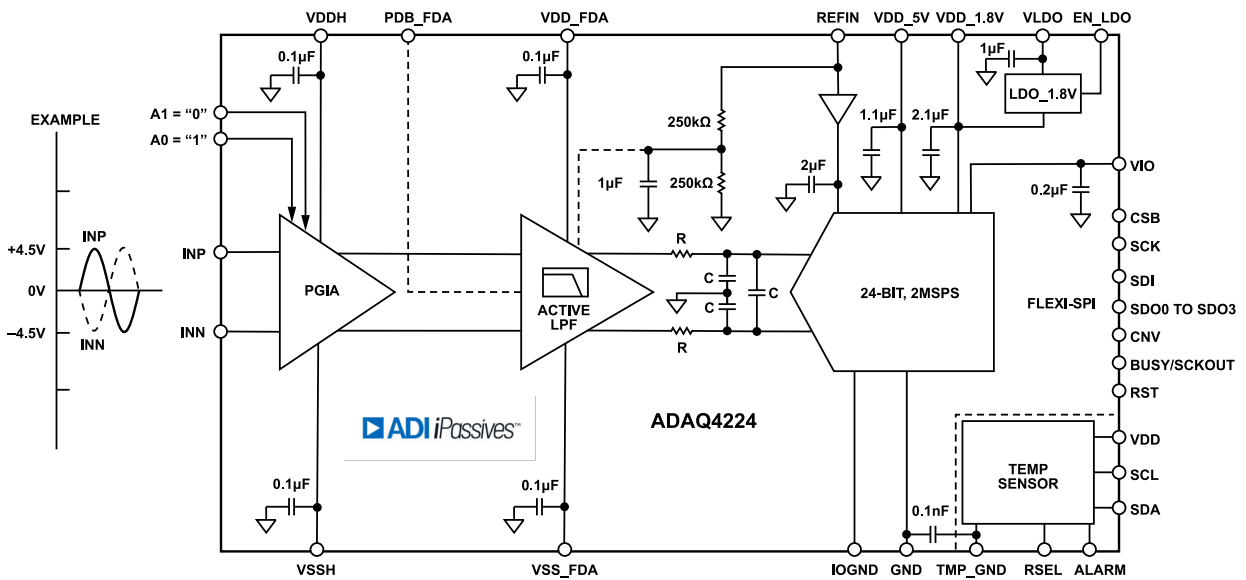

Figure 86. Differential Input Configuration with $G = 5/9 \text{ V/V}$

APPLICATIONS INFORMATION

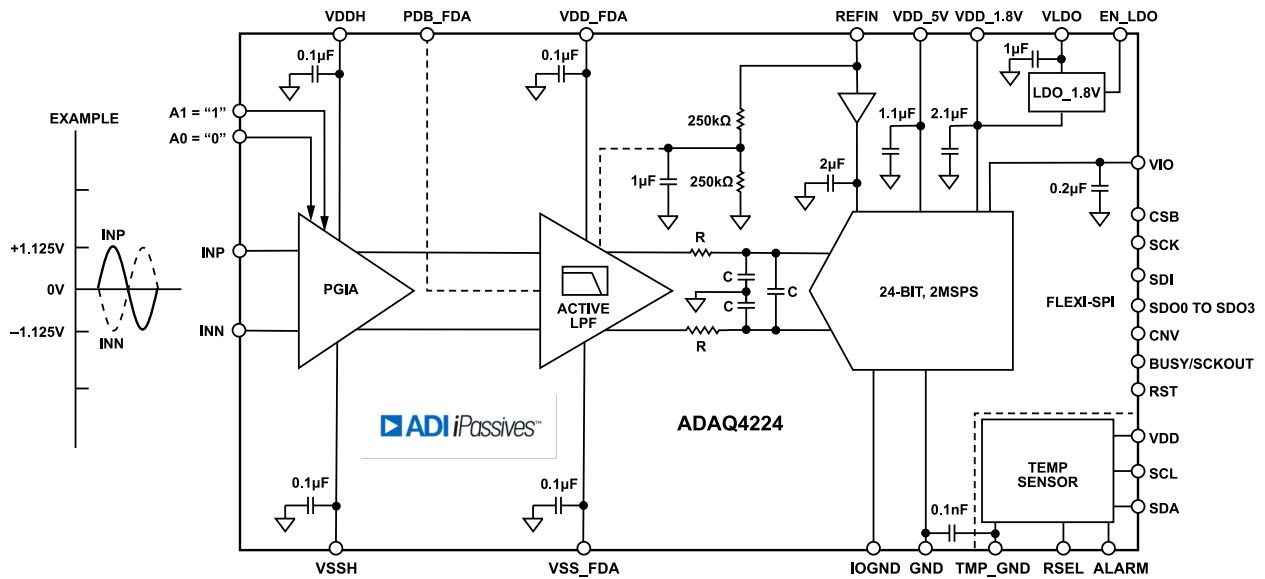

Figure 87. Differential Input Configuration with $G = 20/9 \text{ V/V}$

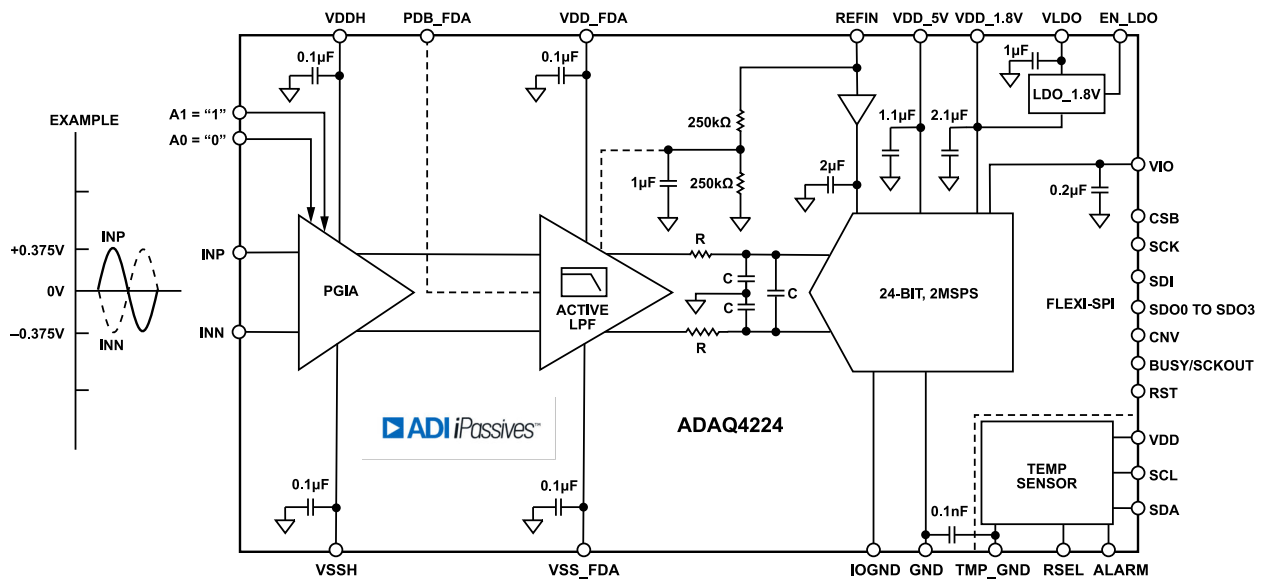

Figure 88. Differential Input Configuration with $G = 20/3 \text{ V/V}$

APPLICATIONS INFORMATION

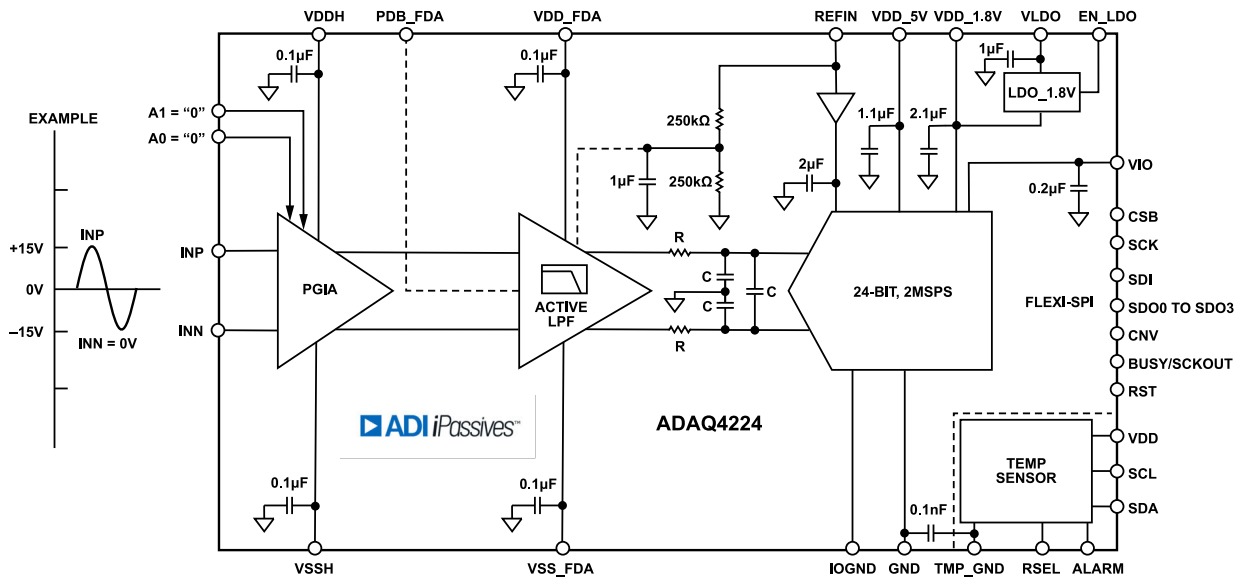

Figure 89. Single-Ended Input Configuration with $G = 1/3$ V/V

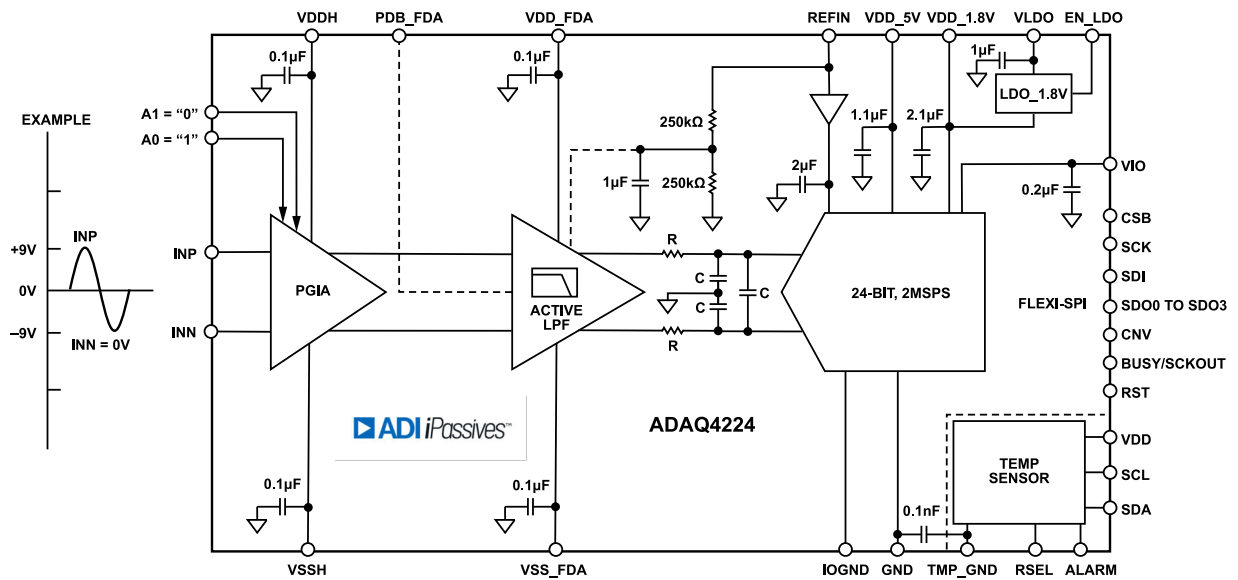

Figure 90. Single-Ended Input Configuration with $G = 5/9$ V/V

APPLICATIONS INFORMATION

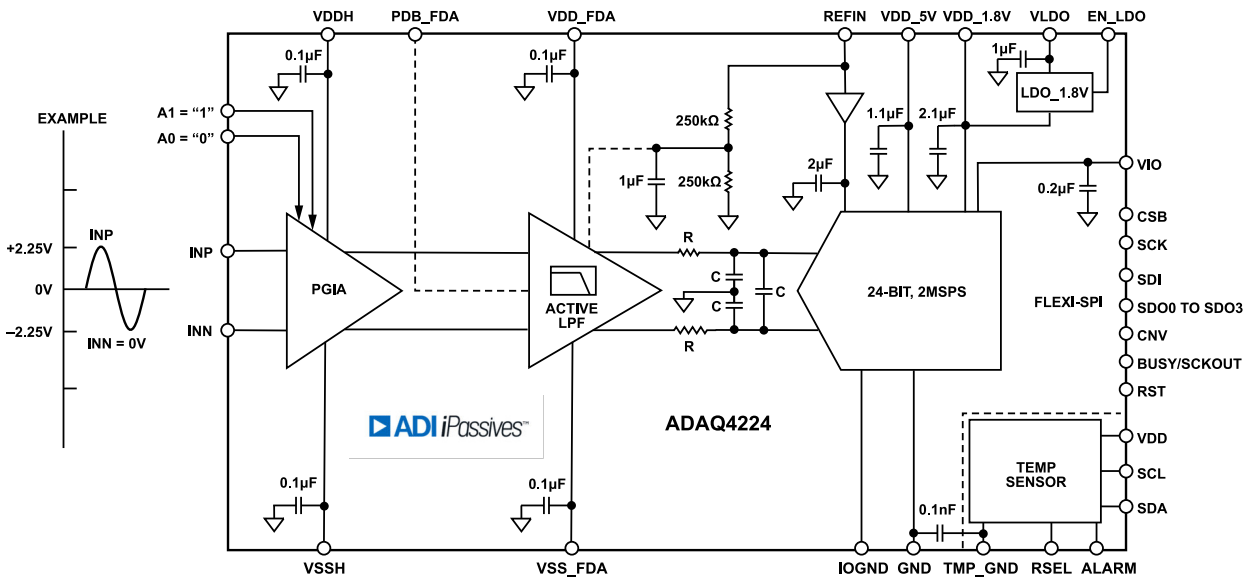

Figure 91. Single-Ended Input Configuration with $G = 20/9$ V/V

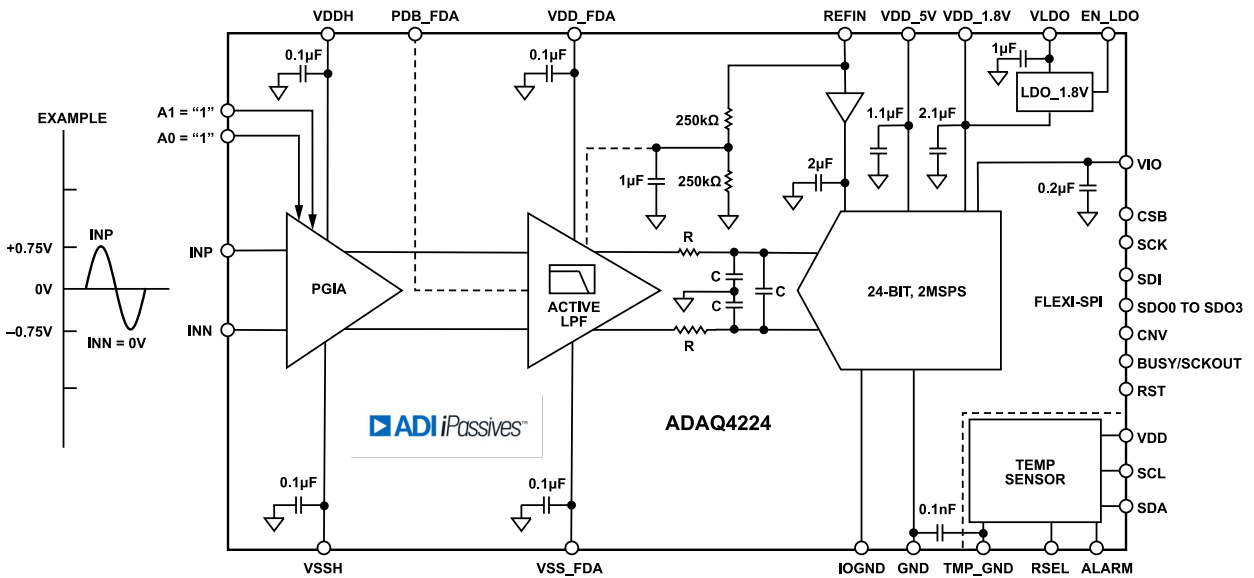

Figure 92. Single-Ended Input Configuration with $G = 20/3$ V/V

APPLICATIONS INFORMATION

REFERENCE CIRCUITRY DESIGN

The ADAQ4224 requires an external reference to define its input range. This reference must be within 4.096 V to 5 V. The optimal choice for a 4.096 V reference is the [ADR4540](#) or the [LTC6655LN-4.096](#), for a 5 V, use the [ADR4550](#) reference or the [LTC6655LN-5](#). The μ Module has several features that reduce the charge pulled from the reference, which makes the ADAQ4224 much easier to use than the discrete implementations. The external reference is connected to the REFIN pin, which has an internal precision buffer that isolates the reference from the μ Module circuitry. The buffer has a high-input impedance and draws a small input current (5 nA typical). The REFIN pin is also connected a 500 k Ω voltage divider that generates the V_{OCM} of the ADC driver, which draws an input current (10 μ A typical). An internal 2 μ F capacitor

on the output of the buffer provides optimal reference bypassing and simplifies PCB design by reducing component count and layout sensitivity. An RC circuit between the reference and the REFIN pin can be used to filter reference noise (see [Figure 93](#)). Suggested values are $100\ \Omega < R < 1\ \text{k}\Omega$, and $C \geq 10\ \mu\text{F}$.

In applications where a burst of samples is taken after idling for long periods, as shown in [Figure 94](#), the reference current (I_{REF}) changes from approximately 10 μ A to about 12 μ A at 2 MSPS. This step in DC current draw triggers a transient response in the reference that must be considered because any deviation in the reference output voltage affects the accuracy of the output code. If the reference is driving the REFIN pins, the internal buffer is able to handle these transitions.

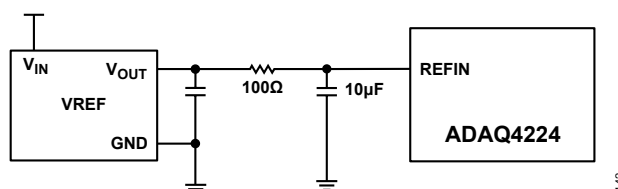

Figure 93. Reference with Noise Filter

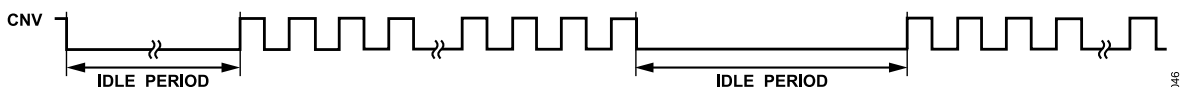

Figure 94. CNV Waveform Showing Burst Sampling

APPLICATIONS INFORMATION

ADC RESET

The ADAQ4224 provides two options for performing an ADC reset using the serial interface. A hardware reset is initiated by pulsing the voltage on the \overline{RST} pin low. A software reset is initiated by setting both the SW_RESET and SW_RESETX bits in the Interface Configuration A register to 1 in the same write instruction (for more details, see the [Interface Configuration A Register](#) section).

Performing a hardware or software reset asserts the RESET_OCCURRED bit in the digital diagnostics register (for more details, see the [Digital Diagnostics Register](#) section). The RESET_OCCURRED bit is cleared by writing the bit with a 1. RESET_OCCURRED can be used by the digital host to confirm that the ADAQ4224 has executed a device reset.

The ADAQ4224 is designed to generate a power-on reset (POR) when VDD_5V and VDD_1.8V are first applied. A POR resets the state of the user configuration registers and asserts the RESET_OCCURRED bit. If VDD_5V or VDD_1.8V drops below its specified operating range, a POR occurs. It is recommended to perform a hardware or software reset after a POR.

Figure 95 shows the timing diagram for performing an ADC reset using the RST input. The minimum RST pulse width is 50 ns, represented by t_{RESET_PW} in Figure 95 and Table 1. A reset must be performed no sooner than 3 ms after the power supplies are valid and stable (this delay is represented by t_{RESET_DELAY} in Figure 95 and Table 1).

After a hardware or software reset, no SPI commands or conversions can be started for 750 μ s.

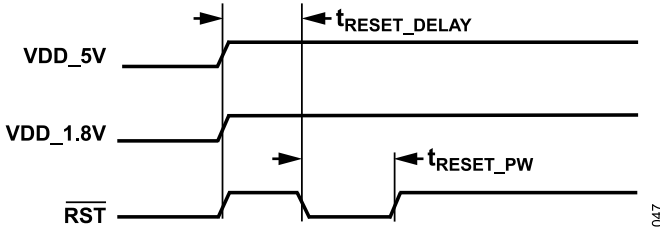

Figure 95. Power-On Reset (POR) Timing

POWER SUPPLIES

The recommended power-up sequence for the supply pins of the ADAQ4224 is shown in Figure 96. The recommended sequence is to power up the PGIA (VDDH and VSSH) first, then the FDA (VDD_FDA and VSS_FDA) along with the supplies of the ADC (VDD_5V, VLDO, and VIO), then bring up the reference voltage (REFIN) and lastly turn on the input signal at INP and INN pins. A user must adhere to the maximum voltage relationships described in the [Absolute Maximum Ratings](#) section.

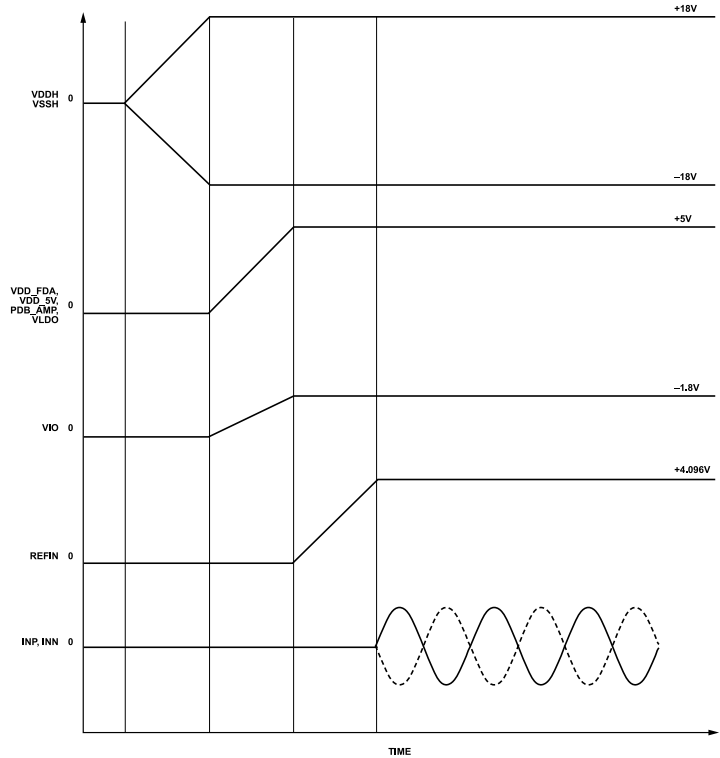

Figure 96. Power Supply Sequence

The voltage range for the VDD_5V supply depends on the chosen reference voltage (see the parameter Internal Reference Buffer in Table 1). Figure 97 shows the minimum and maximum values for VDD_5V with respect to REFIN. VDD_5V voltage values above the maximum or below the minimum result in either damage to the device or degraded performance.

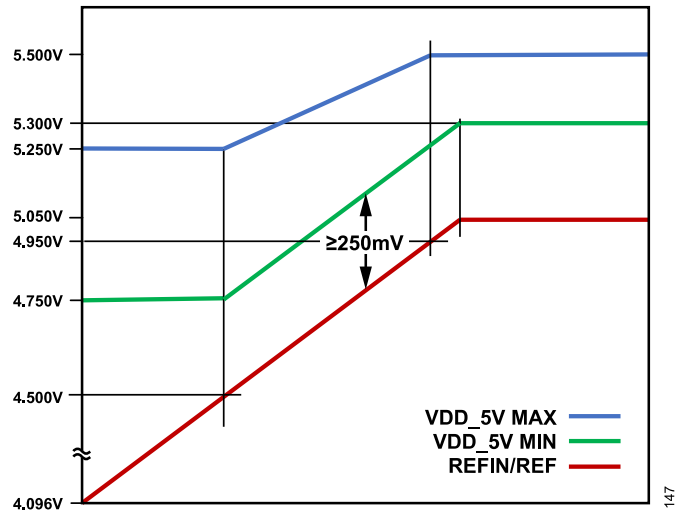

Figure 97. VDD_5V Minimum and Maximum Values for REFIN

The ADAQ4224 has a POR circuit that resets the ADAQ4224 at initial power-up or whenever VDD_5V or VDD_1.8V drops below its specified operating range.

APPLICATIONS INFORMATION

Note that the VDD_5V and the VLDO supplies have internal 1 μF bypass capacitors inside the package, VIO has an internal 0.2 μF bypass capacitor, while the VDDH, VSSH, VDD_FDA, VSS_FDA, and VDD have an internal 0.1 μF bypass capacitor. These internal capacitors reduce BOM count and solution size. If the bulk-supply bypass capacitors are not close to the ADC, add external capacitors next to the ADC. The minimum rise time for all supplies is 100 μs .

Power Consumption States

During a conversion, the power consumption of the ADAQ4224 is at its highest. When the conversion is complete, it enters a standby state and much of the internal circuitry is powered down, and current consumption drops to less than 20% relative to the conversion state. To ensure full accuracy, some circuitry, including the reference buffer, remains powered on during the standby state.

The device can be placed into a lower power shutdown state during periods when the convert clock is idle by writing 0x3 to the OPERATING_MODES bit field of the device configuration register (for more details, see the [Device Configuration Register](#) section). The default value of this bit field is [00] for normal operating mode. In the shutdown state, the current consumption typically drops to less than 10 μA .

Shutdown Mode

When the ADC enters shutdown mode, the internal reference buffer is disabled and a 500 Ω switch connects REFIN to the output of the internal reference buffer. This keeps the 2 μF capacitor on the output of the internal buffer charged up to allow fast recovery when the ADC exits shutdown mode. Because of this keep-alive switch, there is some charge injected to the REFIN pin when the ADC enters shutdown mode (400 pC) and exits shutdown mode (5 pC). When leaving shutdown mode, the output of the internal buffer is accurate after 30 μs .

SERIAL INTERFACE

The ADAQ4224 supports a multilane SPI serial digital interface with a common bit clock (SCK). The flexible VIO pins supply allows the ADAQ4224 to communicate with any digital logic operating between 1.2 V and 1.8 V. However, for the VIO pins levels less than 1.4 V, the IO2X bit in the output driver register must be set to 1 (for more details, see the [Output Driver Register](#) section). The serial output data is clocked out on up to 4 SDO lanes (see [Figure 98](#)). An echo clock mode that is synchronous with the output data is available to ease timing requirements when using isolation on the digital interface. A host clock mode is also available and uses an internal oscillator to clock out the data bits. The [SPI Clocking Mode](#), [Echo Clock Mode](#), [Host Clock Mode](#), [Single-Data Rate Mode](#), [Dual-Data Rate Mode](#), [1-Lane Output Data Clocking Mode](#), [2-Lane Output Data Clocking Mode](#), [4-Lane Output Data Clocking Mode](#), and [Data Output Modes Summary](#) sections describe the operation of the ADAQ4224 SPI.

The default communication mode upon power up is 1-Lane Mode, SPI Mode, SDR mode, and 24-bit differential data.

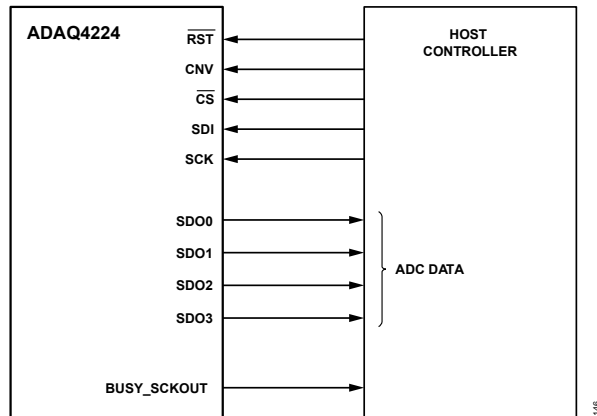

Figure 98. ADAQ4224 Multilane SPI

SPI SIGNALS

The SPI is a multilane interface that is used to both configure the ADC as well as retrieve sampled data. It consists of the following signals:

- ▶ \overline{CS} (input) (chip select). \overline{CS} must be set to low to initiate and enable a data transfer to or from the SDI pins or SDOx pins of the ADC. \overline{CS} timing for reading sample data can be moderated by observing the state of the BUSY pin. For echo clock mode and host clock mode, \overline{CS} timing must be controlled by the host processor because the BUSY_SCKOUT pin is used as the bit clock output for these clocking modes.
- ▶ SDI (input). Serial data input stream from the host controller to the ADC. The SDI signal is only used when writing data into one of the user registers of the ADAQ4224.
- ▶ CNV (input). The CNV signal is sourced by the host controller and initiates a sample conversion. The frequency of the CNV signal determines the sampling rate of the ADAQ4224. The maximum frequency of the CNV clock is 2 MSPS.

- ▶ SCK (input). Serial data clock sourced by the host controller. The maximum SCK rate supported for output data transfer is 100 MHz. For register reads and writes, the maximum SCK rate is 86 MHz for the VIO pins > 1.71 V, and 81 MHz for 1.14 V ≤ the VIO pins < 1.71 V.
- ▶ SDO0 through SDO3 (outputs). Data lanes to the host controller. The number of active data lanes can be either 1-lane, 2-lane, or 4-lane (see [Table 21](#)). The number of data lanes is configured in the [Modes Register](#) section.
- ▶ BUSY_SCKOUT (output). The behavior of the BUSY_SCKOUT pin is dependent on the selected clocking mode. [Table 20](#) defines the behavior of the BUSY_SCKOUT pin for each clocking mode.

Table 20. BUSY_SCKOUT Pin Behavior vs. Clocking Mode

Clocking Mode	Behavior
SPI Clocking Mode	Valid BUSY_SCKOUT pin signal for the ADC conversion status. The busy signal on the BUSY_SCKOUT pin goes high when a conversion is triggered by the CNV signal. The busy signal on the BUSY_SCKOUT pin goes low when the conversion is complete.
Echo Clock Mode	Bit clock. The BUSY_SCKOUT pin is a delayed version of SCK input.
Host Clock Mode	Bit clock. The BUSY_SCKOUT pin sources the clock signal from the internal oscillator.

Register Access Mode

The ADAQ4224 offers programmable user registers that are used to configure the device, as shown in the [Registers](#) section. By default, the device is in conversion mode during power-up. Therefore, to access the user registers, a special access command must be sent by the host controller over the SPI, as shown in [Figure 5](#). When this register access command is sent over the SPI, the device enters the register configuration mode. To readback the values from one of the user registers listed in the [Registers](#) section, the host controller must send the pattern shown in [Figure 4](#). To write to one of the user registers, the host controller must send the pattern shown in [Figure 3](#). In either case (read/write), the host controller must always issue 24 clock pulses on SCK line and pull \overline{CS} low for the entire transaction.

After writing to/reading from the appropriate user registers, the host controller must exit the register configuration mode by writing 0x01 to register address 0x0014 as detailed in the [EXIT Configuration Mode Register](#) section. An algorithm for register read/write access is as follows:

1. Perform a readback from a dummy register address 0x3FFF, to enter the register configuration mode.
2. Readback from or write to the required user register addresses.
3. Exit the register configuration mode by writing 0x01 to register address 0x0014. Exiting register configuration mode causes the register updates to take effect.

SERIAL INTERFACE

Stream Mode

The ADAQ4224 also offers a way to perform bulk register read/write transactions while the ADAQ4224 is in register configuration mode. To perform bulk read/write registers transactions, \overline{CS} must be kept low and SCK pulses must be issued in multiples of 8 as each register is only one byte (8 bits) wide. In stream mode, only address decrementing is allowed, which means that the user can read back from/write to the initial register address and register addresses that are directly below the initial register address. It is recommended that register accesses in stream mode be applied to register blocks

with contiguous addresses. However, it is possible to address registers that are not present in the register map. To do so, simply write all zeros to these registers, or, when reading back, simply discard the contents read from these registers since it is random data. To see which register address is valid and continuous, see the [Registers](#) section. For example, to readback a 24-bit offset value in one shot, the user must issue 24 SCK pulses starting from Register Address 0x0018. [Figure 99](#) shows timing diagram for bulk read starting at a given address.

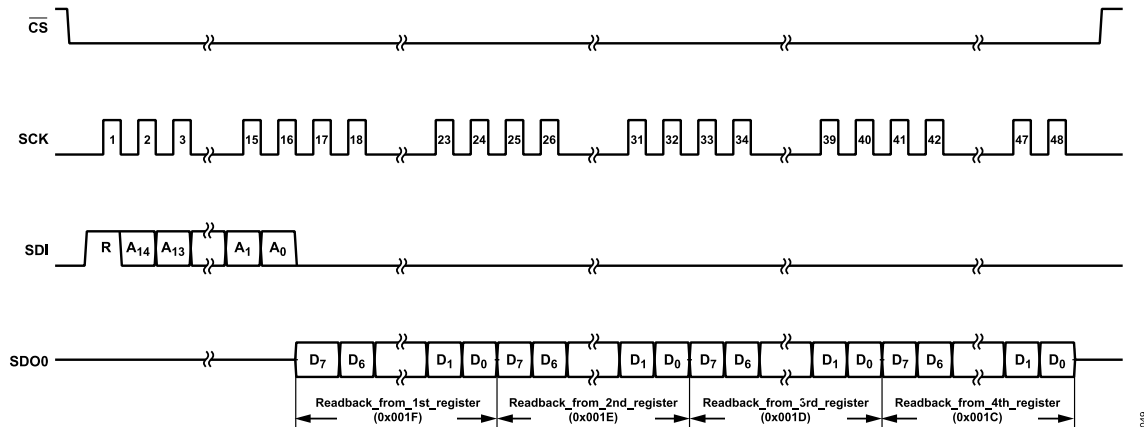

Figure 99. Stream Mode Bulk Register Readback Operation

SERIAL INTERFACE

SAMPLE CONVERSION TIMING AND DATA TRANSFER

A conversion is started on the rising edge of the CNV signal, as shown in Figure 100. Once the conversion is complete, CS can be asserted, which causes the current conversion result to be loaded into the output shift register.

As shown in Figure 100, there are two optional data transfer zones for sample N. Zone 1 represents the use case where CS is asserted immediately following the deassertion of BUSY signal for the sample N conversion (in SPI conversion mode), or after 300 ns for echo and host clock modes. For Zone 1, the available time to read out sample N is given by:

Zone 1 Data Read Window
 $= t_{CYC} - t_{CONV} - t_{QUIET_CNV_ADV}$

For example, if F_{CNV} is 2 MSPS ($t_{CYC} = 500$ ns) and using the typical value of t_{CONV} (282 ns), the available window width is 198.4 ns ($= 500$ ns $- 282$ ns $- 19.6$ ns).

Zone 2 represents the case where assertion of CS to read sample N is delayed until after the conversion for sample N+1 has been initiated.

To prevent data corruption, a quiet zone must be observed before and after each rising edge of the CNV signal, as shown in Figure 100. The quiet zone immediately before the rising edge of CNV is labeled as $t_{QUIET_CNV_ADV}$, and is equal to 19.6 ns. The quiet zone immediately after the rising edge of CNV is labeled $t_{QUIET_CNV_DELAY}$, and is equal to 9.8 ns. Assuming that the CS is asserted immediately after the quiet zone around the rising edge of CNV, the amount of time available to clock out the data is:

Zone 2 Data Read Window
 $= t_{CYC} - t_{QUIET_CNV_DELAY} - t_{QUIET_CNV_ADV}$

For example, if F_{CNV} is 2 MSPS ($t_{CYC} = 500$ ns) and using the typical value of t_{CONV} (282 ns), the available window width is 470.6 ns ($= 500$ ns $- 9.8$ ns $- 19.6$ ns). The Zone 2 transfer window is longer than the Zone 1 window. This can enable the use of a slower SCK on the SPI and ease the timing requirements for the interface. When using Zone 2 for the data transfer, it is recommended to assert CS immediately after the quiet zone. However, it must be asserted at least 25 ns before the falling edge of BUSY for sample N+1. If not, then sample N is overwritten with sample N+1.

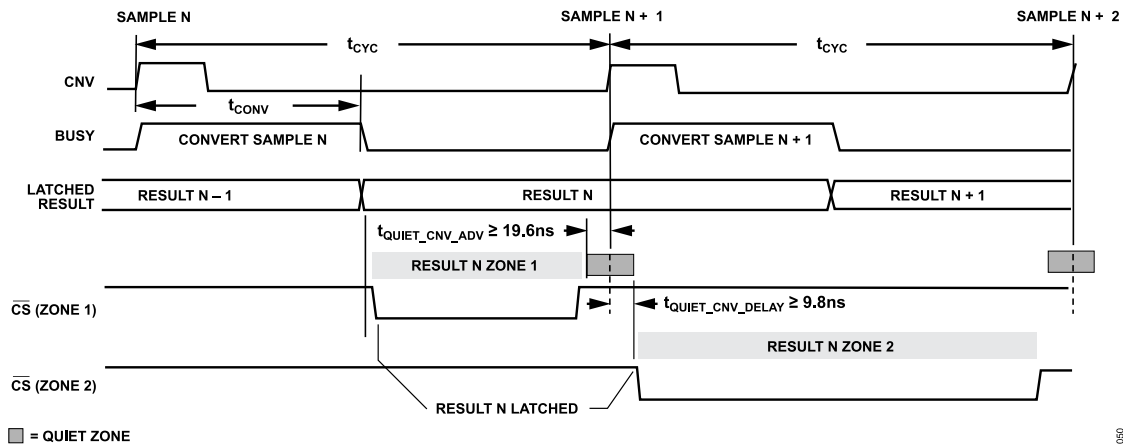

Figure 100. Example Timing for Data Transfer Zones

SERIAL INTERFACE

CLOCKING MODES

This section covers the various clocking modes supported by the ADAQ4224 SPI. These modes are available for 1-lane, 2-lane, and 4-lane. The clocking mode is configured in the modes register (for register descriptions, see [Table 23](#)).

SPI Clocking Mode

SPI clocking mode is the default clocking mode of the ADAQ4224 and is equivalent to a host-sourced bit clock (SCK), in which the host controller uses its own clock to latch the output data. The SPI-compatible clocking mode is enabled by writing 0x0 to the CLK_MD bit field of the modes register (for more details, see the

[Modes Register](#) section). The interface connection is shown in [Figure 98](#). In this mode, the BUSY_SCKOUT pin signal is valid and indicates that the completion of a conversion (high-to-low transition of the BUSY_SCKOUT pin). A simplified sample cycle is shown in [Figure 101](#). When not in averaging mode, if the host controller does not use the BUSY_SCKOUT pin signal to detect the completion of a conversion and instead uses an internal timer to retrieve the data, the host controller must wait at least 300 ns after the rising edge of the CNV pulse before asserting \overline{CS} low. When operating in block averaging mode, the host controller must assert \overline{CS} low no sooner than 300 ns after the rising edge of the CNV pulse for the last sample in the block.

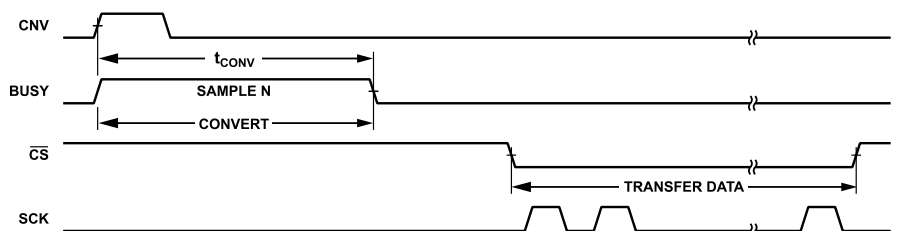

Figure 101. Typical Sample Cycle for SPI Clocking Mode

SERIAL INTERFACE

Echo Clock Mode

Figure 102 shows the signal connections for the echo clock mode. The echo clock mode is enabled by writing 0x1 to the CLK_MD bit field of the modes register (for more details, see the [Modes Register](#) section). In this mode, the BUSY_SCKOUT pin cannot be used to detect a conversion completion. The BUSY_SCKOUT pin becomes a bit clock output and is sourced by looping through the SCK of the host controller to the BUSY_SCKOUT pin (with some fixed delay, 5.4 ns to 7.9 ns, which depends on the voltage of the VIO pins). To begin retrieving the conversion data in nonaveraging mode, the host controller must assert \overline{CS} low no sooner than 300 ns after the rising edge of the CNV pulse. When the ADC is configured for block averaging mode, the host controller must assert \overline{CS} low no sooner than 300 ns after the rising edge of the CNV pulse for the last sample in the block. Example timing diagrams are shown in the [Data Clocking Requirements and Timing](#) section. When echo clock mode is enabled, the BUSY_SCKOUT pin is aligned with the SDOx pins transitions, which makes the data and clock timing insensitive to asymmetric propagation delays in the paths of the SDOx pins and SCK pins.

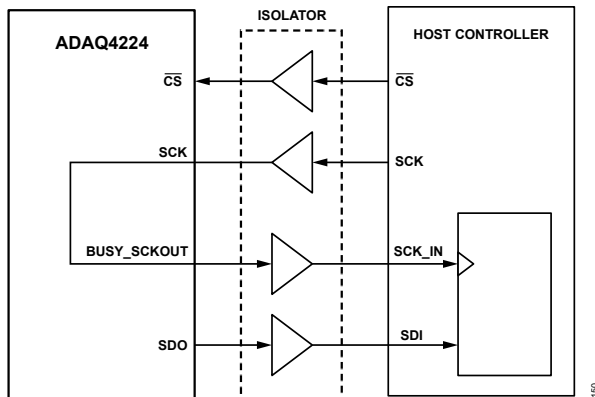

Figure 102. Echo Clock Mode Signal Path Diagram

Host Clock Mode

When enabled, host clock mode uses the internal oscillator as the bit clock source. The host clock mode is enabled by writing 0x2 to the CLK_MD bit field of the modes register. The bit clock frequency can be programmed in the OSC_DIV bit field in the internal oscillator register, with available divisor values of 1, 2, or 4 (for more details, see the [Internal Oscillator Register](#) section). Figure 103 shows the signal connections for the host clock mode. In this mode, the BUSY_SCKOUT pin provides the bit clock output and cannot be used to detect a conversion completion. The ADAQ4224 automatically calculates the number of clock pulses required to clock out the conversion data based on word size, number of active lanes, and choice of single-data rate mode or dual-data rate mode. The number of clock pulses can be read from the OSC_LIMIT bit field of the internal oscillator register. The SCK_IN from the host must not be active. When retrieving the conversion data in nonaveraging mode, the host must not assert \overline{CS} low sooner than

300 ns after the rising edge of the CNV pulse. When the ADC is configured in averaging mode for 2^N averages, the host must not assert \overline{CS} low sooner than 300 ns after the rising edge of the CNV pulse for the last sample in the block.

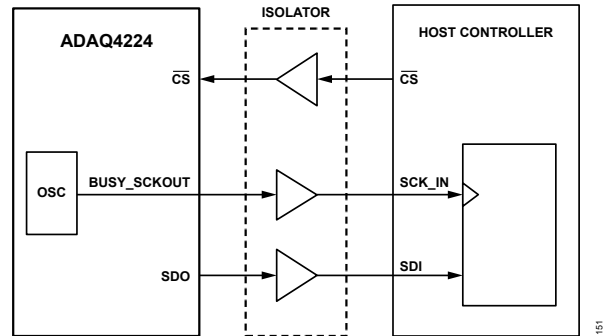

Figure 103. Host Clock Mode Signal Path Example

Single-Data Rate Mode

Single-data rate clocking (SDR), in which one bit (per active lane) is clocked out during a single clock cycle, is supported for all output configurations and sample formats (see [Table 21](#)). The SDR clocking mode is enabled by default at power-up or can be enabled by writing 0 to the DDR_MD bit of the modes register (for more details, see the [Modes Register](#) section).

Dual-Data Rate Mode

Dual-data rate (DDR) mode (two data bit transitions per clock cycle per active lane) is available only for host clock mode and echo clock mode.

The DDR clocking mode is enabled by writing 1 to the DDR_MD bit of the modes register (for more details, see the [Modes Register](#) section). The DDR mode uses half the number of SCK pulses to clock out conversion data in comparison to SDR mode.

1-Lane Output Data Clocking Mode

1-lane is the default output data clocking mode at power-up. The 1-lane output data clocking mode is enabled by writing 0x0 to the LANE_MD bit of the modes register (for more details, see the [Modes Register](#) section). The active lane is SDO0. Example timing diagrams for 1-lane mode using SPI clocking mode, echo clock mode, and host clock mode are shown in the [Data Clocking Requirements and Timing](#) section.

2-Lane Output Data Clocking Mode

When 2-lane output data clocking mode is enabled, the sample word bits are split between two SDO lanes. Figure 109 shows how the bits are allocated between the lanes for 2-lane mode. The bit arrangement is the same for SPI clock mode, echo clock mode, and host clock mode. A 2-lane output data clocking mode is enabled by writing 0x1 to the LANE_MD bit of the modes register (for more

SERIAL INTERFACE

details, see the [Modes Register](#) section). The host controller must recombine the data coming from the SDO lanes to reconstruct the original sample word. The number of SCK pulses required to clock out the conversion data is reduced by one-half with respect to the 1-lane mode. [Table 21](#) lists the active SDO lanes for 2-lane mode. Example timing diagrams for 2-lane mode using SPI clock mode, echo clock mode, and host clock mode are shown in the [Data Clocking Requirements and Timing](#) section.

4-Lane Output Data Clocking Mode

When 4-lane output data clocking mode is enabled, the sample word bits are split between four SDO lanes. [Figure 110](#) shows how the bits are allocated between the lanes for 4-lane mode. The bit arrangement is the same for SPI clock mode, echo clock mode, and

host clock mode. A 4-lane output data clocking mode is enabled by writing 0x2 to the LANE_MD bit of the modes register (for more details, see the [Modes Register](#) section). The host controller must recombine the data coming from the SDO lanes to reconstruct the original sample word. The number of SCK pulses required to clock out the conversion data is reduced by one-fourth with respect to the 1-lane output data clocking. The active SDO lanes for 4-lane mode are shown in [Table 21](#). Example timing diagrams for 4-lane mode using SPI clock mode, echo clock mode, and host clock mode are shown in the [Data Clocking Requirements and Timing](#) section.

Data Output Modes Summary

[Table 21](#) is a summary of the supported data output modes of the ADAQ4224.

Table 21. ADAQ4224 Supported Data Output Modes

Number of Lanes	Active SDO Lanes	Clock Mode	Supported Data Clocking Mode	Output Sample Data-Word Length
1	SDO0	SPI	SDR only	24 or 32
		Echo	SDR and DDR	24 or 32
		Host	SDR and DDR	24 or 32
2	SDO0, SDO1	SPI	SDR only	24 or 32
		Echo	SDR and DDR	24 or 32
		Host	SDR and DDR	24 or 32
4	SDO0, SDO1, SDO2, SDO3	SPI	SDR only	24 or 32
		Echo	SDR and DDR	24 or 32
		Host	SDR and DDR	24 or 32

SERIAL INTERFACE

DATA CLOCKING REQUIREMENTS AND TIMING

Basic and Averaging Conversion Cycles

Figure 104 shows the basic conversion cycle for a single sample. This cycle applies to SPI clocking mode. When using echo clock mode and host clock mode, the BUSY_SCKOUT pin function is disabled and the bit clock is sourced on the BUSY_SCKOUT pin. The data transfer must meet the requirements described in the Sample Conversion Timing and Data Transfer section.

Table 22 contains the minimum and maximum values for the conversion timing parameters, which apply to all clocking modes.

Table 22. Conversion Cycle Timing Parameters

Parameter	Min	Max
t _{CNVH}	10 ns	No specific maximum
t _{CNVL}	20 ns	No specific maximum
t _{CONV}	264 ns	300 ns

The duration of the data transfer period is dependent on the sample resolution, number of active lanes, SCK frequency, and data clocking mode (SDR or DDR). The nominal value of the transfer duration is given by:

$$\text{Data Transfer Duration} = t_{TRANS} = \frac{N_{BITS}}{M_{LANES}} \times \frac{1}{f_{SCK}} \times \frac{1}{K} \text{ seconds}$$

where:

N_{BITS} = number of bits to clock out.

M_{LANES} = number of lanes used to clock out the data (1, 2, or 4).

f_{SCK} = SCK clock frequency, in Hz.

K = 1 (SDR only, DDR not available for SPI mode clocking).

For a given f_{SCK}, number of data lanes, sample word size, and SDR/DDR mode, the minimum sample period when using Zone 1 for the data transfer is as follows:

Minimum Zone 1 Sample Period:

$$t_{CYC} \geq \left(\frac{N_{BITS}}{M_{LANES} \times f_{SCK} \times K} \right) + t_{CONV} + t_{QUIET_CNV_ADV}$$

The minimum sample period when using Zone 2 for data transfer is as follows:

$$t_{CYC} \geq \left(\frac{N_{BITS}}{M_{LANES} \times f_{SCK} \times K} \right) + t_{QUIET_CNV_DELAY} + t_{QUIET_CNV_ADV}$$

Figure 105 shows a typical conversion cycle when the averaging mode is active and SPI clocking mode is used. The BUSY signal is asserted for a number of CNV clock periods that is equal to the configured number of samples to be averaged. The averaged sample is then available when the BUSY signal is de-asserted. Similar to non-averaged mode, if the configured clocking mode is either echo clock or host clock, the BUSY signal is replaced by the output bit clock (SCKOUT). The host controller must manage the timing for asserting CS.

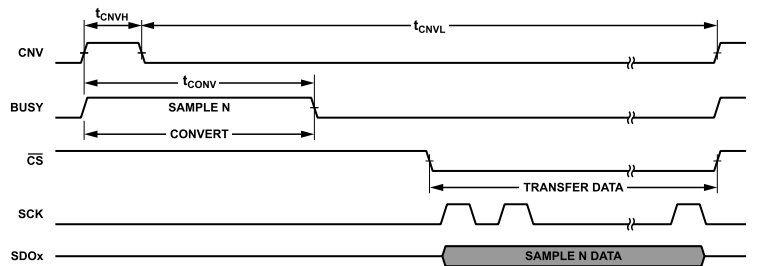

Figure 104. Basic Single Sample Conversion Cycle

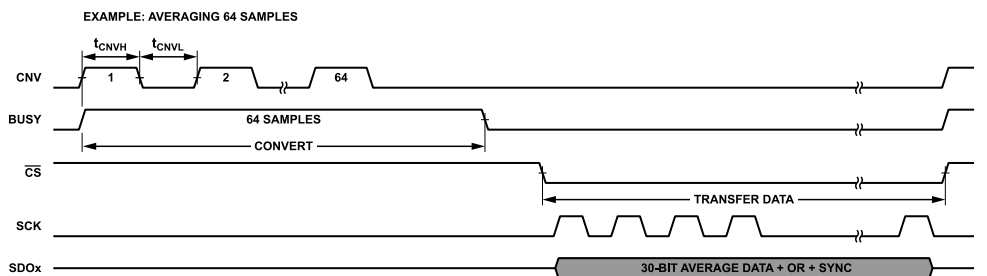

Figure 105. Example Conversion Cycle for Averaging Mode

SERIAL INTERFACE

The two transfer zones that exist in nonaveraging mode also exist in averaging mode (see Figure 106, Figure 107, and Figure 108).

To prevent data corruption, it is necessary to avoid SPI rising and falling edges signals taking place during quiet zones.

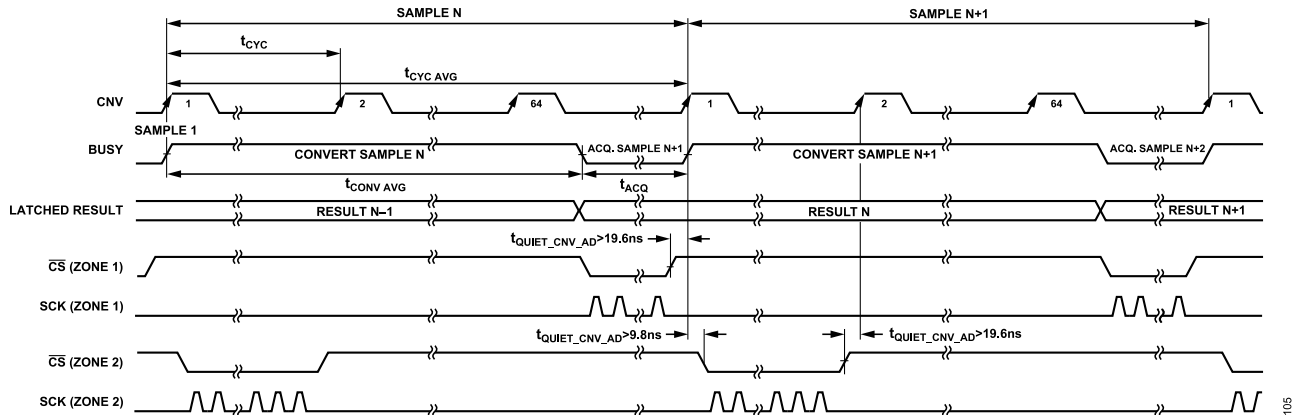

Figure 106. Example of Different Zones in Averaging Mode (64 Samples Averaged)

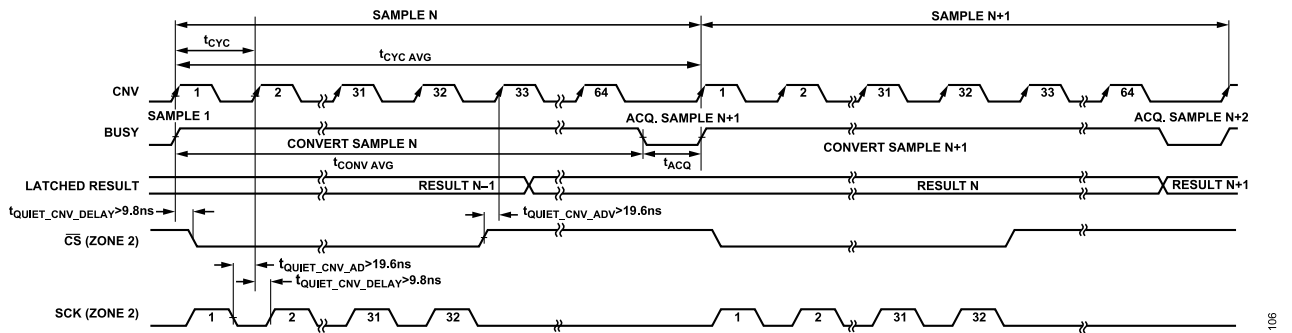

Figure 107. Example of Zone 2 in Averaging Mode (1 Bit per Sample)

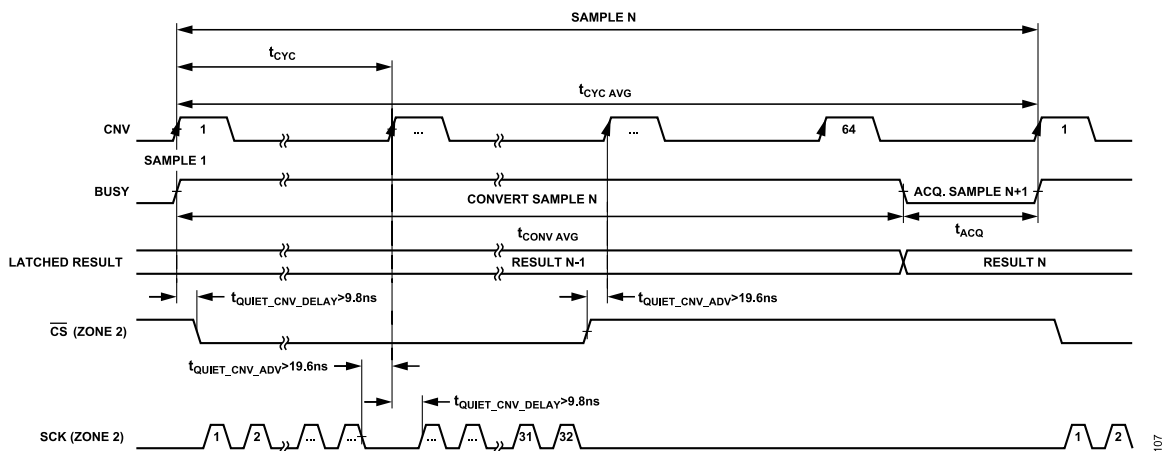

Figure 108. Example of Zone 2 in Averaging Mode (N Bits per Cycle)

SERIAL INTERFACE

SPI Clocking Mode Timing Diagrams

1-Lane, SDR Mode

Figure 6 shows a conversion cycle for 1-lane data output, SDR clocking mode (1-bit per clock cycle).

2-Lane, SDR Mode

Figure 109 shows a conversion cycle for 2-lane data output using SDR clocking mode. For more details, see the [2-Lane Output Data Clocking Mode](#) section.

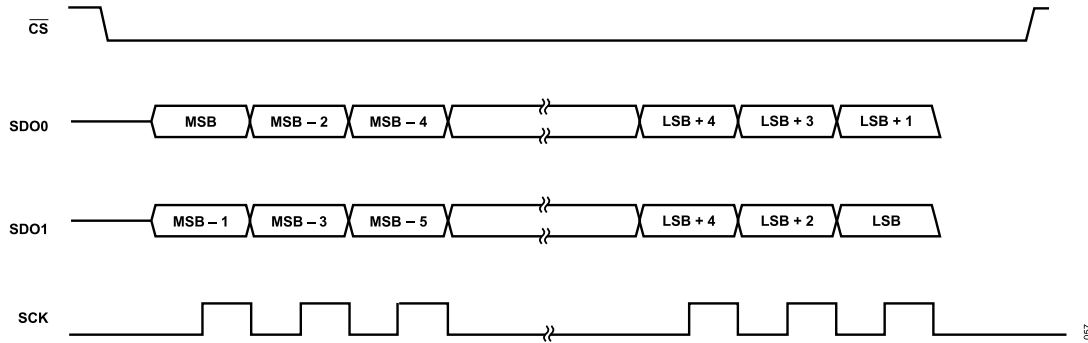

Figure 109. 2-Lane Mode, SDR Timing Diagram

SERIAL INTERFACE

4-Lane, SDR Mode

Figure 110 shows a conversion cycle for 4-lane data output using SDR clocking mode. For more details, see the [4-Lane Output Data Clocking Mode](#) section.

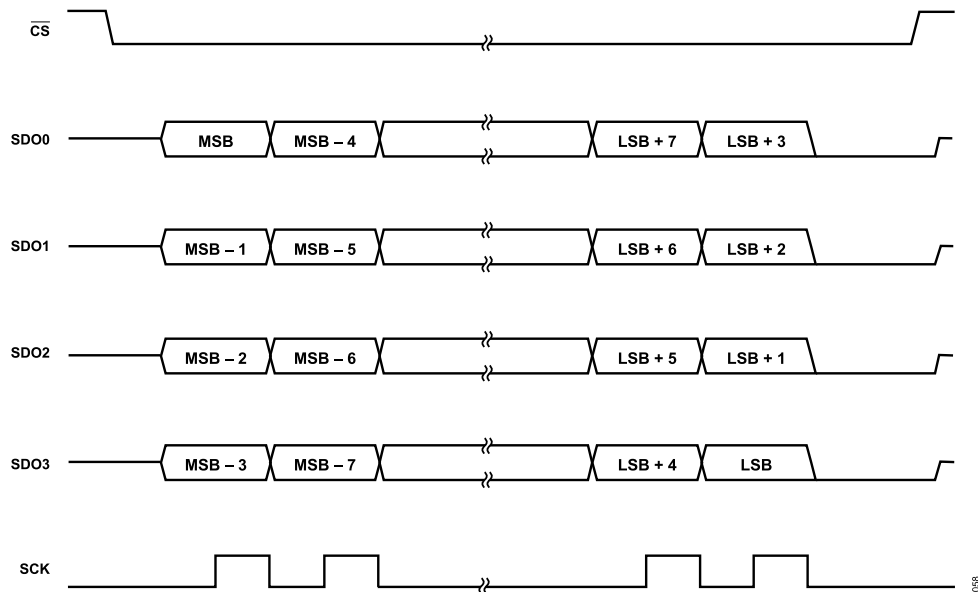

Figure 110. 4-Lane, SDR Timing Diagram

SERIAL INTERFACE

Echo Clock Timing Diagrams

1-Lane, SDR Mode, Echo Clock Mode

Figure 7 shows the timing relationships for SDR mode (1-bit per SCK period) in 1-lane echo clock mode. The timing relationships between the signals apply to both 24-bit and 32-bit sample word formats.

SCKOUT is a delayed version of the incoming SCK. The delay (t_{DSDO}) has a maximum value of 5.6 ns (at $V_{IO} > 1.71$ V). Changes in SDOx logic states are aligned to the rising edges of SCKOUT. The clock and data edge alignments are the same for 1-lane, 2-lane, and 4-lane output data modes.

1-Lane, DDR Mode, Echo Clock Mode

Figure 8 shows the timing relationships for DDR mode (2-bit transitions per SCKOUT period) in 1-lane mode echo clock mode. The timing relationships between the signals apply to both 24-bit and 32-bit sample word formats.

Similar to SDR mode, SCKOUT is a delayed version of the incoming SCK. Changes in SDOx logic states are aligned to both rising and falling edges of SCKOUT.

Host Clock Mode Timing

1-Lane, Host Clock Mode, SDR

Figure 9 shows the timing relationships for host clock mode when using SDR mode and 1-lane output data clocking mode. Similar to echo clock mode, the clock rising edges are aligned to the data bit transitions. The frequency of SCKOUT signal is controlled by the OSC_DIV value programmed in the internal oscillator register (for more details, see the [Internal Oscillator Register](#) section).

1-Lane, Host Clock Mode, DDR

Figure 10 shows the timing relationships for host clock mode when using DDR mode. Similar to echo clock mode, the rising and falling clock edges are aligned to the data bit transitions. The frequency of SCKOUT signal is controlled by the OSC_DIV value programmed in the internal oscillator register (for more details, see the [Internal Oscillator Register](#) section).

LAYOUT GUIDELINES

The following layout guidelines are recommended to achieve maximum performance of the ADAQ4224:

- ▶ The ADAQ4224 contains internal 1 μ F bypass capacitors for VDD_5V and VDD_1.8V, and VIO contains an internal 0.2 μ F capacitor. Therefore, no external bypass capacitors are required. This saves the board space and reduces the bill of materials (BOM) count and layout sensitivity.
- ▶ It is recommended to have all the analog signals flow in from the left side of the ADAQ4224 and all the digital signals to flow in and out from the right side of the ADAQ4224 because to help isolate analog signals from digital signals.
- ▶ Use a solid ground plane under the ADAQ4224 and connect all the analog ground (GND) pins and digital ground (IOGND) pins to the shared ground plane to avoid formation of ground loops.
- ▶ Traces routed to the REFIN pin must be isolated and shielded from other signals. Avoid routing signals beneath the reference trace (REFIN). If a noise reduction filter is placed between the output of the reference (or buffer) and the chosen reference input, it must be placed as close as possible to the ADAQ4224.

REGISTERS

The ADAQ4224 has programmable user registers that are used to configure the device. These registers can be accessed while the ADAQ4224 is in register configuration mode. Table 23 shows the complete list of the ADAQ4224 user registers and bit fields in the registers. The Register Details section shows the functions of each

of the bit fields. The access mode specifies whether the register is comprised only of read-only bits (R) or a mix of read-only and read/write bits (R/W). Read-only bits cannot be overwritten by an SPI write transaction, but read/write bits can.

Table 23. ADAQ4224 Register Summary

Reg	Name	Bits	Bit 7	Bit 6	Bit 5	Bit 4	Bit 3	Bit 2	Bit 1	Bit 0	Reset	R/W
0x00	INTERFACE_CONFIG_A	[7:0]	SW_RESET	RESERVED	ADDR_ASC ENSION	SDO_EN ABLE	RESERVED		SW_RES ETX	0x10	R/W	
0x01	INTERFACE_CONFIG_B	[7:0]	SINGLE_INST	STALLING	RESERVED		SHORT_INST RUCTION	RESERVED		0x00	R/W	
0x02	DEVICE_CONFIG	[7:0]	RESERVED						OPERATING_MO DES		0x00	R/W
0x03	CHIP_TYPE	[7:0]	RESERVED				CHIP_TYPE				0x07	R
0x04	PRODUCT_ID_L	[7:0]	PRODUCT_ID[7:0]								0x00	R
0x05	PRODUCT_ID_H	[7:0]	PRODUCT_ID[15:8]								0x20	R
0x06	CHIP_GRADE	[7:0]	GRADE				DEVICE_REVISION				0x00	R
0x0A	SCRATCH_PAD	[7:0]	SCRATCH_VALUE								0x00	R/W
0x0B	SPI_REVISION	[7:0]	SPI_TYPE		VERSION						0x81	R
0x0C	VENDOR_L	[7:0]	VID[7:0]								0x56	R
0x0D	VENDOR_H	[7:0]	VID[15:8]								0x04	R
0x0E	STREAM_MODE	[7:0]	LOOP_COUNT								0x00	R/W
0x11	INTERFACE_STATUS_A	[7:0]	RESERVED		CLOCK_C OUNT_ER R	RESERVED				0x00	R/W	
0x14	EXIT_CFG_MD	[7:0]	RESERVED						EXIT_CO NFIG_MD		0x00	R/W
0x15	AVG	[7:0]	AVG_SYNC	RESERVED		AVG_VAL				0x00	R/W	
0x16	OFFSET_LB	[7:0]	USER_OFFSET[7:0]								0x00	R/W
0x17	OFFSET_MB	[7:0]	USER_OFFSET[15:8]								0x00	R/W
0x18	OFFSET_HB	[7:0]	USER_OFFSET[23:16]								0x00	R/W
0x19	UNUSED1_LB	[7:0]	UNUSED1[7:0]								0x00	R/W
0x1A	UNUSED1_MB	[7:0]	UNUSED1[15:8]								0x00	R/W
0x1B	UNUSED1_HB	[7:0]	UNUSED1[23:16]								0x00	R/W
0x1C	GAIN_LB	[7:0]	USER_GAIN[7:0]								0x00	R/W
0x1D	GAIN_HB	[7:0]	USER_GAIN[15:8]								0x80	R/W
0x1E	UNUSED2_LB	[7:0]	UNUSED2[7:0]								0x00	R/W
0x1F	UNUSED2_HB	[7:0]	UNUSED2[15:8]								0x80	R/W
0x20	MODES	[7:0]	LANE_MD		CLK_MD	DDR_MD	OUT_DATA_MD			0x00	R/W	
0x21	OSCILLATOR	[7:0]	OSC_LIMIT				OSC_DIV				0x00	R/W
0x22	IO	[7:0]	RESERVED						IO2X		0x00	R/W
0x23	TEST_PAT_BYTE0	[7:0]	TEST_DATA_PAT[7:0]								0x0F	R/W
0x24	TEST_PAT_BYTE1	[7:0]	TEST_DATA_PAT[15:8]								0x0F	R/W
0x25	TEST_PAT_BYTE2	[7:0]	TEST_DATA_PAT[23:16]								0x5A	R/W
0x26	TEST_PAT_BYTE3	[7:0]	TEST_DATA_PAT[31:24]								0x5A	R/W
0x34	DIG_DIAG	[7:0]	POWERUP_CO MPLETED	RESET_OC CURRED	RESERVED				FUSE_CR C_EN		0x40	R/W
0x35	DIG_ERR	[7:0]	RESERVED						FUSE_CR C_ERR		0x00	R/W

REGISTER DETAILS

INTERFACE CONFIGURATION A REGISTER

Address: 0x00, Reset: 0x10, Name: INTERFACE_CONFIG_A

Interface configuration settings.

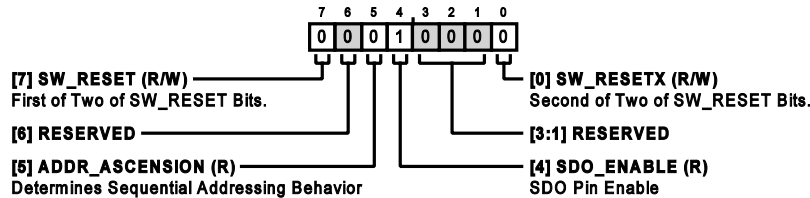

Table 24. Bit Descriptions for INTERFACE_CONFIG_A

Bits	Bit Name	Description	Reset	Access
7	SW_RESET	One of two of SW_RESET bits. This bit appears in two locations in this register. Both locations must be written at the same time to trigger a software reset of the part. All registers except for this register are reset to their default values.	0x0	R/W
6	RESERVED	Reserved.	0x0	R
5	ADDR_ASCENSION	Determines sequential addressing behavior. 0: Address accessed is decremented by one for each data byte when streaming. 1: Not a valid option.	0x0	R
4	SDO_ENABLE	SDO Pin Enable.	0x1	R
[3:1]	RESERVED	Reserved.	0x0	R
0	SW_RESETX	Two of two of SW_RESET bits. This bit appears in two locations in this register. Both locations must be written at the same time to trigger a software reset of the part. All registers except for this register are reset to their default values.	0x0	R/W

INTERFACE CONFIGURATION B REGISTER

Address: 0x01, Reset: 0x00, Name: INTERFACE_CONFIG_B

Additional interface configuration settings.

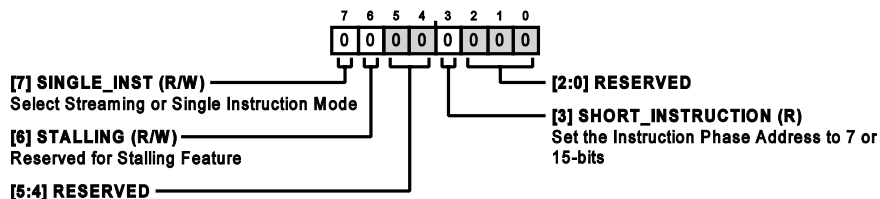

Table 25. Bit Descriptions for INTERFACE_CONFIG_B

Bits	Bit Name	Description	Reset	Access
7	SINGLE_INST	Select streaming or single instruction mode. 0: Streaming mode is enabled. The address decrements as successive data bytes are received. 1: Single instruction mode is enabled.	0x0	R/W
6	STALLING	Reserved for Stalling Feature.	0x0	R/W
[5:4]	RESERVED	Reserved.	0x0	R
3	SHORT_INSTRUCTION	Set the instruction phase address to 7 bits or 15 bits. 0: 15-bit addressing. 1: 7-bit addressing.	0x0	R
[2:0]	RESERVED	Reserved.	0x0	R

REGISTER DETAILS

DEVICE CONFIGURATION REGISTER

Address: 0x02, Reset: 0x00, Name: DEVICE_CONFIG

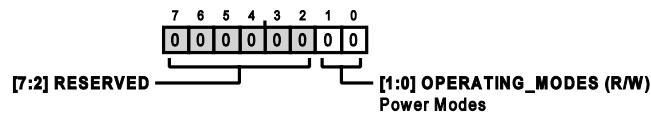

Table 26. Bit Descriptions for DEVICE_CONFIG

Bits	Bit Name	Description	Reset	Access
[7:2]	RESERVED	Reserved.	0x0	R
[1:0]	OPERATING_MODES	Power modes. 00: Normal operating mode. 11: Shutdown mode.	0x0	R/W

CHIP TYPE REGISTER

Address: 0x03, Reset: 0x07, Name: CHIP_TYPE

The chip type is used to identify the family of Analog Devices products a given device belongs to. Use the chip type with the product ID to uniquely identify a given product.

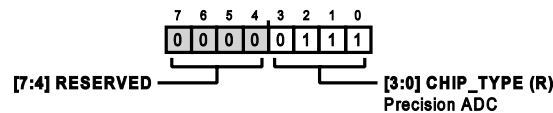

Table 27. Bit Descriptions for CHIP_TYPE

Bits	Bit Name	Description	Reset	Access
[7:4]	RESERVED	Reserved.	0x0	R
[3:0]	CHIP_TYPE	Precision ADC.	0x7	R

PRODUCT ID LOW REGISTER

Address: 0x04, Reset: 0x00, Name: PRODUCT_ID_L

Low byte of the product ID.

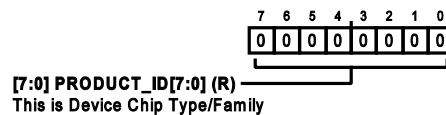

Table 28. Bit Descriptions for PRODUCT_ID_L

Bits	Bit Name	Description	Reset	Access
[7:0]	PRODUCT_ID[7:0]	This is the device chip type/family. Use the product ID with the chip type to identify a product.	0x0	R

PRODUCT ID HIGH REGISTER

Address: 0x05, Reset: 0x20, Name: PRODUCT_ID_H

High byte of the product ID.

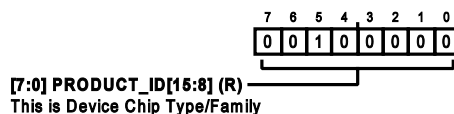

REGISTER DETAILS

Table 29. Bit Descriptions for PRODUCT_ID_H

Bits	Bit Name	Description	Reset	Access
[7:0]	PRODUCT_ID[15:8]	This is the device chip type/family. Use the product ID with the chip type to identify a product.	0x20	R

CHIP GRADE REGISTER

Address: 0x06, Reset: 0x81, Name: CHIP_GRADE

Identifies product variations and device revisions.

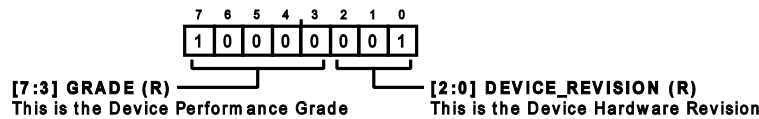

Table 30. Bit Descriptions for CHIP_GRADE

Bits	Bit Name	Description	Reset	Access
[7:3]	GRADE	This is the device performance grade. ADAQ4224: 0b11100.	0x1C	R
[2:0]	DEVICE_REVISION	This is the device hardware revision.	0x1	R

SCRATCH PAD REGISTER

Address: 0x0A, Reset: 0x00, Name: SCRATCH_PAD

This register can be used to test writes and reads.

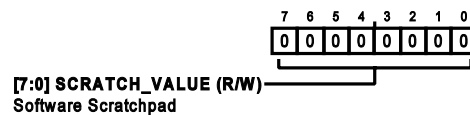

Table 31. Bit Descriptions for SCRATCH_PAD

Bits	Bit Name	Description	Reset	Access
[7:0]	SCRATCH_VALUE	Software Scratchpad. Software can write to and read from this location without any device side effects.	0x0	R/W

SPI REVISION REGISTER

Address: 0x0B, Reset: 0x81, Name: SPI_REVISION

Indicates the SPI revision.

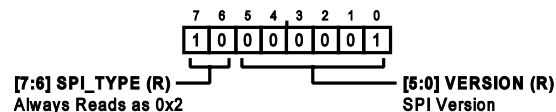

Table 32. Bit Descriptions for SPI_REVISION

Bits	Bit Name	Description	Reset	Access
[7:6]	SPI_TYPE	Always reads as 0x2.	0x2	R
[5:0]	VERSION	SPI Version.	0x1	R

REGISTER DETAILS

VENDOR ID LOW REGISTER

Address: 0x0C, Reset: 0x56, Name: VENDOR_L

Low byte of the vendor ID.

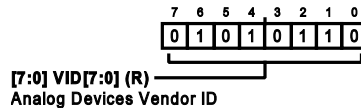

Table 33. Bit Descriptions for VENDOR_L

Bits	Bit Name	Description	Reset	Access
[7:0]	VID[7:0]	Analog Devices Vendor ID.	0x56	R

VENDOR ID HIGH REGISTER

Address: 0x0D, Reset: 0x04, Name: VENDOR_H

High byte of the vendor ID.

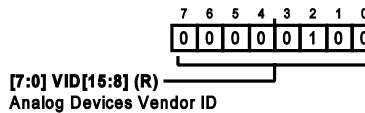

Table 34. Bit Descriptions for VENDOR_H

Bits	Bit Name	Description	Reset	Access
[7:0]	VID[15:8]	Analog Devices Vendor ID.	0x4	R

STREAM MODE REGISTER

Address: 0x0E, Reset: 0x00, Name: STREAM_MODE

Defines the length of the loop when streaming data.

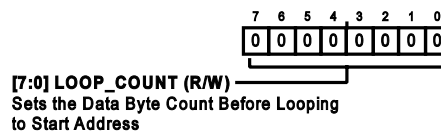

Table 35. Bit Descriptions for STREAM_MODE

Bits	Bit Name	Description	Reset	Access
[7:0]	LOOP_COUNT	Sets the data byte count before looping to start address. Not enabled in the ADAQ4224.	0x0	R/W

INTERFACE STATUS A REGISTER

Address: 0x11, Reset: 0x00, Name: INTERFACE_STATUS_A

Status bits are set to 1 to indicate an active condition. The status bits can be cleared by writing a 1 to the corresponding bit location.

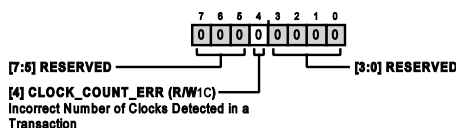

Table 36. Bit Descriptions for INTERFACE_STATUS_A

Bits	Bit Name	Description	Reset	Access
[7:5]	RESERVED	Reserved.	0x0	R

REGISTER DETAILS

Table 36. Bit Descriptions for INTERFACE_STATUS_A (Continued)

Bits	Bit Name	Description	Reset	Access
4	CLOCK_COUNT_ERR	0 = No error. 1 = Incorrect Number of Clocks Detected in a Transaction. Write 1 to clear.	0x0	R/W1C
[3:0]	RESERVED	Reserved.	0x0	R

EXIT CONFIGURATION MODE REGISTER

Address: 0x14, Reset: 0x00, Name: EXIT_CFG_MD

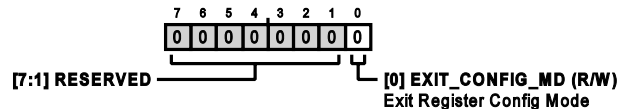

Table 37. Bit Descriptions for EXIT_CFG_MD

Bits	Bit Name	Description	Reset	Access
[7:1]	RESERVED	Reserved.	0x0	R
0	EXIT_CONFIG_MD	Exit Register Config Mode. Write 1 to exit register config mode. Self clearing upon $\overline{CS} = 1$.	0x0	R/W

AVERAGING MODE REGISTER

Address: 0x15, Reset: 0x00, Name: AVG

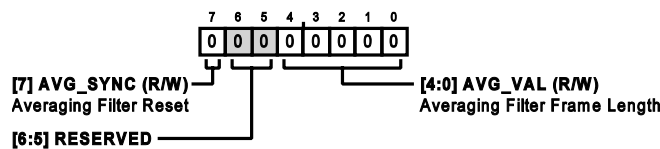
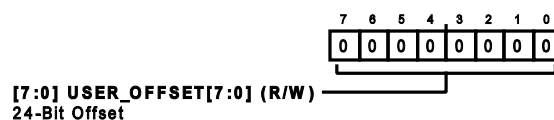

Table 38. Bit Descriptions for AVG

Bits	Bit Name	Description	Reset	Access
7	AVG_SYNC	Averaging Filter Reset. 1 = Reset, self clearing.	0x0	R/W
[6:5]	RESERVED	Reserved.	0x0	R
[4:0]	AVG_VAL	Averaging Filter Frame Length, 2^N . 0x00 = No averaging. Use only 0x01 through 0x10 for averaging mode. 0x01 = 2^1 samples. 0x02 = 2^2 samples. 0x03 = 2^3 samples. 0x04 = 2^4 samples. 0x05 = 2^5 samples. ... 0x0F = 2^{15} samples. 0x10 = 2^{16} samples. 0x11 through 0x1F = Invalid.	0x0	R/W

OFFSET REGISTERS

Address: 0x16, Reset: 0x00, Name: OFFSET_LB



REGISTER DETAILS

Table 39. Bit Descriptions for OFFSET_LB

Bits	Bit Name	Description	Reset	Access
[7:0]	USER_OFFSET[7:0]	24-Bit Offset. Twos complement (signed). $1 \text{ LSB} = \frac{V_{REF}}{2^{23}} / GAIN.$	0x0	R/W

Address: 0x17, Reset: 0x00, Name: OFFSET_MB

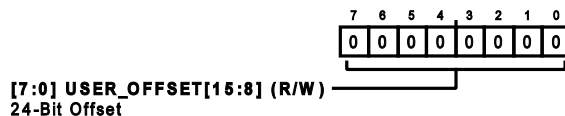

Table 40. Bit Descriptions for OFFSET_MB

Bits	Bit Name	Description	Reset	Access
[7:0]	USER_OFFSET[15:8]	24-Bit Offset. Twos complement (signed). $1 \text{ LSB} = \frac{V_{REF}}{2^{23}} / GAIN.$	0x0	R/W

Address: 0x18, Reset: 0x00, Name: OFFSET_HB

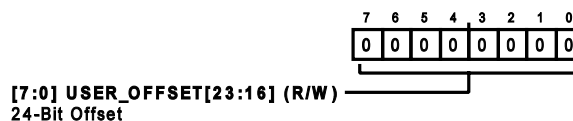

Table 41. Bit Descriptions for OFFSET_HB

Bits	Bit Name	Description	Reset	Access
[7:0]	USER_OFFSET[23:16]	24-Bit Offset. Twos complement (signed). $1 \text{ LSB} = \frac{V_{REF}}{2^{23}} / GAIN.$	0x0	R/W

GAIN REGISTERS

Address: 0x1C, Reset: 0x00, Name: GAIN_LB

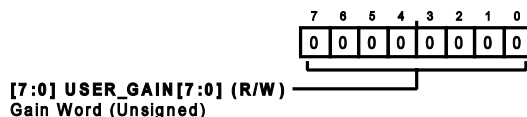
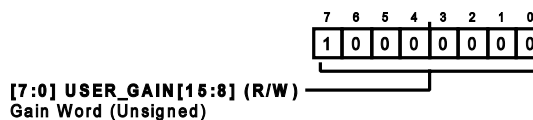

Table 42. Bit Descriptions for GAIN_LB

Bits	Bit Name	Description	Reset	Access
[7:0]	USER_GAIN[7:0]	Gain Word (Unsigned). Multiplier output = input × gain word/0x8000. Maximum effective gain = 0xFFFF/0x8000 = 1.99997.	0x0	R/W

Address: 0x1D, Reset: 0x80, Name: GAIN_HB



REGISTER DETAILS

Table 43. Bit Descriptions for GAIN_HB

Bits	Bit Name	Description	Reset	Access
[7:0]	USER_GAIN[15:8]	Gain Word (Unsigned). Multiplier output = input × gain word/0x8000. Maximum effective gain = 0xFFFF/0x8000 = 1.99997.	0x80	R/W

MODES REGISTER

Address: 0x20, Reset: 0x00, Name: MODES

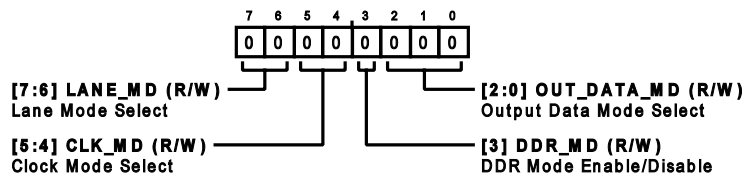

Table 44. Bit Descriptions for MODES

Bits	Bit Name	Description	Reset	Access
[7:6]	LANE_MD	Lane Mode Select. 00 = One lane. 01 = Two lanes. 10 = Four lanes. 11 = Invalid setting.	0x0	R/W
[5:4]	CLK_MD	Clock Mode Select. 00 = SPI clocking mode. 01 = Echo clock mode. 10 = Host clock mode. 11 = Invalid setting.	0x0	R/W
3	DDR_MD	DDR Mode Enable/Disable. 0 = SDR. 1 = DDR (only valid for echo clock mode and host clock mode).	0x0	R/W
[2:0]	OUT_DATA_MD	Output Data Mode Select. 000 = 24-bit differential data. 001 = 16-bit differential data + 8-bit common-mode data. 010 = 24-bit differential data + 8-bit common-mode data. 011 = 30-bit averaged differential data + OR bit + SYNC bit. 100 = 32-bit test data pattern (TEST_DATA_PAT).	0x0	R/W

INTERNAL OSCILLATOR REGISTER

Address: 0x21, Reset: 0x00, Name: OSCILLATOR

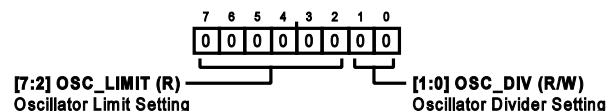

Table 45. Bit Descriptions for OSCILLATOR

Bits	Bit Name	Description	Reset	Access
[7:2]	OSC_LIMIT	Oscillator Limit Setting. Oscillator is limited to this number of clock pulses plus one. Automatically calculated by the ADAQ4224 based on the data-word size, number of active SDO lanes, and data rate mode (SDR or DDR).	0x0	R
[1:0]	OSC_DIV	Oscillator Divider Setting. 00 = No divide (divide by 1). 01 = Divide by 2.	0x0	R/W

REGISTER DETAILS

Table 45. Bit Descriptions for OSCILLATOR (Continued)

Bits	Bit Name	Description	Reset	Access
		10 = Divide by 4. 11 = Invalid setting.		

OUTPUT DRIVER REGISTER

Address: 0x22, Reset: 0x00, Name: IO

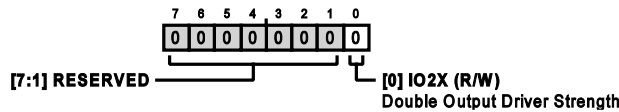

Table 46. Bit Descriptions for IO

Bits	Bit Name	Description	Reset	Access
[7:1]	RESERVED	Reserved.	0x0	R
0	IO2X	Double Output Driver Strength. 1 = Double output driver strength. 0 = Normal output driver strength.	0x0	R/W

TEST PATTERN REGISTERS

Address: 0x23, Reset: 0x0F, Name: TEST_PAT_BYTE0

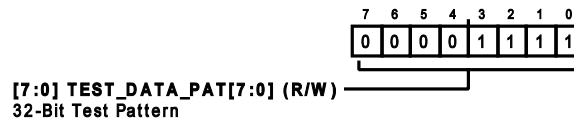

Table 47. Bit Descriptions for TEST_PAT_BYTE0

Bits	Bit Name	Description	Reset	Access
[7:0]	TEST_DATA_PAT[7:0]	32-Bit Test Pattern. Applied when OUT_DATA_MD = 4.	0xF	R/W

Address: 0x24, Reset: 0x0F, Name: TEST_PAT_BYTE1



Table 48. Bit Descriptions for TEST_PAT_BYTE1

Bits	Bit Name	Description	Reset	Access
[7:0]	TEST_DATA_PAT[15:8]	32-Bit Test Pattern. Applied when OUT_DATA_MD = 4.	0xF	R/W

Address: 0x25, Reset: 0x5A, Name: TEST_PAT_BYTE2

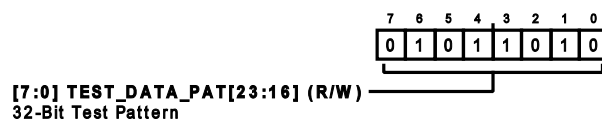

Table 49. Bit Descriptions for TEST_PAT_BYTE2

Bits	Bit Name	Description	Reset	Access
[7:0]	TEST_DATA_PAT[23:16]	32-Bit Test Pattern. Applied when OUT_DATA_MD = 4.	0x5A	R/W

REGISTER DETAILS

Address: 0x26, Reset: 0x5A, Name: TEST_PAT_BYTE3

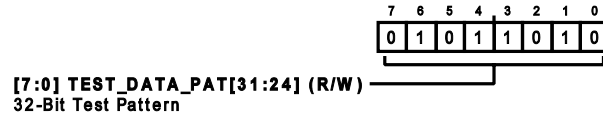

Table 50. Bit Descriptions for TEST_PAT_BYTE3

Bits	Bit Name	Description	Reset	Access
[7:0]	TEST_DATA_PAT[31:24]	32-Bit Test Pattern. Applied when OUT_DATA_MD = 4.	0x5A	R/W

DIGITAL DIAGNOSTICS REGISTER

Address: 0x34, Reset: 0x40, Name: DIG_DIAG

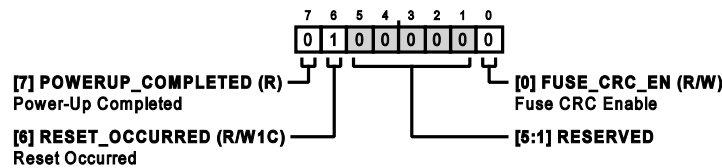

Table 51. Bit Descriptions for DIG_DIAG

Bits	Bit Name	Description	Reset	Access
7	POWERUP_COMPLETED	1 = Power-Up Completed. Self clearing.	0x0	R
6	RESET_OCCURRED	Reset Occurred. This bit is set to 1 upon a reset event. Write 1 to clear (useful for detecting brownouts).	0x1	R/W1C
[5:1]	RESERVED	Reserved.	0x0	R
0	FUSE_CRC_EN	Fuse CRC Enable. Write a 1 to force recheck of CRC.	0x0	R/W

DIGITAL ERRORS REGISTER

Address: 0x35, Reset: 0x00, Name: DIG_ERR

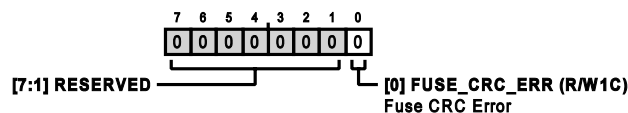

Table 52. Bit Descriptions for DIG_ERR

Bits	Bit Name	Description	Reset	Access
[7:1]	RESERVED	Reserved.	0x0	R
0	FUSE_CRC_ERR	Fuse CRC Error. This bit is set to 1 upon a fuse CRC error. Write 1 to clear.	0x0	R/W1C

TEMPERATURE SENSOR REGISTERS

The ADAQ4224 has programmable user registers that are used to control and configure the temperature sensor. The registers are organized, as shown in [Table 53](#). All memory commands are described in detail in the Function Commands column.

Table 53. Temperature Sensor Register Summary

Offset	Read or Write	Register Name		Function Commands
0x00	R	T_MSB	T_LSB	Temperature 16-bit word.
0x02	R/W	CONFIGURATION/STATUS		Configuration/Status.
0x04	R/W	TH_MSB	TH_LSB	Alarm threshold high 16-bit word.
0x06	R/W	TL_MSB	TL_LSB	Alarm threshold low 16-bit word.
0x08	R/W	TH_HYST_MSB	TH_HYST_LSB	Hysteresis high threshold 16-bit word.
0x0A	R/W	TL_HYST_MSB	TL_HYST_LSB	Hysteresis low threshold 16-bit word.

TEMPERATURE SENSOR REGISTER DETAILS

CONFIGURATION AND STATUS REGISTER

Address 0x02, Name: CONFIGURATION/STATUS

Table 54. Bit Descriptions for CONFIGURATION/STATUS Register

Bits	Bit Name	Description	Reset	Access
15	OVER TEMP STATUS	Indicates that the measured temperature is above the high threshold temperature. Behavior is set by the COMPARATOR/INTERRUPT and FAULT QUEUE bits.	0b0	R
14	UNDER TEMP STATUS	Indicates that the measured temperature is under the low threshold temperature. Behavior is set by the COMPARATOR/INTERRUPT and FAULT QUEUE bits.	0b0	R
13	PEC ERROR	1 = When PEC enable bit is 1. 0 = When PEC enable bit is 0.	0b0	R
12	RESERVED	Reserved.	0b0	R
[11:10]	FAULT QUEUE	Sets how many consecutive temperature faults must occur before over temperature or under temperature faults are indicated in the status bits.	0b00	R/W
9	COMP/INT	1 = OT and UT status bits in interrupt mode. 0 = OT and UT status bits in comparator mode.	0b0	R/W
8	ALARM POLARITY	1 = ALARM pin active state is low. 0 = ALARM pin active state is high.	0b0	R/W
[7:6]	RESOLUTION	Sets the temperature conversion resolution.	0b11	R/W
5	TIMEOUT	1 = Disables bus timeout. 0 = Enable bus timeout.	0b0	R/W
4	PEC ENABLE	1 = A PEC byte is appended to the end of each message transfer.	0b0	R/W
[3:1]	CONVERSION RATE	0b000 = Shutdown mode, else automatic conversion mode. If conversion is on going when this field is set to 0b000, the device completes the conversion first before entering shutdown mode.	0b101	R/W
0	ONE-SHOT	Set CONVERSION RATE bits first before setting this bit to 1. 1 = Prompts a new temperature conversion. Shutdown mode : Returns to 0 after temperature conversion. Automatic sampling mode: Complete ongoing conversion before starting a new sequence.	0b0	R/W

OUTLINE DIMENSIONS

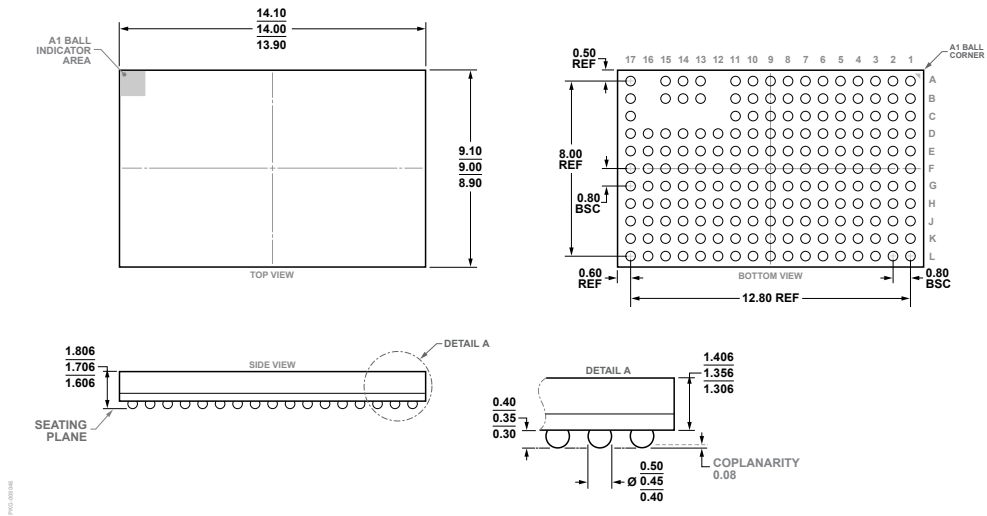

Figure 111. 178-Ball Chip-Scale Package, Ball Grid Array [CSP_BGA] (BC-178-2)
Dimensions Shown in millimeters

Updated: September 03, 2024

ORDERING GUIDE

Model ¹	Temperature Range	Package Description	Packing Quantity	Package Option
ADAQ4224BBCZ	-40°C to +105°C	178-Lead, BGA (14 mm × 9 mm × 0.8 mm)	Tray, 182	BC-178-2

¹ Z = RoHS-Compliant Part.

EVALUATION BOARDS

Evaluation Board ¹	Description
EVAL-ADAQ4224-FMCZ	Evaluation Board

¹ Z = RoHS-Compliant Part.