

Final datasheet

EasyDUAL module with TRENCHSTOP™ IGBT7 and emitter controlled 7 diode and PressFIT / NTC

Features

- Electrical features
 - $V_{CES} = 1200\text{ V}$
 - $I_{C\text{ nom}} = 100\text{ A} / I_{CRM} = 200\text{ A}$
 - Overload operation up to 175°C
 - Low $V_{CE,\text{sat}}$
 - TRENCHSTOP™ IGBT7
 - Suitable Infineon gate drivers can be found under <https://www.infineon.com/gdfinder>
- Mechanical features
 - High power density
 - Compact design
 - Al_2O_3 substrate with low thermal resistance
 - PressFIT contact technology
 - 2.5 kV AC 1 minute insulation
 - Integrated NTC temperature sensor



Typical appearance

Potential applications

- Motor drives
- Air conditioning
- Auxiliary inverters
- Servo drives
- UPS systems

Product validation

- Qualified for industrial applications according to the relevant tests of IEC 60747, 60749 and 60068

Description

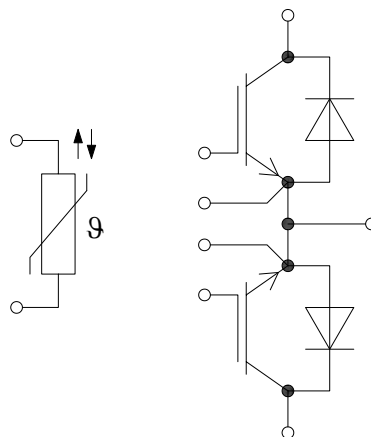

Table of contents

	Description	1
	Features	1
	Potential applications	1
	Product validation	1
	Table of contents	2
1	Package	3
2	IGBT, Inverter	3
3	Diode, Inverter	5
4	NTC-Thermistor	6
5	Characteristics diagrams	7
6	Circuit diagram	12
7	Package outlines	13
8	Module label code	14
	Revision history	15
	Disclaimer	16

1 Package

Table 1 Insulation coordination

Parameter	Symbol	Note or test condition	Values	Unit
Isolation test voltage	V_{ISOL}	RMS, $f = 50 \text{ Hz}$, $t = 1 \text{ min}$	2.5	kV
Internal isolation		basic insulation (class 1, IEC 61140)	Al_2O_3	
Comparative tracking index	CTI		> 200	
Relative thermal index (electrical)	RTI	housing	140	°C

Table 2 Characteristic values

Parameter	Symbol	Note or test condition	Values			Unit
			Min.	Typ.	Max.	
Stray inductance module	L_{sCE}			20		nH
Module lead resistance, terminals - chip	$R_{CC'+EE'}$	$T_H = 25 \text{ °C}$, per switch		4.2		mΩ
Storage temperature	T_{stg}		-40		125	°C
Mounting force per clamp	F		20		50	N
Weight	G			24		g

*Note: The current under continuous operation is limited to 25 A rms per connector pin.
The electrical characterization was performed in NPC2 topology, which combines two FF100R12W1T7E_B11 modules. It has to be considered, that the commutation in this configuration takes place between both modules.*

2 IGBT, Inverter

Table 3 Maximum rated values

Parameter	Symbol	Note or test condition		Values	Unit
Collector-emitter voltage	V_{CES}		$T_{vj} = 25 \text{ °C}$	1200	V
Implemented collector current	I_{CN}			100	A
Continuous DC collector current	I_{CDC}	$T_{vj \text{ max}} = 175 \text{ °C}$	$T_H = 65 \text{ °C}$	80	A
Repetitive peak collector current	I_{CRM}	t_p limited by $T_{vj \text{ op}}$		200	A
Gate-emitter peak voltage	V_{GES}			±20	V

Table 4 Characteristic values

Parameter	Symbol	Note or test condition	Values			Unit	
			Min.	Typ.	Max.		
Collector-emitter saturation voltage	$V_{CE\ sat}$	$I_C = 100\ A, V_{GE} = 15\ V$	$T_{vj} = 25\ ^\circ C$		1.50	1.80	V
			$T_{vj} = 125\ ^\circ C$		1.64		
			$T_{vj} = 175\ ^\circ C$		1.72		
Gate threshold voltage	V_{GETh}	$I_C = 2.5\ mA, V_{CE} = V_{GE}, T_{vj} = 25\ ^\circ C$		5.15	5.80	6.45	V
Gate charge	Q_G	$V_{GE} = \pm 15\ V, V_{CC} = 600\ V$			1.8		μC
Internal gate resistor	R_{Gint}	$T_{vj} = 25\ ^\circ C$			1.5		Ω
Input capacitance	C_{ies}	$f = 100\ kHz, T_{vj} = 25\ ^\circ C, V_{CE} = 25\ V, V_{GE} = 0\ V$			21.7		nF
Reverse transfer capacitance	C_{res}	$f = 100\ kHz, T_{vj} = 25\ ^\circ C, V_{CE} = 25\ V, V_{GE} = 0\ V$			0.076		nF
Collector-emitter cut-off current	I_{CES}	$V_{CE} = 1200\ V, V_{GE} = 0\ V$	$T_{vj} = 25\ ^\circ C$			0.0076	mA
Gate-emitter leakage current	I_{GES}	$V_{CE} = 0\ V, V_{GE} = 20\ V, T_{vj} = 25\ ^\circ C$				100	nA
Turn-on delay time (inductive load)	t_{don}	$I_C = 100\ A, V_{CC} = 600\ V, V_{GE} = \pm 15\ V, R_{Gon} = 0.68\ \Omega$	$T_{vj} = 25\ ^\circ C$		0.121		μs
			$T_{vj} = 125\ ^\circ C$		0.130		
			$T_{vj} = 175\ ^\circ C$		0.136		
Rise time (inductive load)	t_r	$I_C = 100\ A, V_{CC} = 600\ V, V_{GE} = \pm 15\ V, R_{Gon} = 0.68\ \Omega$	$T_{vj} = 25\ ^\circ C$		0.028		μs
			$T_{vj} = 125\ ^\circ C$		0.034		
			$T_{vj} = 175\ ^\circ C$		0.037		
Turn-off delay time (inductive load)	t_{doff}	$I_C = 100\ A, V_{CC} = 600\ V, V_{GE} = \pm 15\ V, R_{Goff} = 0.68\ \Omega$	$T_{vj} = 25\ ^\circ C$		0.276		μs
			$T_{vj} = 125\ ^\circ C$		0.356		
			$T_{vj} = 175\ ^\circ C$		0.395		
Fall time (inductive load)	t_f	$I_C = 100\ A, V_{CC} = 600\ V, V_{GE} = \pm 15\ V, R_{Goff} = 0.68\ \Omega$	$T_{vj} = 25\ ^\circ C$		0.081		μs
			$T_{vj} = 125\ ^\circ C$		0.157		
			$T_{vj} = 175\ ^\circ C$		0.219		
Turn-on energy loss per pulse	E_{on}	$I_C = 100\ A, V_{CC} = 600\ V, L_\sigma = 78\ nH, V_{GE} = \pm 15\ V, R_{Gon} = 0.68\ \Omega, di/dt = 2.01\ kA/\mu s (T_{vj} = 175\ ^\circ C)$	$T_{vj} = 25\ ^\circ C$		3.03		mJ
			$T_{vj} = 125\ ^\circ C$		4.74		
			$T_{vj} = 175\ ^\circ C$		6.3		
Turn-off energy loss per pulse	E_{off}	$I_C = 100\ A, V_{CC} = 600\ V, L_\sigma = 78\ nH, V_{GE} = \pm 15\ V, R_{Goff} = 0.68\ \Omega, dv/dt = 2510\ V/\mu s (T_{vj} = 175\ ^\circ C)$	$T_{vj} = 25\ ^\circ C$		6.57		mJ
			$T_{vj} = 125\ ^\circ C$		10.3		
			$T_{vj} = 175\ ^\circ C$		12.6		

(table continues...)

Table 4 (continued) Characteristic values

Parameter	Symbol	Note or test condition	Values			Unit
			Min.	Typ.	Max.	
SC data	I_{SC}	$V_{GE} \leq 15 \text{ V}, V_{CC} = 800 \text{ V}, V_{CEmax} = V_{CES} - L_{SCE} \cdot di/dt$	$t_p \leq 8 \mu\text{s}, T_{vj} = 150 \text{ }^\circ\text{C}$		370	A
			$t_p \leq 7 \mu\text{s}, T_{vj} = 175 \text{ }^\circ\text{C}$		350	
Thermal resistance, junction to heat sink	R_{thJH}	per IGBT, $\lambda_{grease} = 1 \text{ W}/(\text{m}\cdot\text{K})$		0.724		K/W
Temperature under switching conditions	$T_{vj op}$		-40		175	$^\circ\text{C}$

Note: $T_{vj op} > 150^\circ\text{C}$ is allowed for operation at overload conditions. For detailed specifications, please refer to AN 2018-14.

3 Diode, Inverter

Table 5 Maximum rated values

Parameter	Symbol	Note or test condition	Values	Unit	
Repetitive peak reverse voltage	V_{RRM}	$T_{vj} = 25 \text{ }^\circ\text{C}$	1200	V	
Continuous DC forward current	I_F		100	A	
Repetitive peak forward current	I_{FRM}	$t_p = 1 \text{ ms}$	200	A	
I^2t - value	I^2t	$t_p = 10 \text{ ms}, V_R = 0 \text{ V}$	$T_{vj} = 125 \text{ }^\circ\text{C}$	1450	A^2s
			$T_{vj} = 175 \text{ }^\circ\text{C}$	1300	

Table 6 Characteristic values

Parameter	Symbol	Note or test condition	Values			Unit	
			Min.	Typ.	Max.		
Forward voltage	V_F	$I_F = 100 \text{ A}, V_{GE} = 0 \text{ V}$	$T_{vj} = 25 \text{ }^\circ\text{C}$		1.72	2.10	V
			$T_{vj} = 125 \text{ }^\circ\text{C}$		1.59		
			$T_{vj} = 175 \text{ }^\circ\text{C}$		1.52		
Peak reverse recovery current	I_{RM}	$V_{CC} = 600 \text{ V}, I_F = 100 \text{ A}, V_{GE} = -15 \text{ V}, -di_F/dt = 2.01 \text{ kA}/\mu\text{s} (T_{vj} = 175 \text{ }^\circ\text{C})$	$T_{vj} = 25 \text{ }^\circ\text{C}$		159		A
			$T_{vj} = 125 \text{ }^\circ\text{C}$		169		
			$T_{vj} = 175 \text{ }^\circ\text{C}$		175		

(table continues...)

Table 6 (continued) Characteristic values

Parameter	Symbol	Note or test condition	Values			Unit
			Min.	Typ.	Max.	
Recovered charge	Q_r	$V_{CC} = 600\text{ V}, I_F = 100\text{ A},$ $V_{GE} = -15\text{ V}, -di_F/dt = 2.01$ $\text{kA}/\mu\text{s} (T_{vj} = 175\text{ }^\circ\text{C})$	$T_{vj} = 25\text{ }^\circ\text{C}$	8.3		μC
			$T_{vj} = 125\text{ }^\circ\text{C}$	15.1		
			$T_{vj} = 175\text{ }^\circ\text{C}$	19.5		
Reverse recovery energy	E_{rec}	$V_{CC} = 600\text{ V}, I_F = 100\text{ A},$ $V_{GE} = -15\text{ V}, -di_F/dt = 2.01$ $\text{kA}/\mu\text{s} (T_{vj} = 175\text{ }^\circ\text{C})$	$T_{vj} = 25\text{ }^\circ\text{C}$	3.49		mJ
			$T_{vj} = 125\text{ }^\circ\text{C}$	6.35		
			$T_{vj} = 175\text{ }^\circ\text{C}$	8.08		
Thermal resistance, junction to heat sink	R_{thJH}	per diode, $\lambda_{grease} = 1\text{ W}/(\text{m}\cdot\text{K})$		1.00		K/W
Temperature under switching conditions	$T_{vj\text{ op}}$		-40		175	$^\circ\text{C}$

Note: $T_{vj\text{ op}} > 150\text{ }^\circ\text{C}$ is allowed for operation at overload conditions. For detailed specifications, please refer to AN 2018-14.

4 NTC-Thermistor

Table 7 Characteristic values

Parameter	Symbol	Note or test condition	Values			Unit
			Min.	Typ.	Max.	
Rated resistance	R_{25}	$T_{NTC} = 25\text{ }^\circ\text{C}$		5		k Ω
Deviation of R_{100}	$\Delta R/R$	$T_{NTC} = 100\text{ }^\circ\text{C}, R_{100} = 493\text{ }\Omega$	-5		5	%
Power dissipation	P_{25}	$T_{NTC} = 25\text{ }^\circ\text{C}$			20	mW
B-value	$B_{25/50}$	$R_2 = R_{25} \exp[B_{25/50}(1/T_2 - 1/(298,15\text{ K}))]$		3375		K
B-value	$B_{25/80}$	$R_2 = R_{25} \exp[B_{25/80}(1/T_2 - 1/(298,15\text{ K}))]$		3411		K
B-value	$B_{25/100}$	$R_2 = R_{25} \exp[B_{25/100}(1/T_2 - 1/(298,15\text{ K}))]$		3433		K

Note: For an analytical description of the NTC characteristics please refer to AN2009-10, chapter 4.

5 Characteristics diagrams

Output characteristic (typical), IGBT, Inverter

$$I_C = f(V_{CE})$$

$$V_{GE} = 15 \text{ V}$$

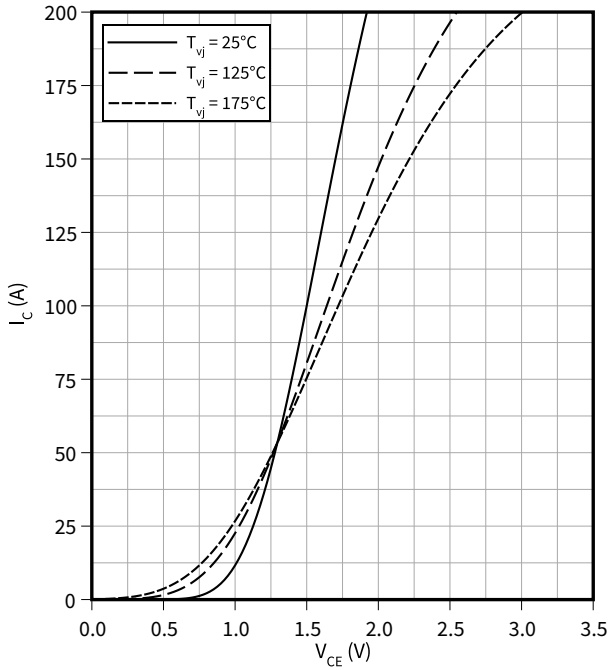

Output characteristic field (typical), IGBT, Inverter

$$I_C = f(V_{CE})$$

$$T_{vj} = 175 \text{ °C}$$

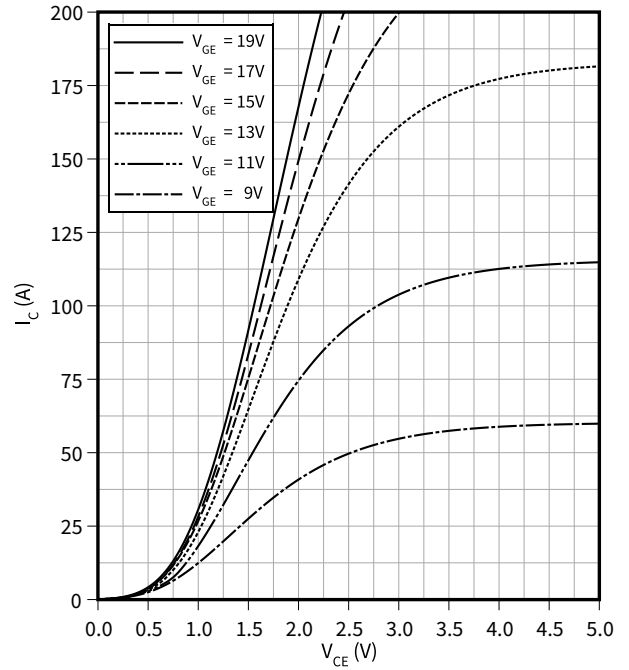

Transfer characteristic (typical), IGBT, Inverter

$$I_C = f(V_{GE})$$

$$V_{CE} = 20 \text{ V}$$

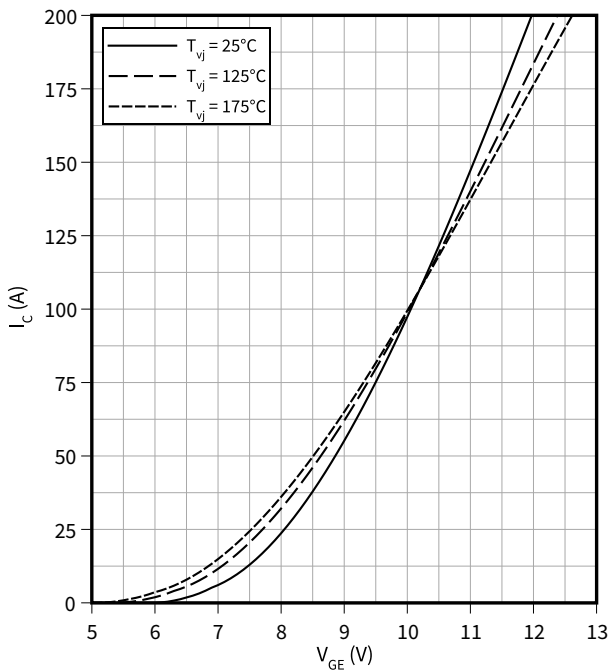

Gate charge characteristic (typical), IGBT, Inverter

$$V_{GE} = f(Q_G)$$

$$I_C = 100 \text{ A}, T_{vj} = 25 \text{ °C}$$

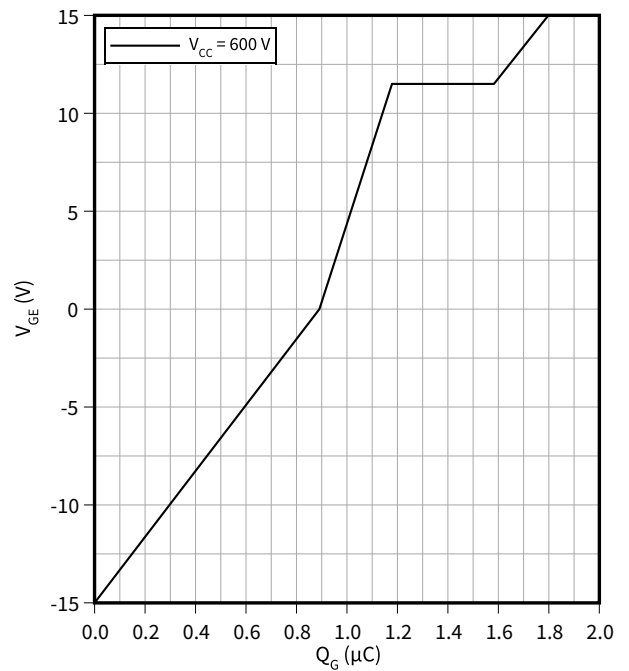

5 Characteristics diagrams

Capacity characteristic (typical), IGBT, Inverter

$C = f(V_{CE})$

$f = 100 \text{ kHz}, V_{GE} = 0 \text{ V}, T_{vj} = 25 \text{ }^\circ\text{C}$

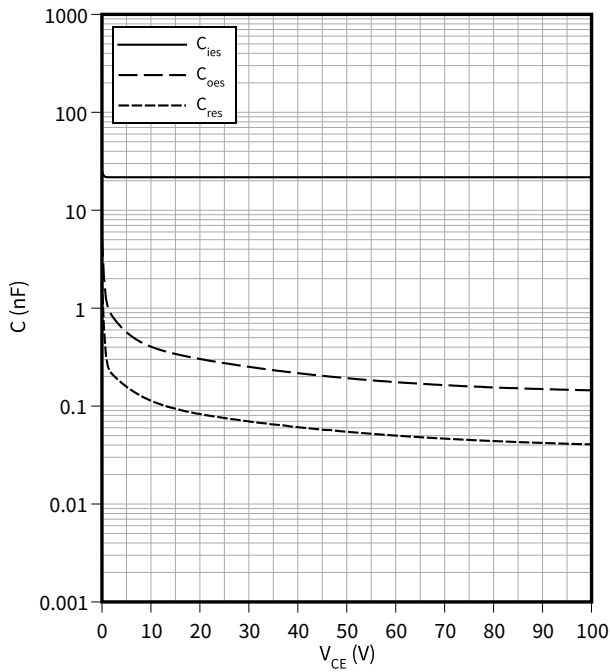

Switching times (typical), IGBT, Inverter

$t = f(I_C)$

$R_{Goff} = 0.68 \text{ } \Omega, R_{Gon} = 0.68 \text{ } \Omega, V_{GE} = \pm 15 \text{ V}, V_{CC} = 600 \text{ V}, T_{vj} = 175 \text{ }^\circ\text{C}$

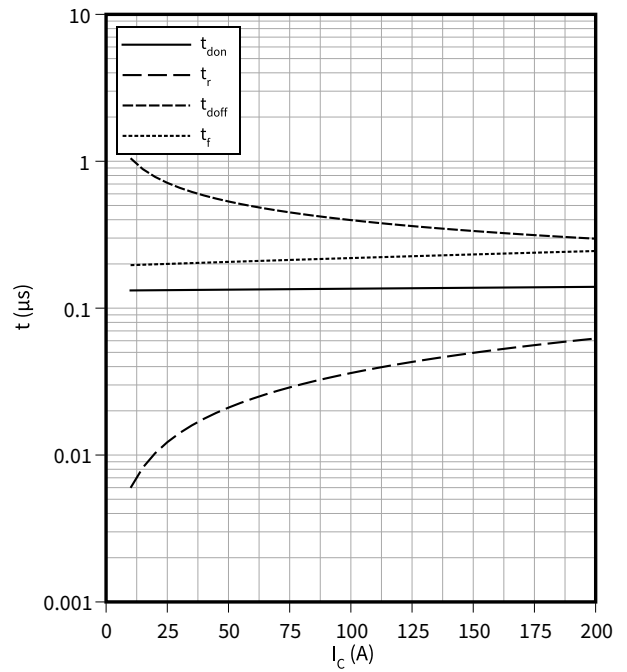

Switching times (typical), IGBT, Inverter

$t = f(R_G)$

$V_{GE} = \pm 15 \text{ V}, I_C = 100 \text{ A}, V_{CC} = 600 \text{ V}, T_{vj} = 175 \text{ }^\circ\text{C}$

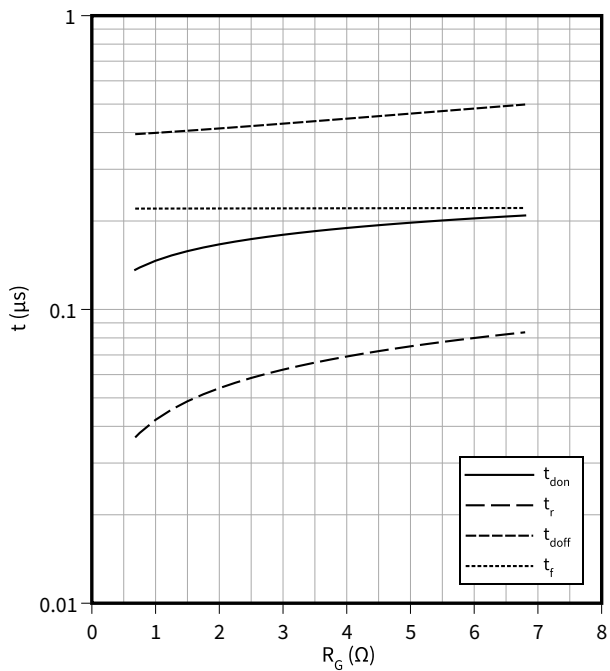

Voltage slope (typical), IGBT, Inverter

$dv/dt = f(R_G)$

$I_C = 100 \text{ A}, V_{CC} = 600 \text{ V}, V_{GE} = \pm 15 \text{ V}, T_{vj} = 25 \text{ }^\circ\text{C}$

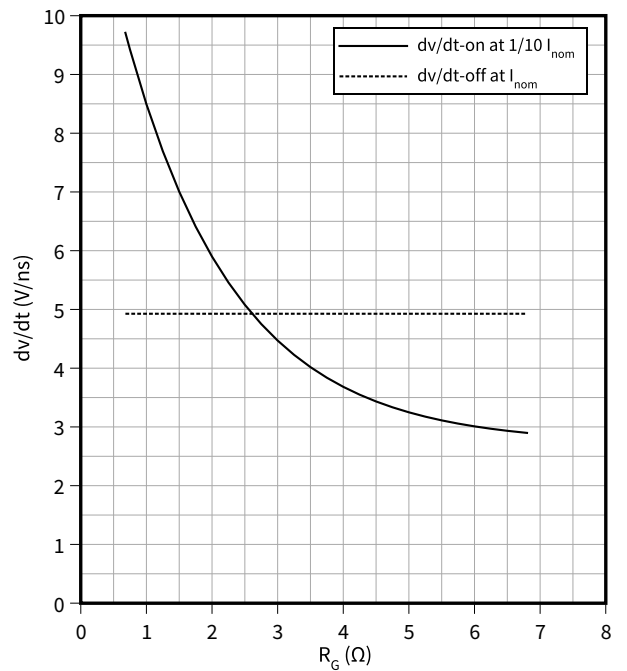

5 Characteristics diagrams

Switching losses (typical), IGBT, Inverter

$E = f(I_C)$

$R_{Goff} = 0.68 \Omega$, $R_{Gon} = 0.68 \Omega$, $V_{GE} = \pm 15 \text{ V}$, $V_{CC} = 600 \text{ V}$

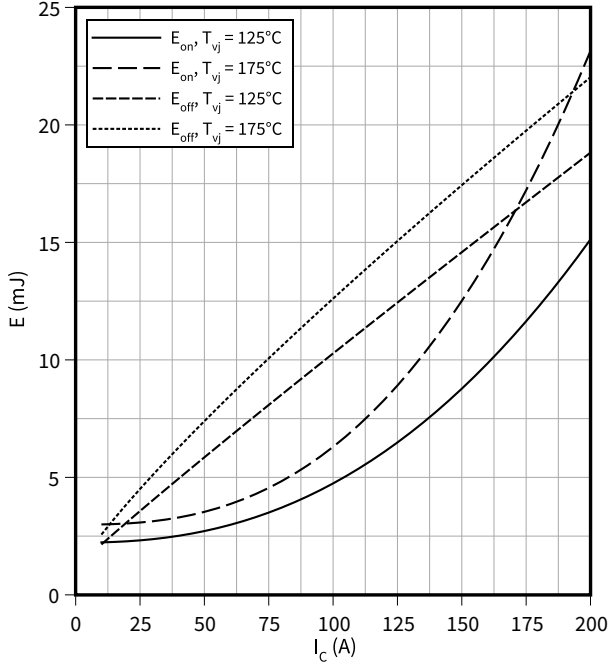

Switching losses (typical), IGBT, Inverter

$E = f(R_G)$

$V_{GE} = \pm 15 \text{ V}$, $I_C = 100 \text{ A}$, $V_{CC} = 600 \text{ V}$

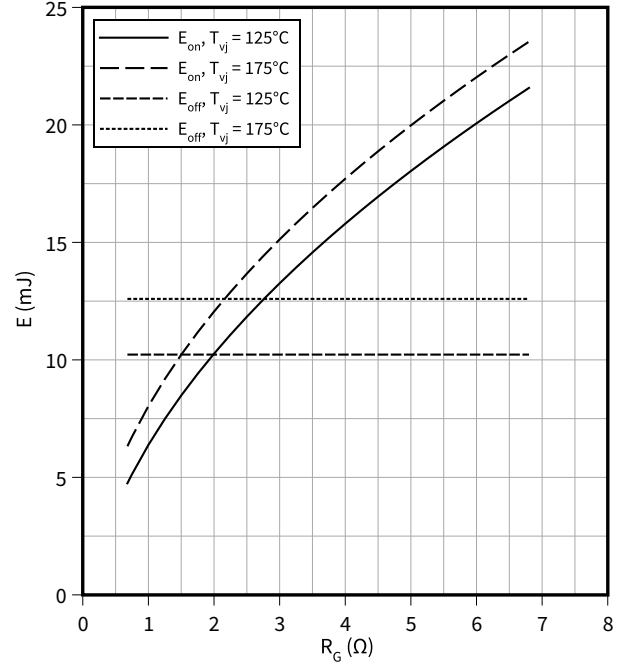

Reverse bias safe operating area (RBSOA), IGBT, Inverter

$I_C = f(V_{CE})$

$R_{Goff} = 0.68 \Omega$, $V_{GE} = \pm 15 \text{ V}$, $T_{vj} = 175 \text{ °C}$

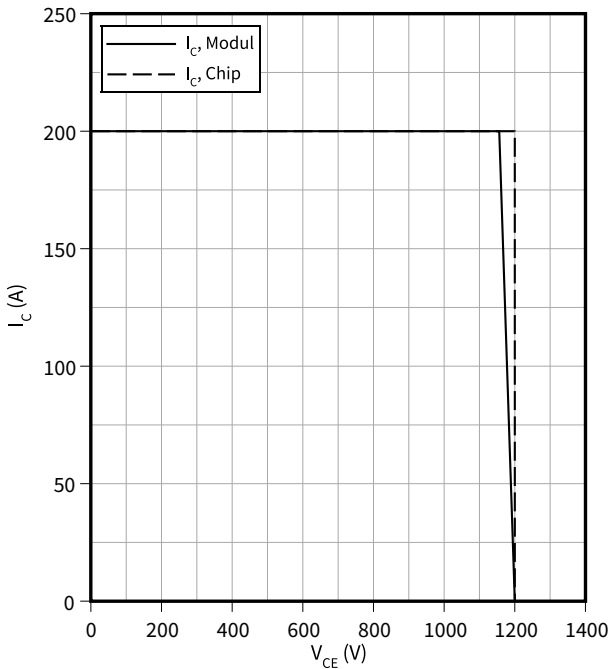

Transient thermal impedance, IGBT, Inverter

$Z_{th} = f(t)$

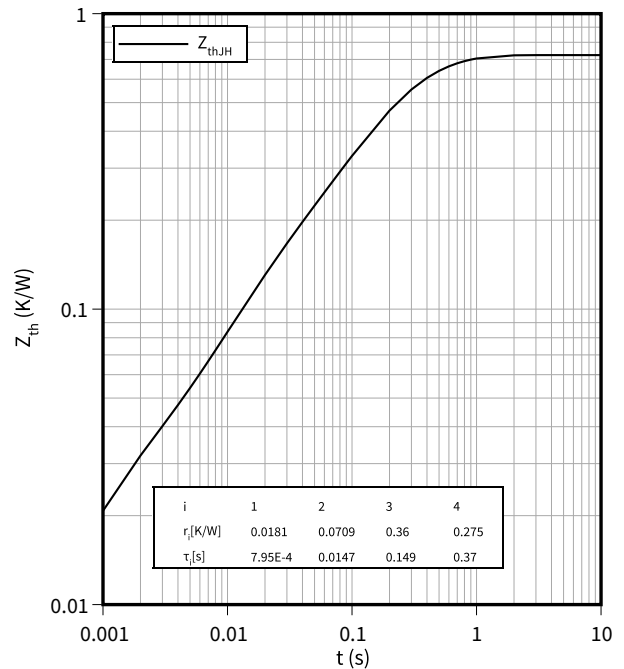

Forward characteristic (typical), Diode, Inverter

$I_F = f(V_F)$

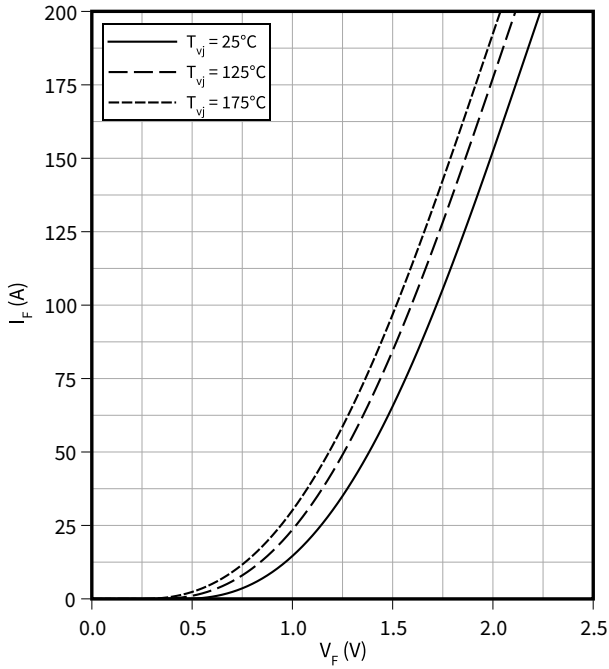

Switching losses (typical), Diode, Inverter

$E_{rec} = f(I_F)$

$R_{Gon} = 0.68 \Omega, V_{CC} = 600 \text{ V}$

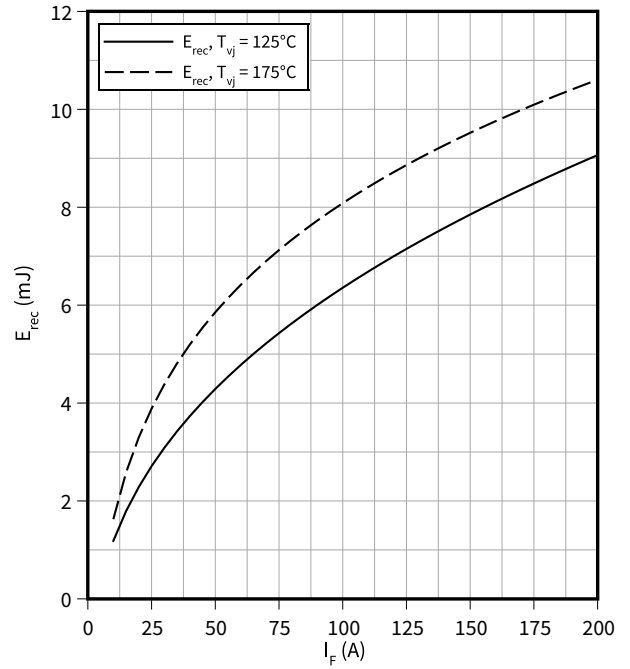

Switching losses (typical), Diode, Inverter

$E_{rec} = f(R_G)$

$I_F = 100 \text{ A}, V_{CC} = 600 \text{ V}$

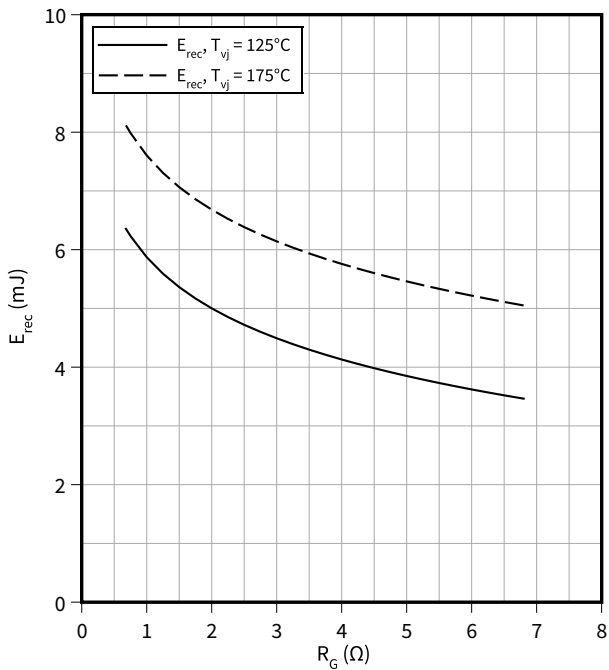

Transient thermal impedance, Diode, Inverter

$Z_{th} = f(t)$

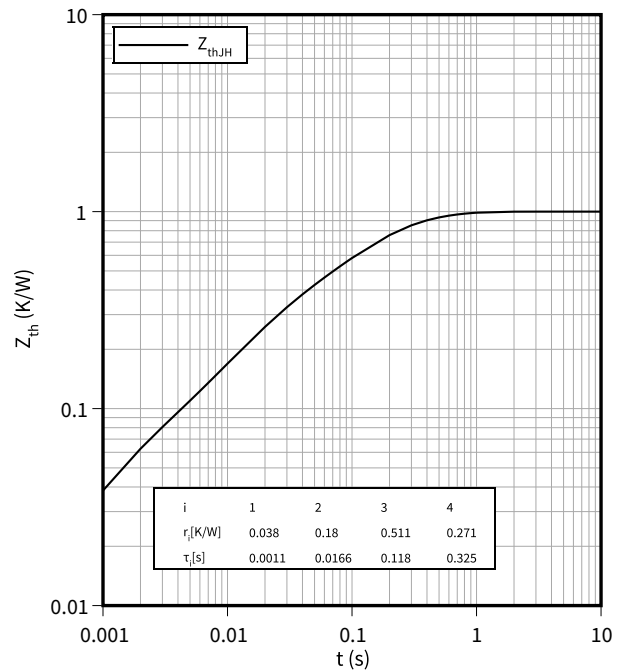

Temperature characteristic (typical), NTC-Thermistor

$R = f(T_{NTC})$

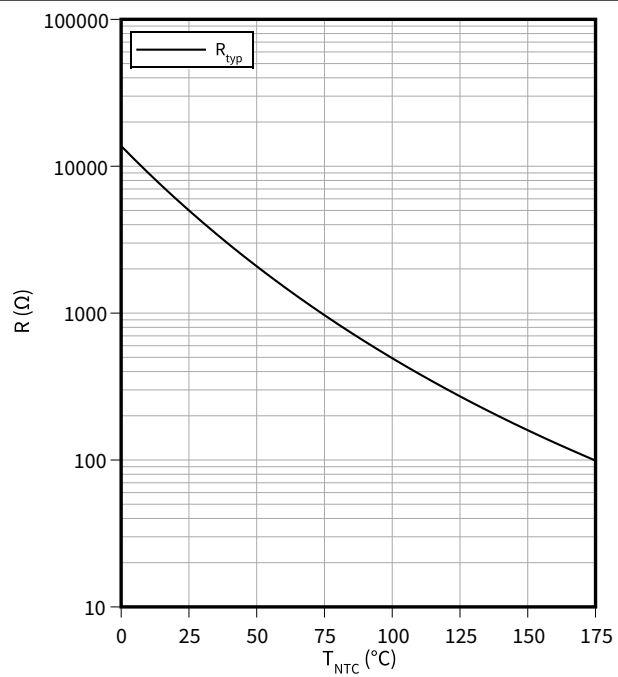

6 Circuit diagram

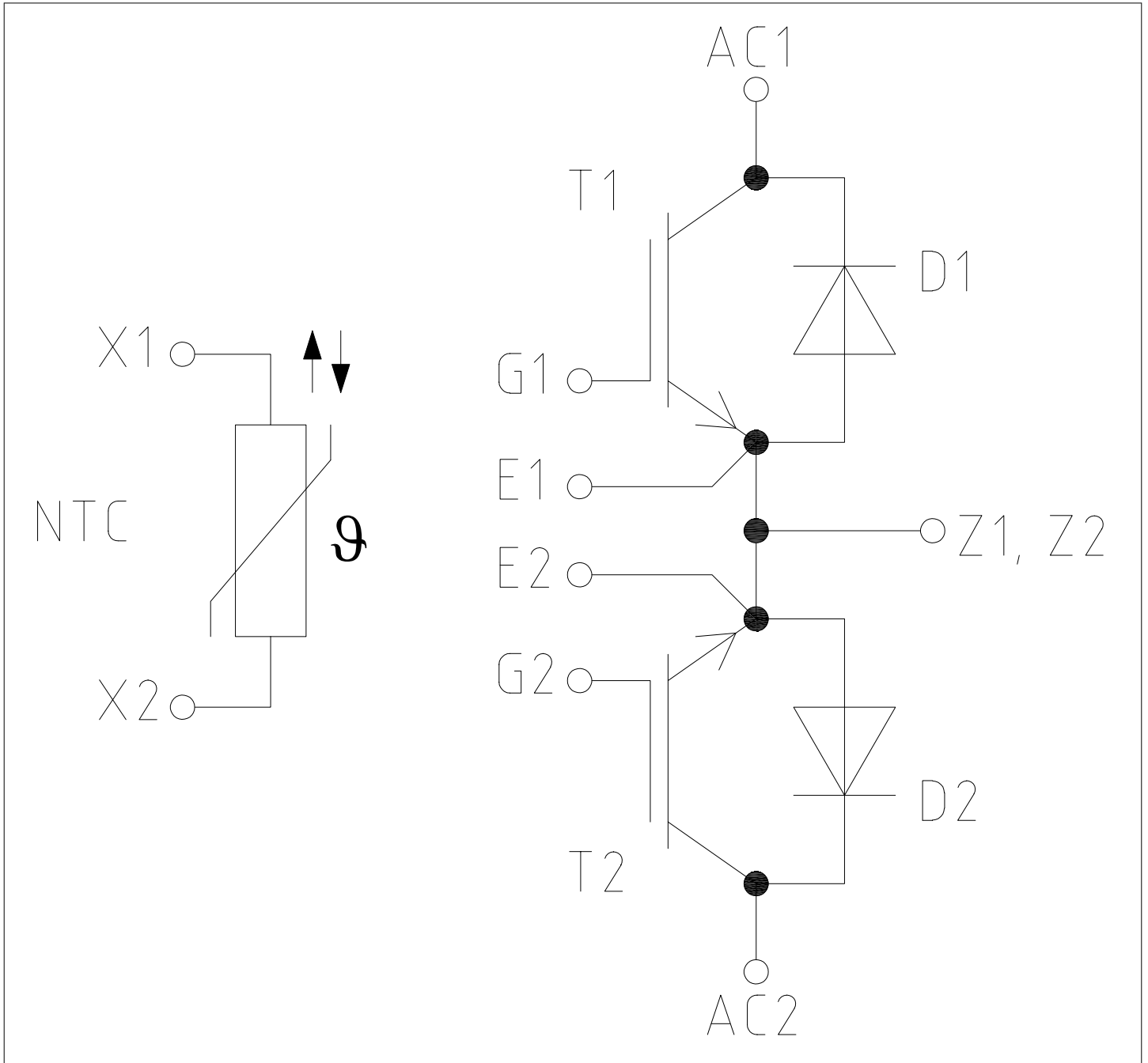

Figure 1

7 Package outlines

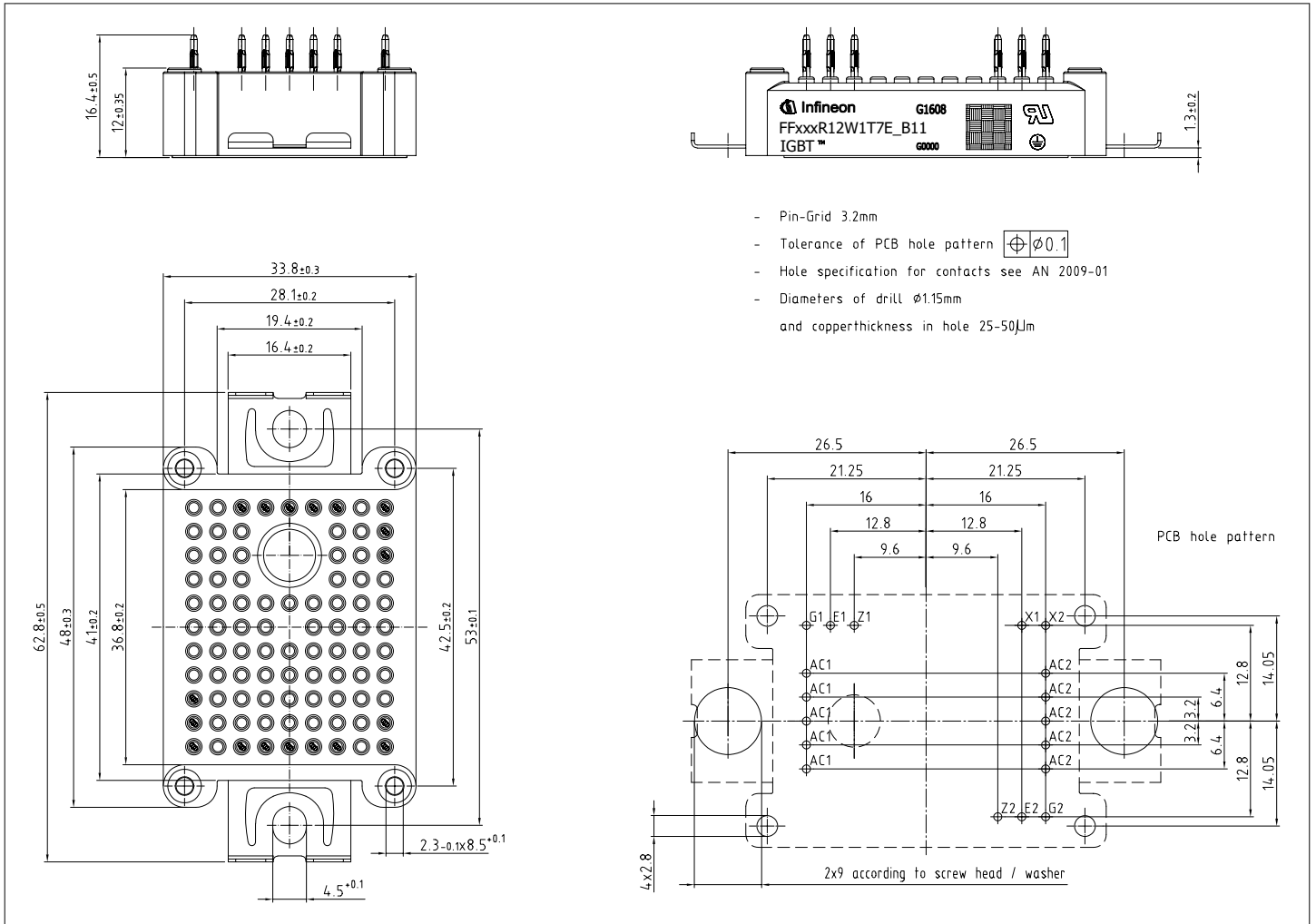

Figure 2

8 Module label code

Module label code			
Code format	Data Matrix	Barcode Code128	
Encoding	ASCII text	Code Set A	
Symbol size	16x16	23 digits	
Standard	IEC24720 and IEC16022	IEC8859-1	
Code content	Content	Digit	Example
	Module serial number	1 - 5	71549
	Module material number	6 - 11	142846
	Production order number	12 - 19	55054991
	Date code (production year)	20 - 21	15
	Date code (production week)	22 - 23	30
Example	 		
	71549142846550549911530		71549142846550549911530

Figure 3

Revision history

Document revision	Date of release	Description of changes
0.10	2023-06-01	Initial version
1.00	2023-08-28	Final datasheet

Trademarks

All referenced product or service names and trademarks are the property of their respective owners.

Edition 2023-08-28

Published by

Infineon Technologies AG

81726 Munich, Germany

© 2023 Infineon Technologies AG

All Rights Reserved.

Do you have a question about any aspect of this document?

Email: erratum@infineon.com

Document reference

IFX-ABB626-002

Important notice

The information given in this document shall in no event be regarded as a guarantee of conditions or characteristics ("Beschaffheitsgarantie").

With respect to any examples, hints or any typical values stated herein and/or any information regarding the application of the product, Infineon Technologies hereby disclaims any and all warranties and liabilities of any kind, including without limitation warranties of non-infringement of intellectual property rights of any third party.

In addition, any information given in this document is subject to customer's compliance with its obligations stated in this document and any applicable legal requirements, norms and standards concerning customer's products and any use of the product of Infineon Technologies in customer's applications.

The data contained in this document is exclusively intended for technically trained staff. It is the responsibility of customer's technical departments to evaluate the suitability of the product for the intended application and the completeness of the product information given in this document with respect to such application.

Warnings

Due to technical requirements products may contain dangerous substances. For information on the types in question please contact your nearest Infineon Technologies office.

Except as otherwise explicitly approved by Infineon Technologies in a written document signed by authorized representatives of Infineon Technologies, Infineon Technologies' products may not be used in any applications where a failure of the product or any consequences of the use thereof can reasonably be expected to result in personal injury.