

Part No. 1001312

Wi-Fi / BT / Zigbee or UWB Ceramic Antenna

2.4 GHz or 6.0 – 8.5 GHz

Supports: Wi-Fi applications, Bluetooth, Zigbee, WLAN, UWB

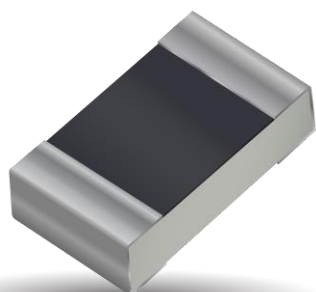

*UWB layout offered in Appendix 1

Ceramic Wi-Fi or UWB Ceramic Antenna

2400 – 2485 MHz;
 6.0 – 8.5 GHz

KEY BENEFITS

Stay-in-Tune

The ceramic antenna provides superior RF field containment, resulting in less interaction with surrounding components.

Quicker Time-to-Market

By optimizing antenna size, performance and emissions, customer and regulatory specifications are more easily met.

Environmental Compliance

Products are the latest RoHS version compliant.

APPLICATIONS

- Embedded design
- Cellular, Headsets, Tablets
- Gateway, Access Point
- Handheld
- Telematics
- Tracking
- Healthcare Applications (FDA Class I)
- M2M, Industrial devices
- Smart Grid
- OBD-II
- UWB

KYOCERA AVX ceramic antenna designed for Wi-Fi / BT and UWB applications exhibits the high efficiency in a small footprint and delivers the key needs to the device engineers for the higher functionality and better performance in a smaller and thinner designs. For further optimization to custom design and for support to integrate and test this antenna performance in your device, contact our Customer Support Team.

Real-World Performance and Implementation

Ceramic antennas may look alike on the outside, but the important difference is inside. Other antennas may contain simple PIFA or monopole designs that interact with their surroundings, complicating layout or changing performance with use position.

Layouts:

1001312-01: Single Band 2.4 GHz layout

1001312-04: UWB 6.0 - 8.5 GHz layout (Appendix 1)

Electrical Specifications

Typical performance on 55 x 25 mm PCB

Frequency	2400 – 2485 MHz	6.0 – 8.5 GHz
Peak Gain	1.88 dBi	Refer to Appendix 1
Average Efficiency	62%	
VSWR Match	1.8:1 max	
Feed Point Impedance	50 ohms unbalanced	
Polarization	Linear	
Power Handling	0.5 Watt CW	
Additional Resources	Download Application Note and Simulation Files	

Mechanical Specifications & Ordering Part Number

Ordering Part Number	1001312
Size (mm)	2.00 x 1.20 x 0.55
Mounting	SMT
Weight (grams)	0.003
Packaging	Tape & Reel, 1001312 – 5,000 pieces per reel
Demo Board	1001312-01 (2.400 - 2.485 GHz) 1001312-04 (UWB 6.000 - 8.500 GHz)
Additional Resources	Download DXF, Gerber and 3D FIT Files

2.4 GHz KYOCERA AVX Embedded Antenna Specifications
 KYOCERA AVX produces a wide variety of standard and custom antennas to meet user needs.

Antenna Dimensions

Typical antenna dimensions (mm)

Part Number	A (mm)	B (mm)	C (mm)
1001312	2.0 ± 0.3	1.2 ± 0.3	0.55 ± 0.2

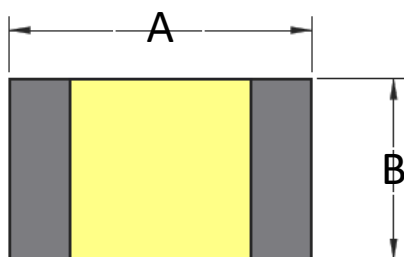
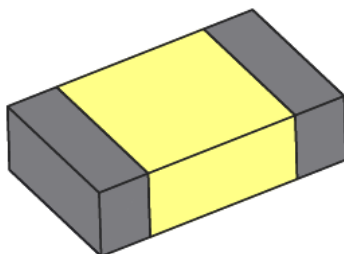

Top View

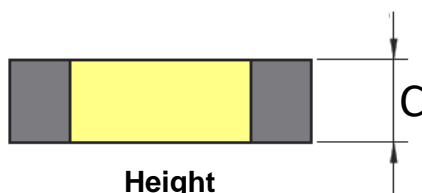

Height

Pin	Description
1	Feed
2	Ground

*Pin #1 and Pin #2 are interchangeable.

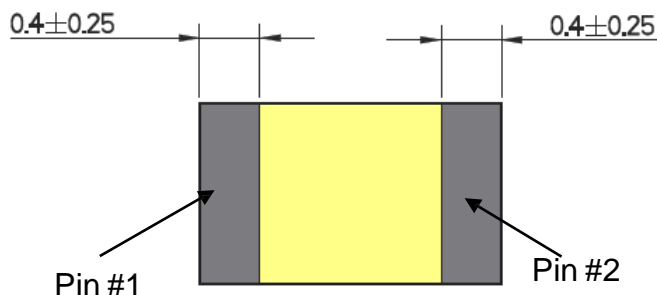

Bottom View

2.4 GHz KYOCERA AVX Embedded Antenna Specifications
 KYOCERA AVX produces a wide variety of standard and custom antennas to meet user needs.

VSWR, Efficiency Plots

Typical performance on 55 x 25 mm PCB

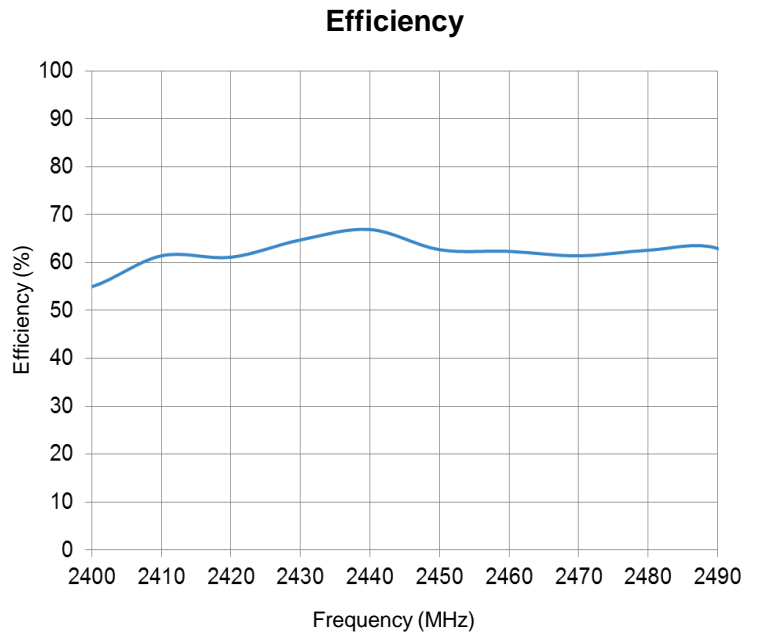
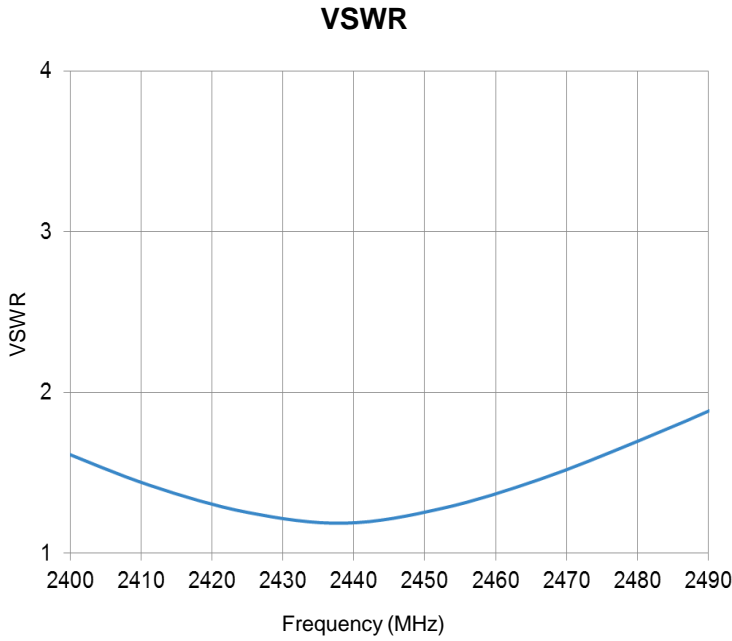

Antenna Radiation Patterns

Typical performance on 55 x 25 mm PCB
 Measured @ 2440 MHz

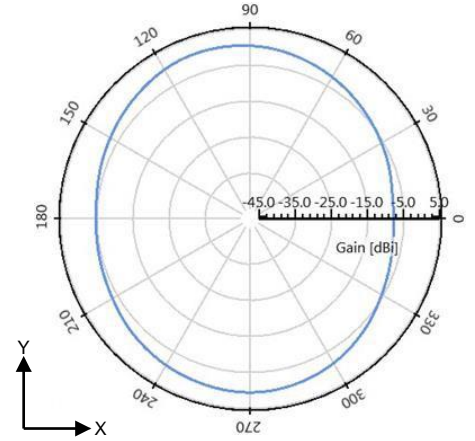
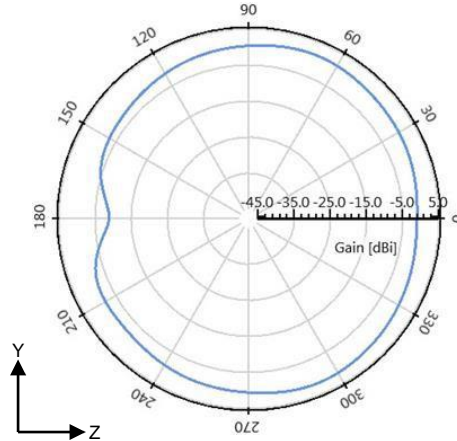
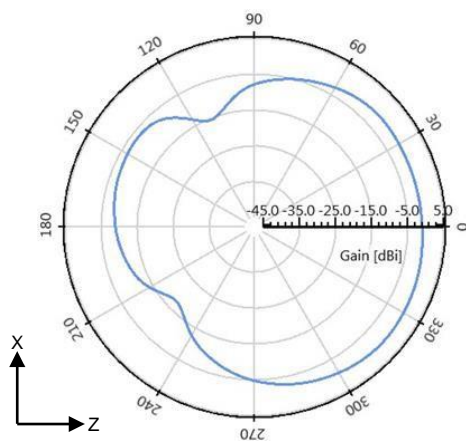

2.4 GHz KYOCERA AVX Embedded Antenna Specifications
 KYOCERA AVX produces a wide variety of standard and custom antennas to meet user needs.

Antenna Layout (1001312-01)

Typical layout dimensions (mm)

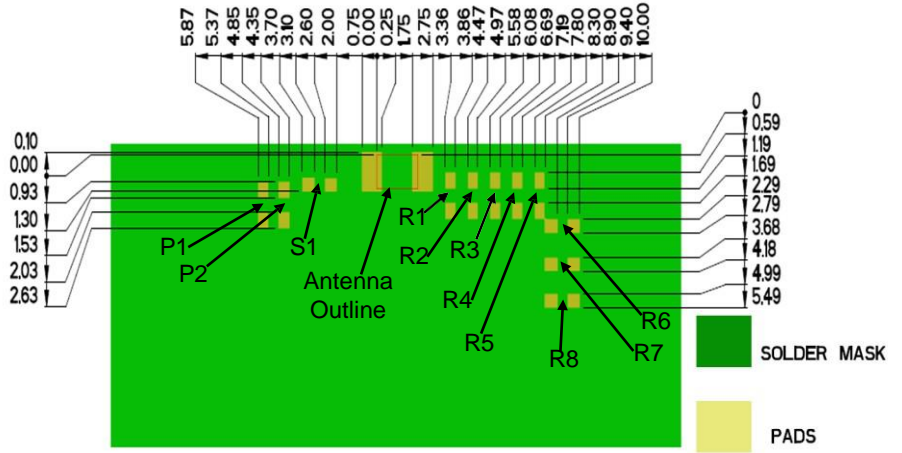
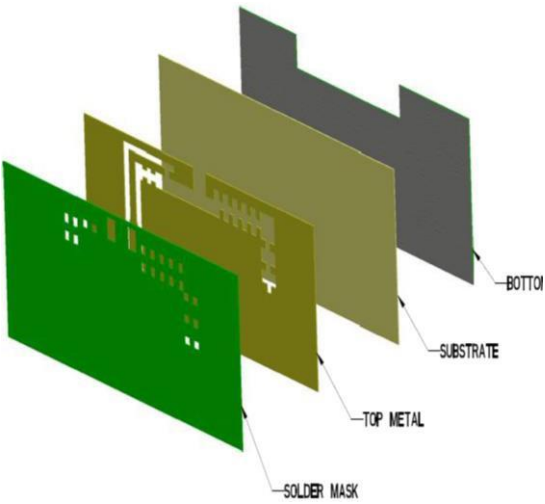

- Additional VIAS : Diam. 0.2mm to be placed around antenna, (no vias on transmission lines).
- Via holes must be covered by solder mask

Pin Descriptions

Pin#	Description
1	Feed
2	Ground

Matching Pi Network (Demo Board)

Component	Value	Tolerance
P1	4.7nH	±0.1nH
P2	DNI	N/A
S1	0Ω	N/A
R1	0Ω	N/A
R2 – R8	DNI	N/A

*Actual matching values depend on customer design

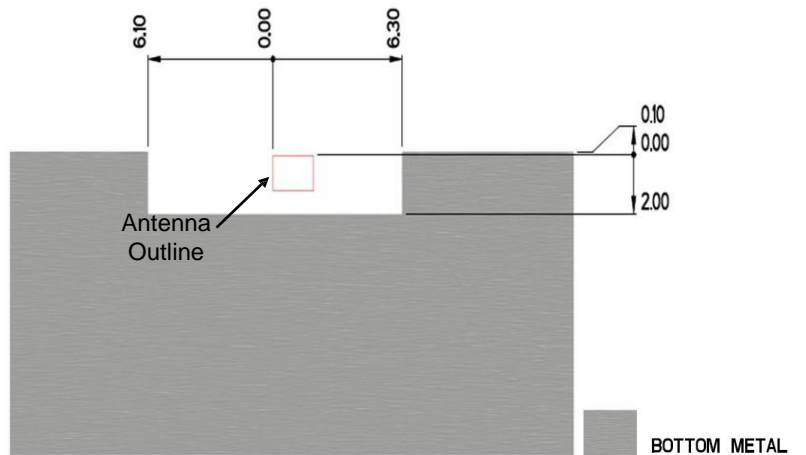
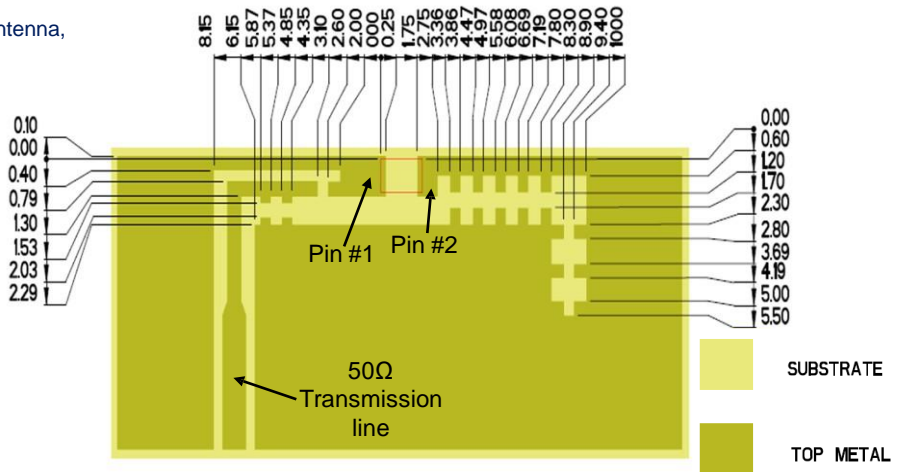
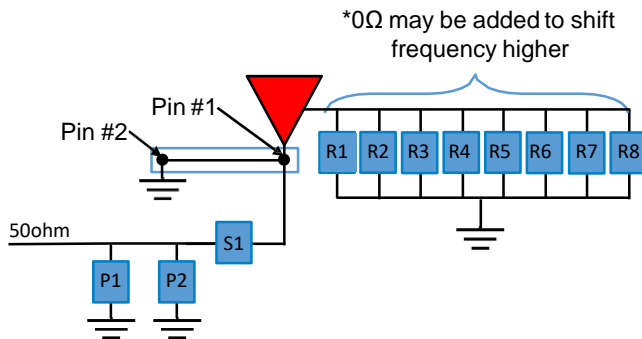

2.4 GHz KYOCERA AVX Embedded Antenna Specifications
 KYOCERA AVX produces a wide variety of standard and custom antennas to meet user needs.

Antenna Demo Board

Typical layout dimensions (mm)

Part Number	A	B	C
1001312-01	55.0	25.0	26.0

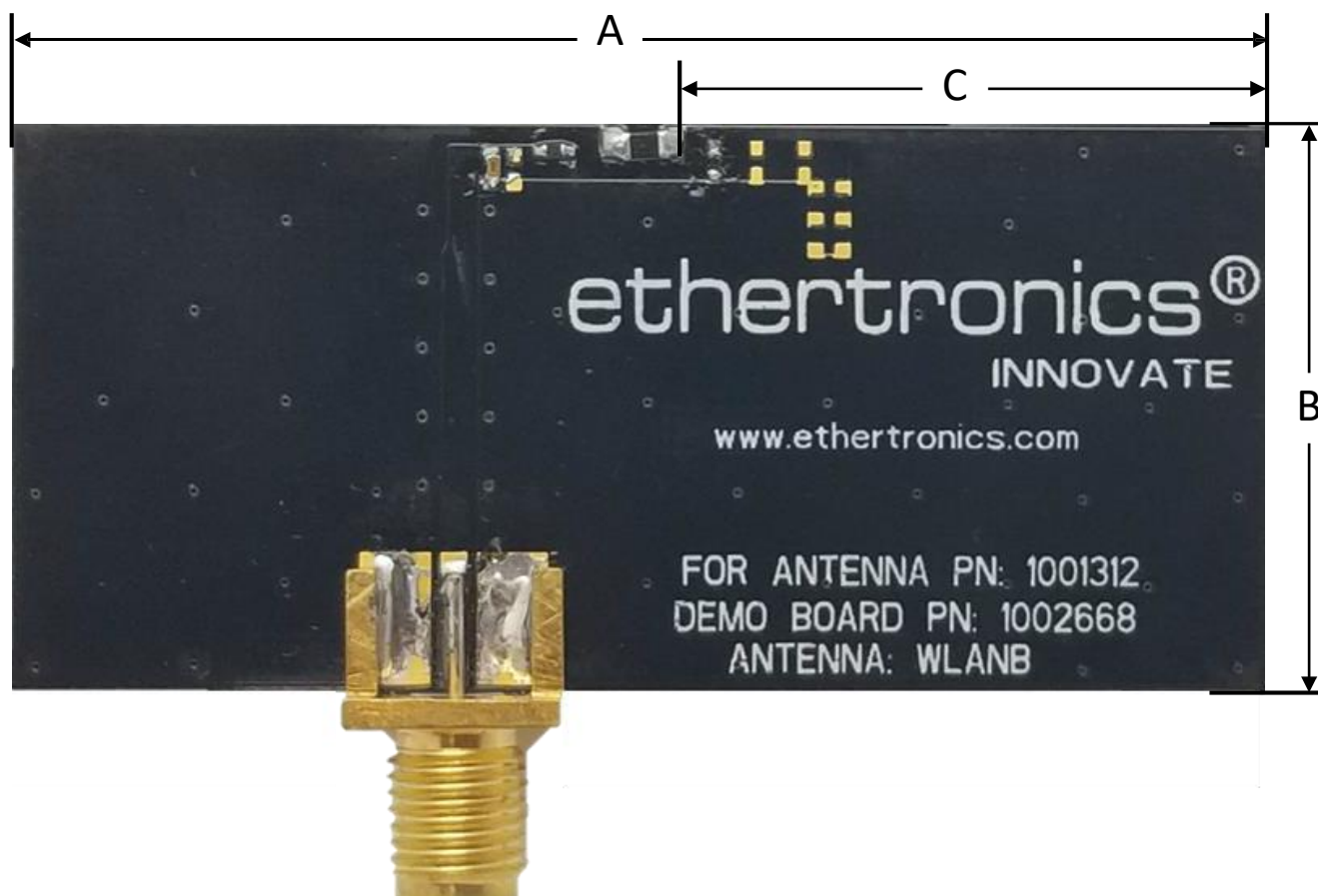

Appendix 1 UWB Ceramic KYOCERA AVX Embedded Antenna Specifications
 KYOCERA AVX produces a wide variety of standard and custom antennas to meet user needs.

Appendix 1

Appendix 1 gives instructions on how to achieve UWB performances through layout and impedance matching network.
(6.0 – 8.5 GHz)

Frequency (GHz)	6.0 – 8.5
Peak Gain	4.8 dBi
Average Efficiency	84%
VSWR Match	2.0:1 max
Feed Point Impedance	50 ohms unbalanced
Polarization	Linear
Power Handling	2 Watt CW

*Data shown above has Appendix 1 matching applied on 26.0 x 25.0 mm PCB,
 Using UWB 1001312-04 layout



Appendix 1 UWB Ceramic KYOCERA AVX Embedded Antenna Specifications
 KYOCERA AVX produces a wide variety of standard and custom antennas to meet user needs.

VSWR, Efficiency Plots

Typical performance on 26.0 x 25.0 mm PCB

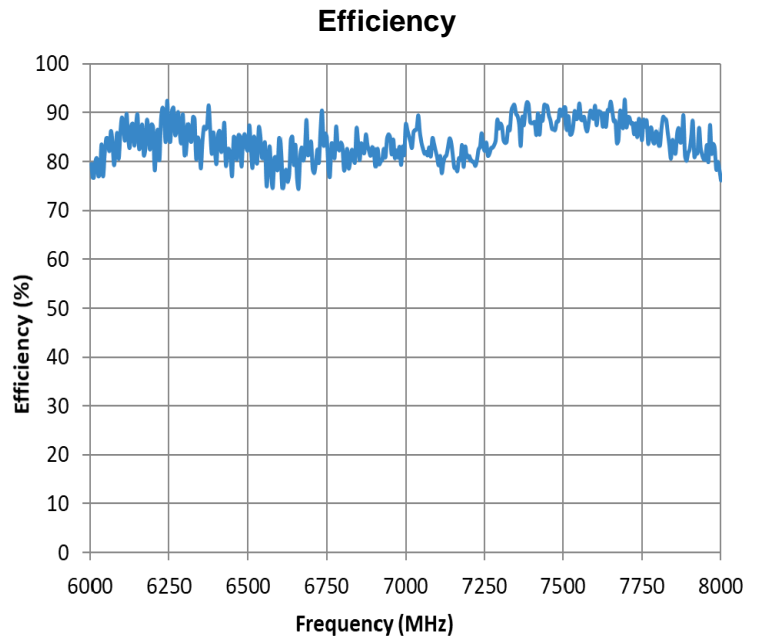
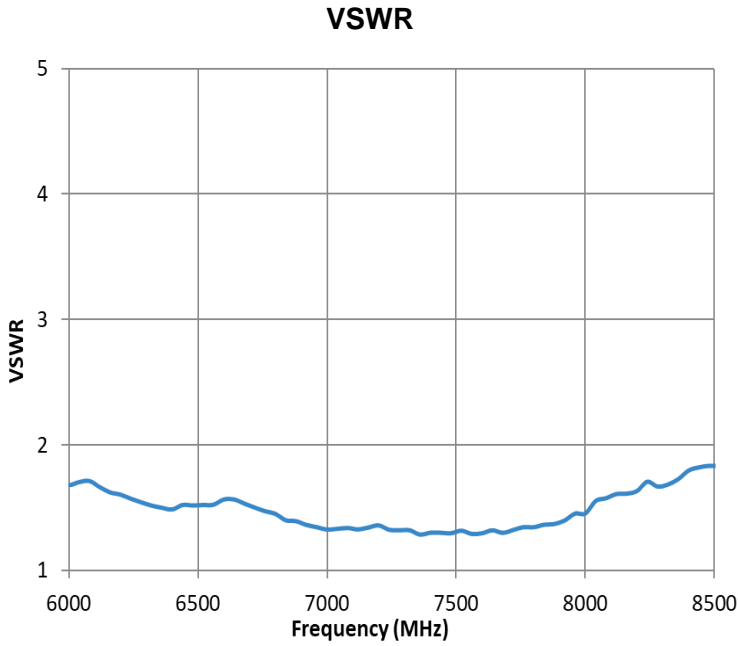

Antenna Radiation Patterns

Typical performance on 26.0 x 25.0 mm PCB
 Measured @ 6500, 7000, 8000 MHz

- 6500 MHz
- 7000 MHz
- 8000 MHz

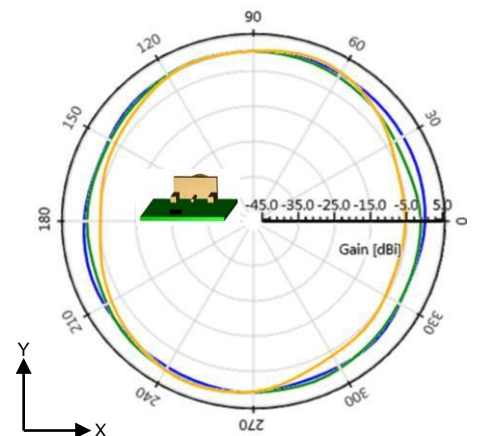
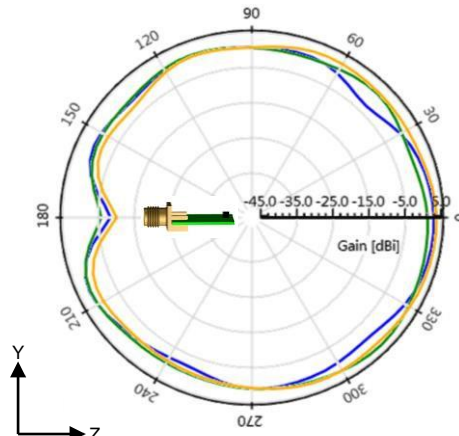
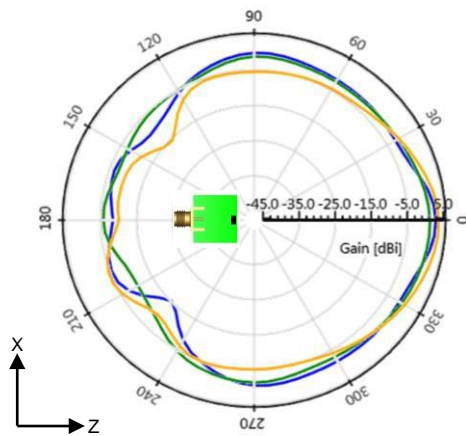
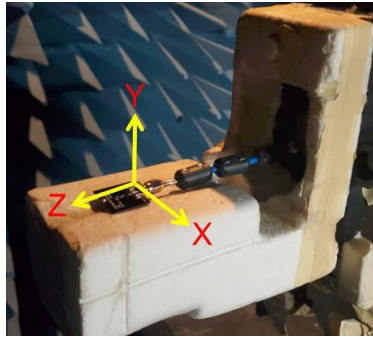

Appendix 1 UWB Ceramic KYOCERA AVX Embedded Antenna Specifications
 KYOCERA AVX produces a wide variety of standard and custom antennas to meet user needs.

Antenna Layout (1001312-04)

Typical layout dimensions (mm)

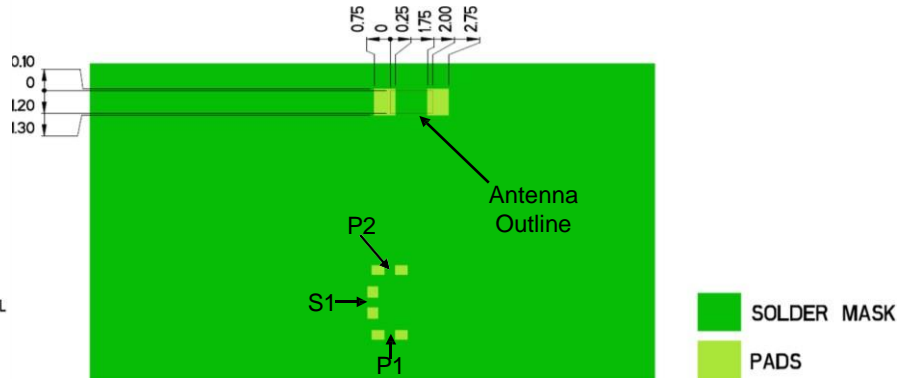
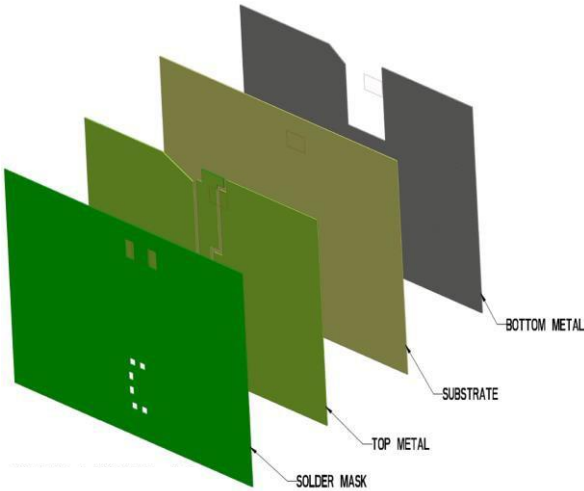

- Additional VIAS : Diam. 0.2mm to be placed around antenna, (no vias on transmission lines).
- Via holes must be covered by solder mask

Pin Descriptions

Pin#	Description
1	Feed
2	Ground

Matching Pi Network (Demo Board)

Component	Value	Tolerance
P1	DNI	N/A
S1	0Ω	N/A
P2	DNI	N/A

*Actual matching values depend on customer design

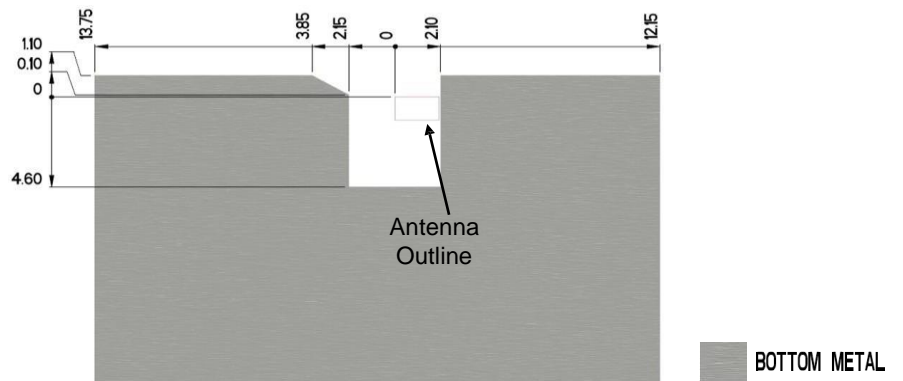
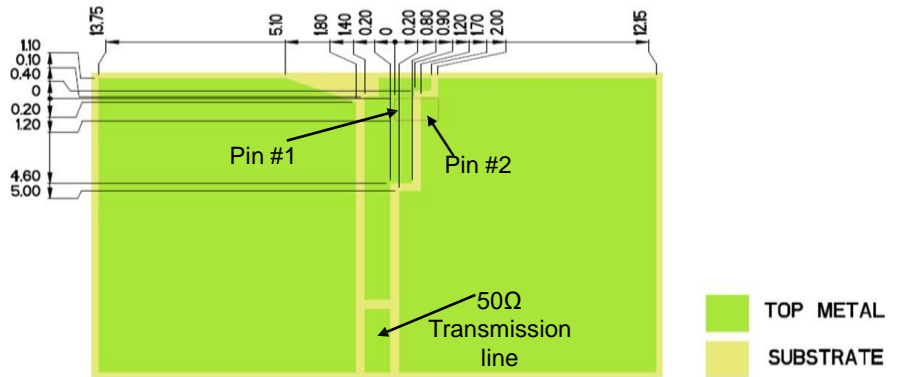
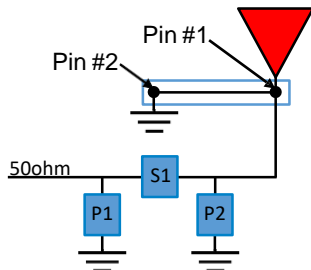

Appendix 1 UWB Ceramic KYOCERA AVX Embedded Antenna Specifications
 KYOCERA AVX produces a wide variety of standard and custom antennas to meet user needs.

Antenna Demo Board

Typical layout dimensions (mm)

Part Number	A	B	C
1001312-04	26.0 ± 0.25	25.0 ± 0.25	10.15

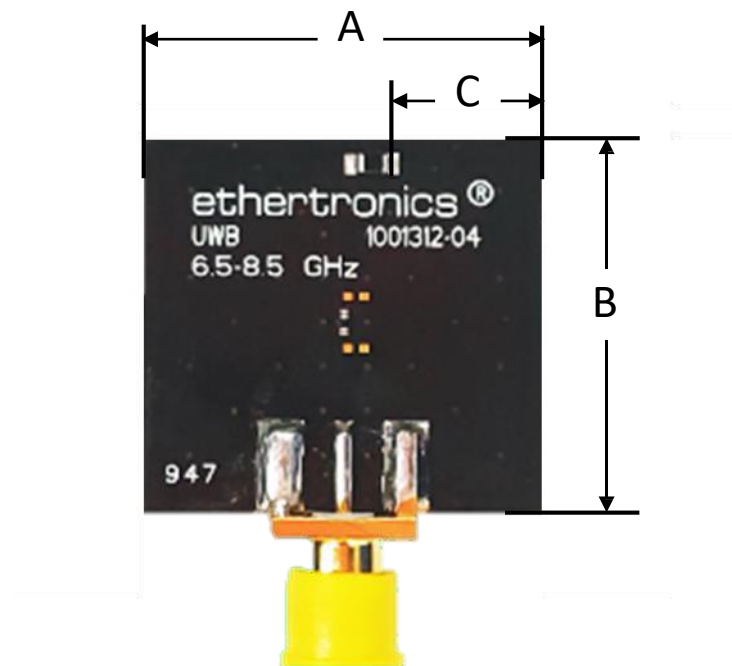

Appendix 1 UWB Ceramic KYOCERA AVX Embedded Antenna Specifications
KYOCERA AVX produces a wide variety of standard and custom antennas to meet user needs.

Additional Resources – 1001312-01 Wi-Fi / Bluetooth / Zigbee Ceramic Antenna

Simulation Files:

HFSS: [https://www.kyocera-avx.com/download/antennas/ansys-hfss/1001312_\(Antenna&EVB\)_HFSS_012224.zip](https://www.kyocera-avx.com/download/antennas/ansys-hfss/1001312_(Antenna&EVB)_HFSS_012224.zip)

CST: [https://www.kyocera-avx.com/download/antennas/CST/1001312_\(Antenna&EVBS\)_CST_040524.zip](https://www.kyocera-avx.com/download/antennas/CST/1001312_(Antenna&EVBS)_CST_040524.zip)

Application Note:

https://www.kyocera-avx.com/docs/techinfo/ApplicationNotes/Antenna-AppNotes/AVX-E_AppNote-1001312.pdf

3D FIT File:

https://www.kyocera-avx.com/download/antennas/ME-FIT/1001312_ME_fit.zip

DXF File:

https://www.kyocera-avx.com/download/antennas/3D-DXF/1001312-01_3D-DXF.zip

Gerber File:

https://www.kyocera-avx.com/download/antennas/GERBER/1001312-01_GERBERS.zip

Additional Resources – 1001312-04 UWB Ceramic Antenna

Simulation Files:

HFSS: [https://www.kyocera-avx.com/download/antennas/ansys-hfss/1001312_\(Antenna&EVB\)_HFSS_012224.zip](https://www.kyocera-avx.com/download/antennas/ansys-hfss/1001312_(Antenna&EVB)_HFSS_012224.zip)

CST: [https://www.kyocera-avx.com/download/antennas/CST/1001312_\(Antenna&EVBS\)_CST_040524.zip](https://www.kyocera-avx.com/download/antennas/CST/1001312_(Antenna&EVBS)_CST_040524.zip)

Application Note:

https://www.kyocera-avx.com/docs/techinfo/ApplicationNotes/Antenna-AppNotes/AVX-E_AppNote-1001312.pdf

3D FIT File:

https://www.kyocera-avx.com/download/antennas/ME-FIT/1001312_ME_fit.zip

DXF File:

https://www.kyocera-avx.com/download/antennas/3D-DXF/1001312-04_3D-DXF.zip

Gerber File:

https://www.kyocera-avx.com/download/antennas/GERBER/1001312-04_GERBERS.zip