

**CoolGaN™**  
**CoolGaN™ Transistor 100 V G3**

PG-TSON-6

**Features**

- Ultra fast switching and high efficiency
- Space saving and highly robust package
- No reverse recovery charge
- Ultra low gate charge and output charge
- Exposed die for top-side thermal excellence
- Moisture rating MSL1
- Industrial grade 3x5 package

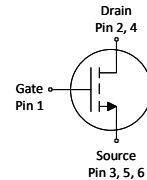
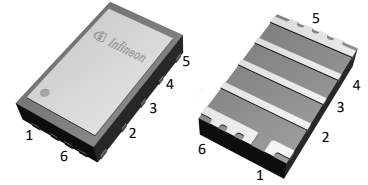

Top side is exposed silicon substrate, internally connected to source terminal. Not recommended to use as an electrical connection.

**Potential applications**

- Telecom & Datacenter 48V IBC
- Sync Rectification for AC-DC and DC-DC converters
- Robotics and drones
- Battery powered tools
- 48V servo drive
- e-Mobility, UAVs
- Class D Audio
- Solar & Energy storage systems
- Point of Load Converters

**Product validation**

Fully qualified according to JEDEC for Industrial Applications

**Table 1 Key performance parameters**

Parameter	Value	Unit
$V_{DS}$	100	V
$R_{DS(on)}$	2.4	mΩ
$I_D$	76	A
$Q_{oss}$	43	nC
$Q_G$	11	nC
$Q_{rr}$	0	nC

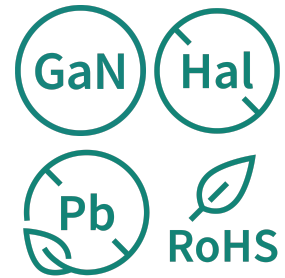

Type / Ordering code	Package	Marking	Related links
IGC033S10S1	PG-TSON-6	33SA1	see Appendix A

## Table of contents

Description .....	1
Maximum ratings .....	3
Recommended operating conditions .....	4
Thermal characteristics .....	5
Electrical Characteristics .....	6
Electrical characteristics diagrams .....	8
Package outlines .....	13
Appendix A .....	16
Revision history .....	17
Trademarks .....	17
Disclaimer .....	17

## 1 Maximum ratings

at  $T_j = 25\text{ °C}$ , unless otherwise specified. Stresses beyond max ratings may cause permanent damage to the device. For optimum lifetime and reliability, Infineon recommends operating conditions that do not continuously exceed 80 % of the maximum ratings stated (unless otherwise explicitly stated). For further information, contact your local Infineon sales office.

**Table 2 Maximum ratings**

Parameter	Symbol	Values			Unit	Note / Test condition
		Min.	Typ.	Max.		
Continuous drain-source voltage	$V_{DS}$	-	-	100	V	$V_{GS}=0\text{ V}$
Pulsed drain-source voltage <sup>1)</sup>	$V_{DS,pulse}$	-	-	120	V	$V_{GS}=0\text{ V}$ , 1 h total time
Continuous drain current	$I_D$	-	-	76 21	A	$V_{GS}=5\text{ V}$ , $T_C=25\text{ °C}$ $V_{GS}=5\text{ V}$ , $T_A=25\text{ °C}$ , $R_{thJA}=38\text{ °C/W}$ <sup>2)</sup>
Pulsed drain current <sup>3)</sup>	$I_{D,pulse}$	-	-	700 330	A	$T_j=25\text{ °C}$ $T_j=150\text{ °C}$
Pulsed gate-source voltage <sup>1)</sup>	$V_{GS}$	-6.5	-	6.5	V	Pulsed 100 h total time
Power dissipation	$P_{tot}$	-	-	45 3.3	W	$T_C=25\text{ °C}$ $T_A=25\text{ °C}$ , $R_{thJA}=38\text{ °C/W}$ <sup>2)</sup>
Storage temperature	$T_{stg}$	-55	-	150	°C	-
Junction temperature	$T_j$	-40	-	150	°C	-

<sup>1)</sup> Provided as measure of robustness under abnormal operating conditions and not recommended for normal operation.

<sup>2)</sup> Device on 4-layer FR4 PCB, vertical in still air.

<sup>3)</sup> Pulse current limited by transfer characteristic.

## 2 Recommended operating conditions

**Table 3 Recommended operating conditions**

Parameter	Symbol	Values			Unit	Note / Test condition
		Min.	Typ.	Max.		
Gate-source voltage	$V_{GS}$	-4.0	5.0	5.5	V	-

### 3 Thermal characteristics

**Table 4 Thermal characteristics**

Parameter	Symbol	Values			Unit	Note / Test condition
		Min.	Typ.	Max.		
Thermal resistance, junction - case, top	$R_{thJC}$	-	0.5	0.6	°C/W	-
Thermal resistance, junction - case, bottom	$R_{thJC}$	-	1.9	2.8	°C/W	-
Thermal resistance, junction - ambient 1s0p	$R_{thJA}$	-	60	-	°C/W	On 1 layer PCB, vertical in still air.
Thermal resistance, junction - ambient 2s2p	$R_{thJA}$	-	38	-	°C/W	With vias on 4 layer PCB, vertical in still air.

## 4 Electrical Characteristics

at  $T_j=25\text{ °C}$ , unless otherwise specified

**Table 5 Static characteristics**

Parameter	Symbol	Values			Unit	Note / Test condition
		Min.	Typ.	Max.		
Gate threshold voltage	$V_{GS(th)}$	1.2	1.9	2.9	V	$V_{DS}=V_{GS}$ , $I_D=8.0\text{ mA}$
Drain-source leakage current	$I_{DSS}$	-	0.3 6.0	1.5 50	$\mu\text{A}$	$V_{DS}=100\text{ V}$ , $V_{GS}=0\text{ V}$ , $T_j=25\text{ °C}$ $V_{DS}=100\text{ V}$ , $V_{GS}=0\text{ V}$ , $T_j=125\text{ °C}$
Gate-source leakage current	$I_{GSS}$	-	0.01 120 0.01	0.03 1100 0.04	$\mu\text{A}$	$V_{GS}=5\text{ V}$ , $T_j=25\text{ °C}$ $V_{GS}=-4\text{ V}$ , $T_j=25\text{ °C}$ $V_{GS}=5\text{ V}$ , $T_j=125\text{ °C}$ $V_{GS}=-4\text{ V}$ , $T_j=125\text{ °C}$
Drain-source on-state resistance	$R_{DS(on)}$	-	2.4	3.3	$\text{m}\Omega$	$V_{GS}=5\text{ V}$ , $I_D=20\text{ A}$
Gate resistance <sup>4)</sup>	$R_G$	-	0.5	-	$\Omega$	-

<sup>4)</sup> Defined by design. Not subject to production test.

**Table 6 Capacitance characteristics <sup>5)</sup>**

Parameter	Symbol	Values			Unit	Note / Test condition
		Min.	Typ.	Max.		
Input capacitance	$C_{iss}$	-	1200	1400	pF	$V_{GS}=0\text{ V}$ , $V_{DS}=50\text{ V}$ , $f=1\text{ MHz}$
Output capacitance	$C_{oss}$	-	540	590	pF	
Reverse transfer capacitance	$C_{rss}$	-	6.1	8.0	pF	

<sup>5)</sup> Defined by design. Not subject to production test.

**Table 7 Gate charge characteristics**

Parameter	Symbol	Values			Unit	Note / Test condition
		Min.	Typ.	Max.		
Gate to source charge	$Q_{gs}$	-	2.8	-	nC	$V_{DS}=50\text{ V}$ , $I_D=20\text{ A}$ , $V_{GS}=0\text{ to }5\text{ V}$
Gate charge at threshold	$Q_{g(th)}$	-	2.1	-	nC	
Gate to drain charge <sup>6)</sup>	$Q_{gd}$	-	2.6	-	nC	
Switching charge	$Q_{sw}$	-	3.3	-	nC	
Gate charge total <sup>6)</sup>	$Q_g$	-	11	14	nC	
Gate plateau voltage	$V_{plateau}$	-	2.6	-	V	
Output charge <sup>6)</sup>	$Q_{oss}$	-	43	47	nC	$V_{DS}=50\text{ V}$ , $V_{GS}=0\text{ V}$

<sup>6)</sup> Defined by design. Not subject to production test.

**Table 8 Reverse operation**

Parameter	Symbol	Values			Unit	Note / Test condition
		Min.	Typ.	Max.		
Reverse continuous current	$I_S$	-	-	16	A	$T_C=25\text{ °C}$
Pulsed current, reverse	$I_{S,pulse}$	-	-	304	A	
Source-Drain reverse voltage	$V_{SD}$	-	2.4 2.0	3.1 -	V	$V_{GS}=0\text{ V}, I_{S,pulse}=20\text{ A}, T_j=25\text{ °C}$ $V_{GS}=0\text{ V}, I_{S,pulse}=0.5\text{ A}, T_j=25\text{ °C}$
Reverse recovery charge <sup>7)</sup>	$Q_{rr}$	-	0	-	nC	$V_R=50\text{ V}, I_{S,pulse}=20\text{ A}, di_{S,pulse}/dt=100\text{ A}/\mu\text{s}$

<sup>7)</sup> Defined by design. Not subject to production test.

## 5 Electrical characteristics diagrams

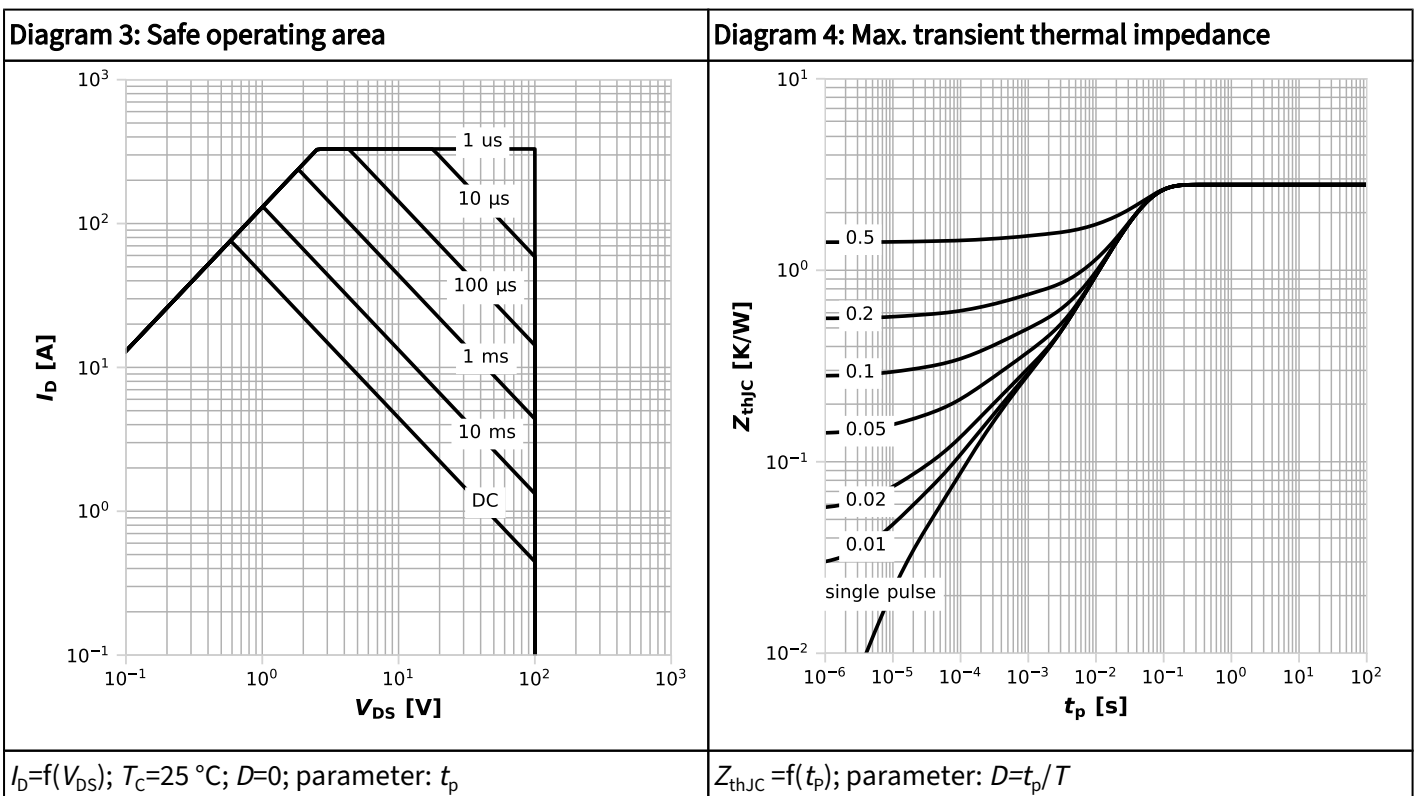
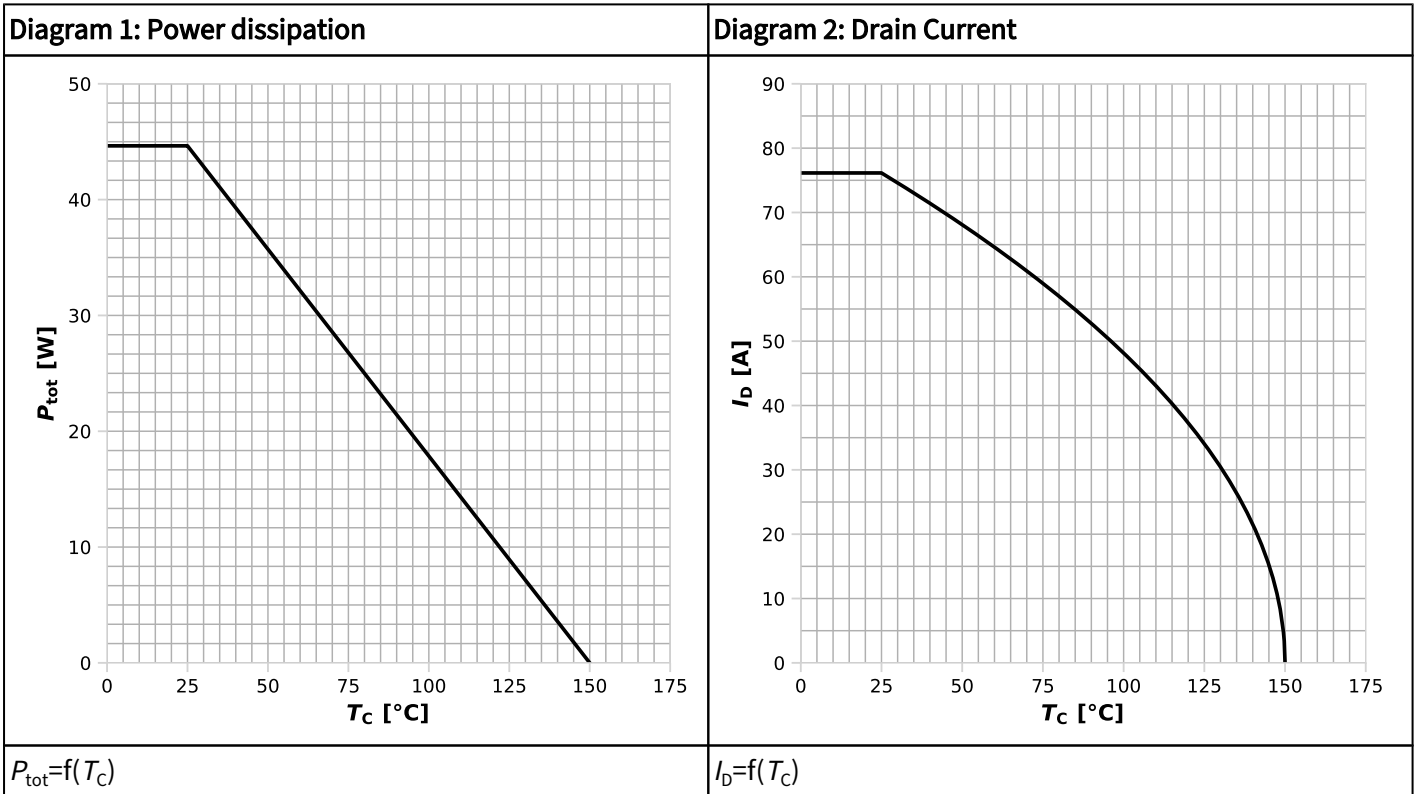
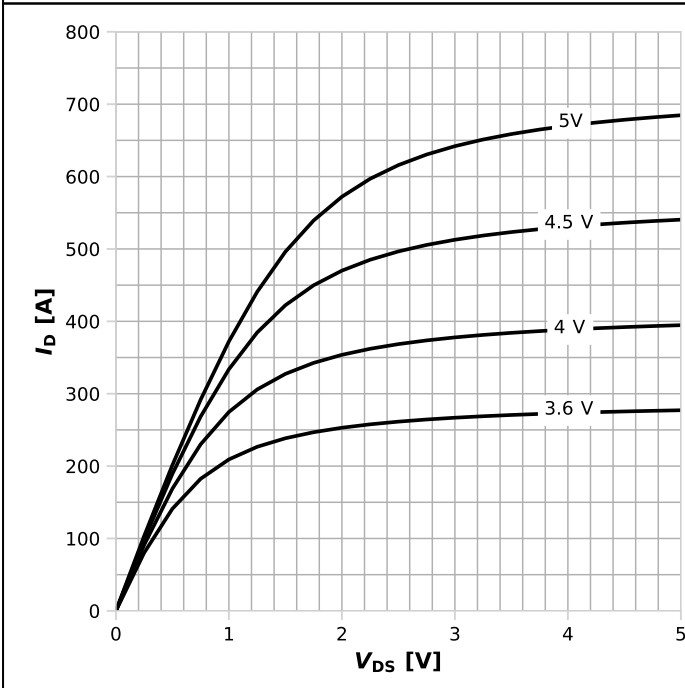

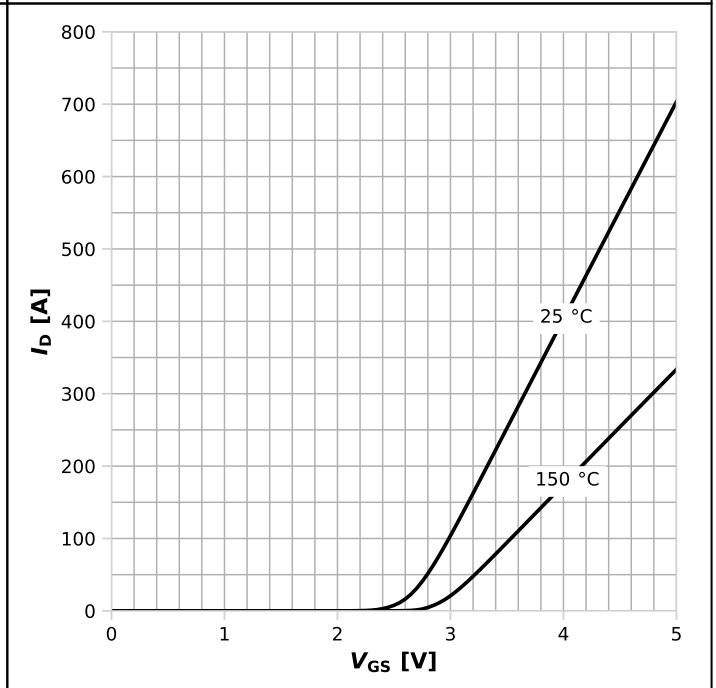

Diagram 5: Typ. output characteristics



$I_D = f(V_{DS}); T_j = 25\text{ }^\circ\text{C};$  parameter:  $V_{GS}$

Diagram 6: Typ. transfer characteristics



$I_D = f(V_{GS}); |V_{DS}| > 2|I_D|R_{DS(on)max};$  parameter:  $T_j$

Diagram 7: Typ. channel reverse characteristics

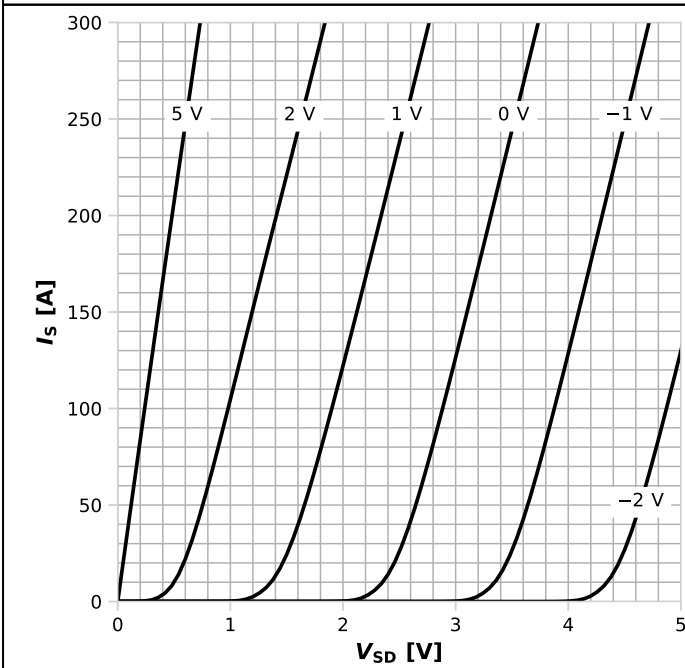

$I_S = f(V_{SD}); T_j = 25\text{ }^\circ\text{C};$  parameter:  $V_{GS}$

Diagram 8: Typ. channel reverse characteristics

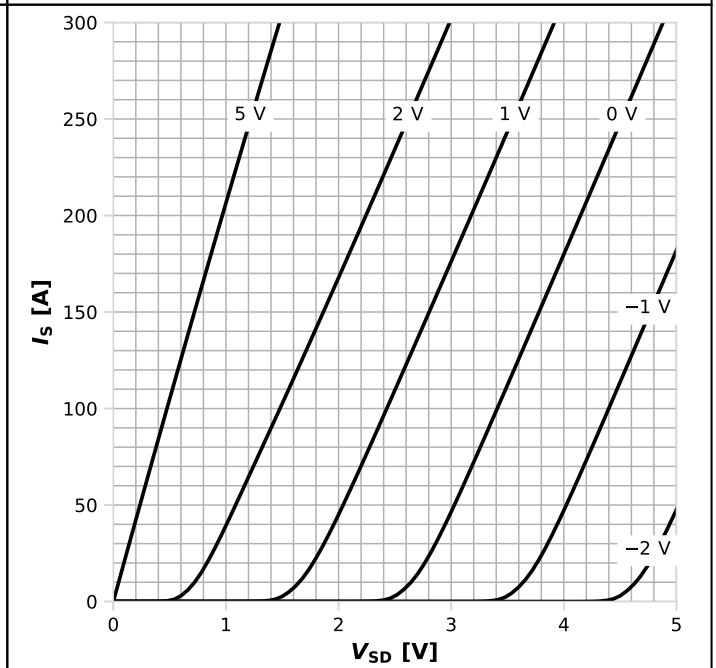

$I_S = f(V_{SD}); T_j = 125\text{ }^\circ\text{C};$  parameter:  $V_{GS}$

Diagram 9: Typ. drain-source on-state resistance

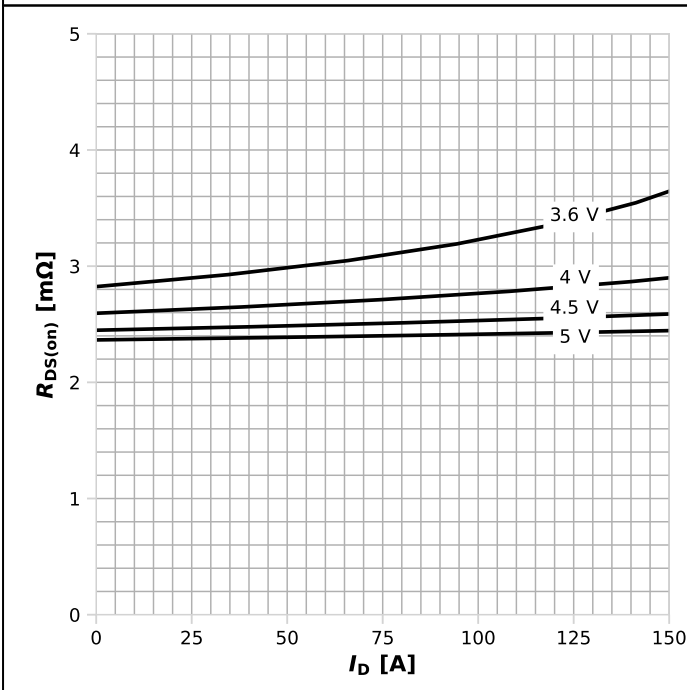

$R_{DS(on)}=f(I_D); T_j=25\text{ }^\circ\text{C}; \text{parameter: } V_{GS}$

Diagram 10: Typ. Drain-source on-state resistance

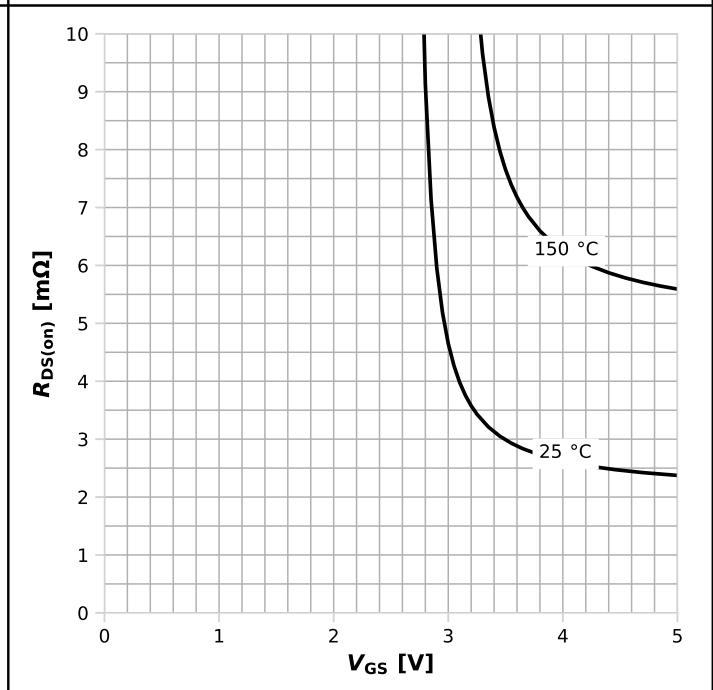

$R_{DS(on)}=f(V_{GS}); I_D=20\text{ A}; \text{parameter: } T_j$

Diagram 11: Drain-source on-state resistance

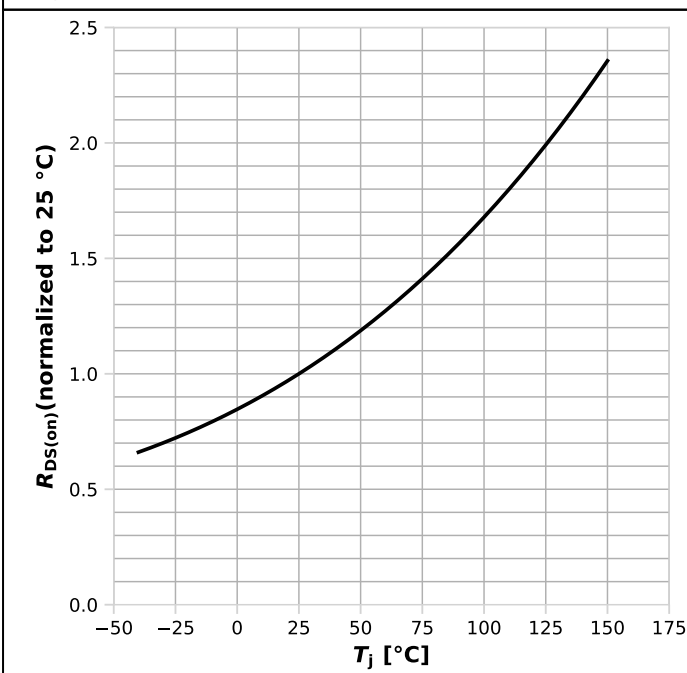

$R_{DS(on)}=f(T_j); I_D=20\text{ A}, V_{GS}=5\text{ V}$

Diagram 12: Typ. gate threshold voltage

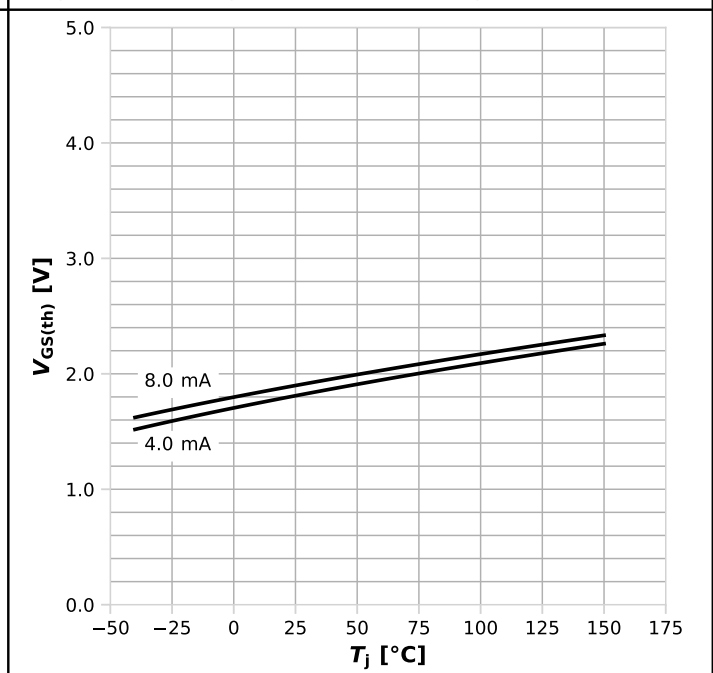

$V_{GS(th)}=f(T_j), V_{GS}=V_{DS}; \text{parameter: } I_D$

Diagram 13: Typ. capacitances

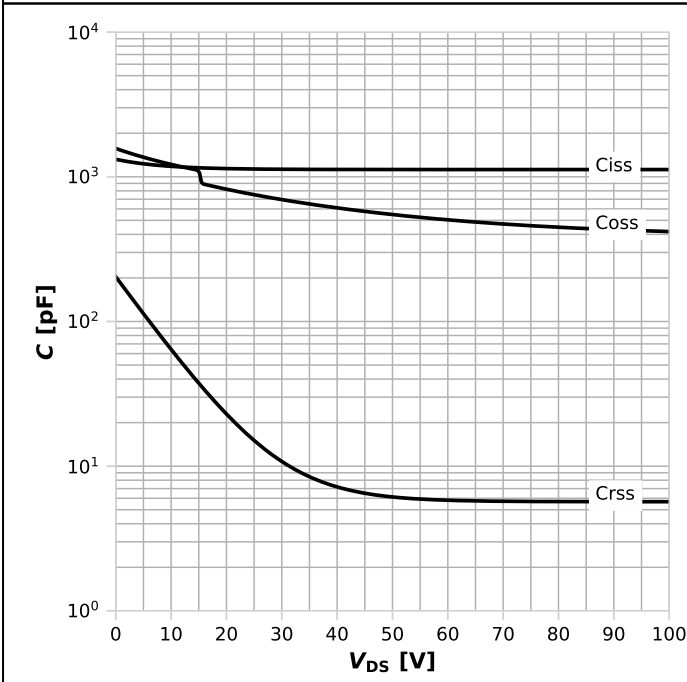

$C=f(V_{DS}); V_{GS}=0\text{ V}$

Diagram 14 Typ. gate charge

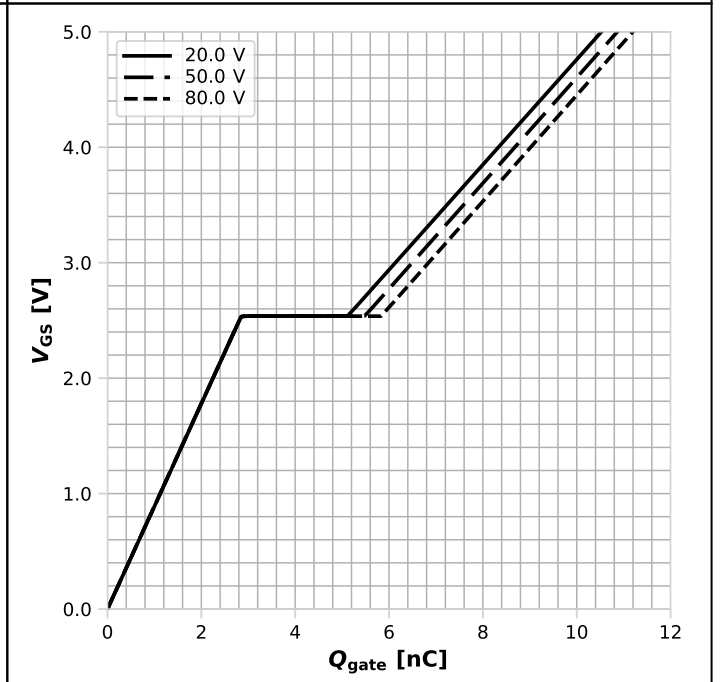

$V_{GS}=f(Q_{gate}); I_D=20\text{ A pulsed}; \text{parameter: } V_{DS}$

Diagram 15: Typ. output charge

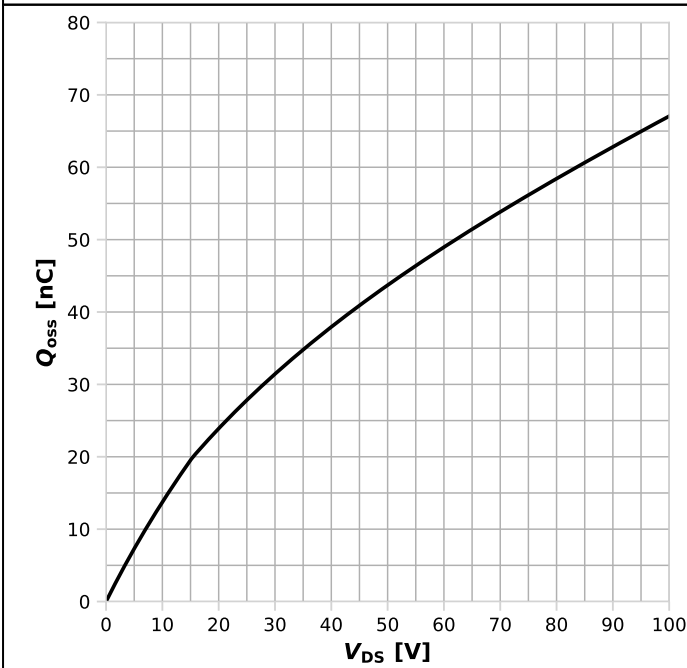

$Q_{oss}=f(V_{DS}), V_{GS}=0\text{ V}$

Diagram 16: Typ. Coss stored Energy

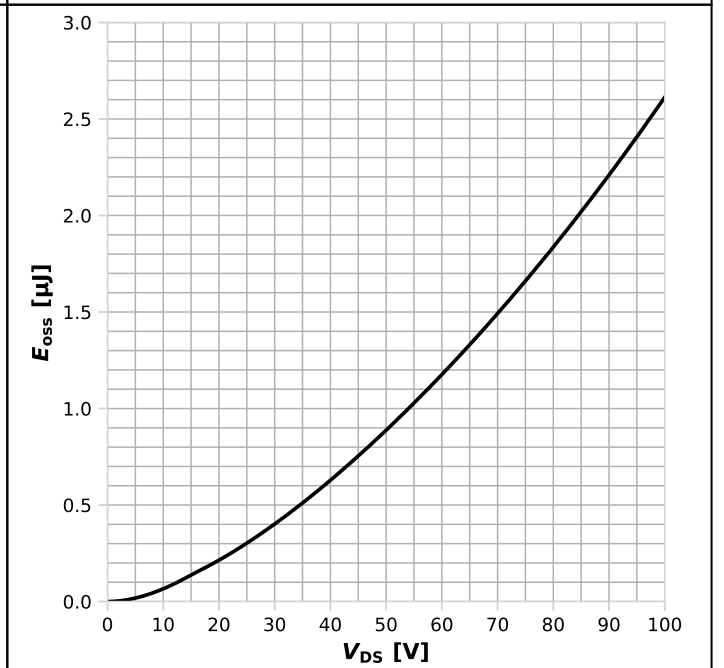

$E_{oss}=f(V_{DS}), V_{GS}=0\text{ V}$

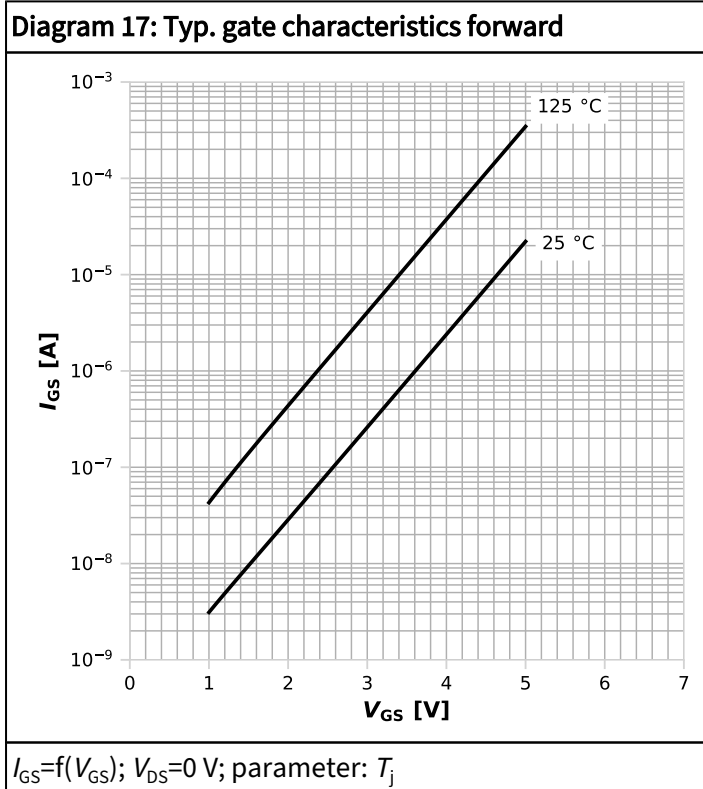

## 6 Package outlines

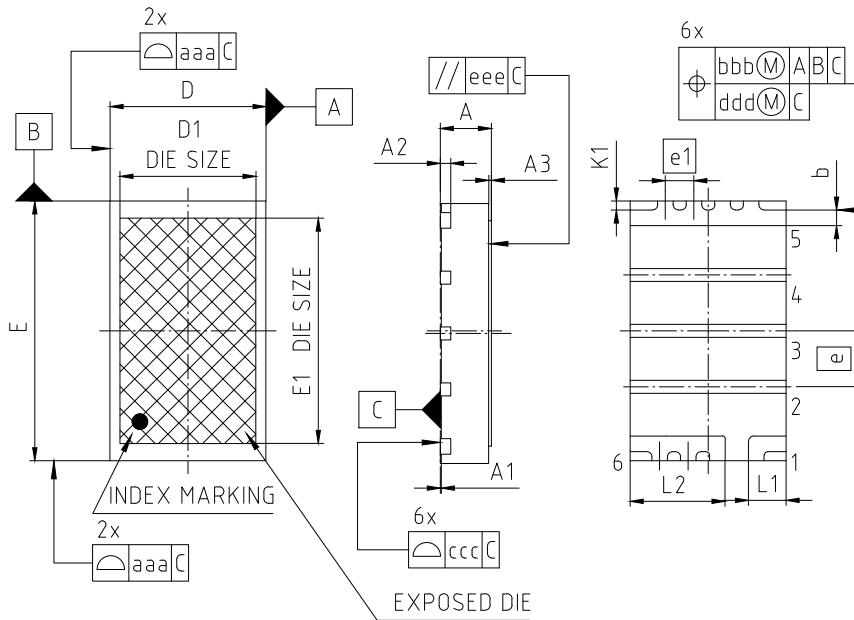

PACKAGE - GROUP NUMBER: <b>PG-TSON-6-U01</b>		
DIMENSIONS	MILLIMETERS	
	MIN.	MAX.
A	-	1.032
A1	-	0.05
A2	0.20	
A3	-	0.05
b	0.18	0.30
D	2.90	3.10
D1	2.616	
E	4.90	5.10
E1	4.336	
e	1.075	
e1	0.55	
K1	0.125	0.225
L1	0.625	0.825
L2	1.725	1.925
aaa	0.05	
bbb	0.10	
ccc	0.08	
ddd	0.05	
eee	0.10	

NOTE:  
DIMENSIONS DO NOT INCLUDE MOLD FLASH,  
PROTRUSION OR GATE BURRS

Figure 1 Outline PG-TSON-6, dimensions in mm

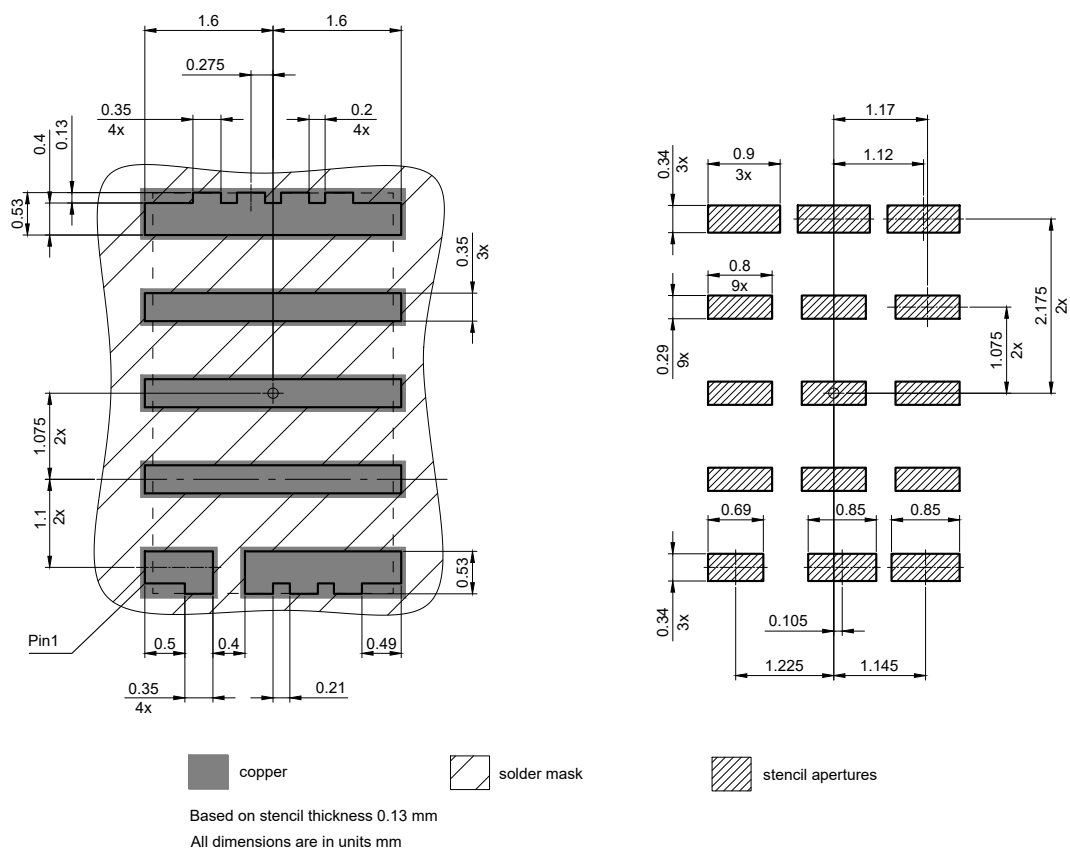

**Figure 2 Footprint drawing PG-TSON-6, dimensions in mm**

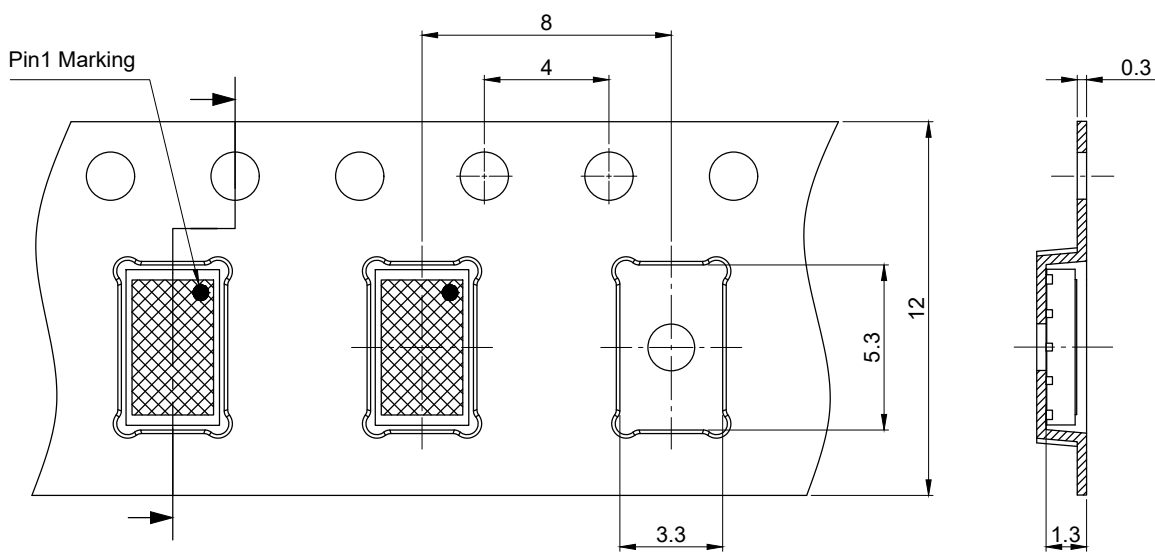

All dimensions are in units mm  
The drawing is in compliance with ISO 128-30, Projection Method 1 [  ]

**Figure 3** Packaging variant PG-TSON-6, dimensions in mm

## 7 Appendix A

Table 9 Related links

- [IFX CoolGaN™ GaN webpage](#)
- [IFX CoolGaN™ reliability white paper](#)
- [IFX CoolGaN™ gate driver application note](#)
- [IFX CoolGaN™ Evaluation Boards](#)
- [IFX Packages Description-PG-TSON-6-2](#)



## Revision history

IGC033S10S1

### Revision 2024-12-10, Rev. 1.0

Previous revisions

Revision	Date	Subjects (major changes since last revision)
1.0	2024-12-10	Release of final

#### Trademarks

All referenced product or service names and trademarks are the property of their respective owners.

**We Listen to Your Comments** Any information within this document that you feel is wrong, unclear or missing at all? Your feedback will help us to continuously improve the quality of this document. Please send your proposal (including a reference to this document) to: [erratum@infineon.com](mailto:erratum@infineon.com)

#### Published by

Infineon Technologies AG  
81726 München, Germany  
© 2024 Infineon Technologies AG  
All Rights Reserved.

#### Legal Disclaimer

The information given in this document shall in no event be regarded as a guarantee of conditions or characteristics ("Beschaffenheitsgarantie"). With respect to any examples, hints or any typical values stated herein and/or any information regarding the application of the product, Infineon Technologies hereby disclaims any and all warranties and liabilities of any kind, including without limitation warranties of non-infringement of intellectual property rights of any third party.

In addition, any information given in this document is subject to customer's compliance with its obligations stated in this document and any applicable legal requirements, norms and standards concerning customer's products and any use of the product of Infineon Technologies in customer's applications.

The data contained in this document is exclusively intended for technically trained staff. It is the responsibility of customer's technical departments to evaluate the suitability of the product for the intended application and the completeness of the product information given in this document with respect to such application.

#### Information

For further information on technology, delivery terms and conditions and prices please contact your nearest Infineon Technologies Office ([www.infineon.com](http://www.infineon.com)).

#### Warnings

Due to technical requirements, components may contain dangerous substances. For information on the types in question, please contact the nearest Infineon Technologies Office.

The Infineon Technologies component described in this Data Sheet may be used in life-support devices or systems and/or automotive, aviation and aerospace applications or systems only with the express written approval of Infineon Technologies, if a failure of such components can reasonably be expected to cause the failure of that life-support, automotive, aviation and aerospace device or system or to affect the safety or effectiveness of that device or system. Life support devices or systems are intended to be implanted in the human body or to support and/or maintain and sustain and/or protect human life. If they fail, it is reasonable to assume that the health of the user or other persons may be endangered.