

# DT06-6S-CE13 ✓ ACTIVE

DEUTSCH | DEUTSCH DT

TE Internal #: DT06-6S-CE13

6 Position Housing, Housing for Female Terminals, Wire-to-Wire, 4.44 mm [.175 in] Centerline, Sealable, Black, Wire & Cable, Power, DEUTSCH DT

[View on TE.com >](#)



Connectors > Automotive Connectors > Automotive Housings > DEUTSCH DT Plug Connectors



Number of Positions: 6

Connector & Housing Type: **Housing for Female Terminals**

Mating Pin Diameter: 1.59 mm [.063 in]

Connector System: **Wire-to-Wire**

Centerline (Pitch): 4.44 mm [.175 in]

[All DEUTSCH DT Plug Connectors \(204\)](#)

## Features

### Industry Standards

IP Rating	IP6K9K, IP68
Compatible With Agency/Standards Products	SAE J2030
UL Flammability Rating	12mm Flame Test per Standard UL-94

### Dimensions

Row-to-Row Spacing	4.45 mm [.175 in]
Compatible Insulation Diameter Range	1.35 – 3.05 mm [.053 – .12 in]
Product Width	20.68 mm [.814 in]
Product Length	43.21 mm [1.701 in]
Connector Height	24.03 mm [.946 in]

### Packaging Features

Packaging Quantity	550
Packaging Method	Box



### Mechanical Attachment

Strain Relief	Add By Accessory
Terminal Position Assurance	Yes
Mating Alignment Type	Polarized
Mating Alignment	With
Connector Mounting Type	Cable Mount (Free-Hanging)

### Other

Serviceable	Yes
Connector Position Assurance Capable	No
EU RoHS Compliance	Compliant
EU ELV Compliance	Compliant

### Electrical Characteristics

Operating Voltage	250 VDC
Nominal Voltage Architecture	250 V

### Body Features

Cable Exit Angle	180°
Primary Product Color	Black

### Housing Features

Housing Material	PA GF
Centerline (Pitch)	4.44 mm [.175 in]

### Contact Features

Contact Size	Size 16
Contact Type	Socket
Mating Pin Diameter	1.59 mm [.063 in]
Contact Current Rating (Max)	13 A

### Product Type Features

Mixed & Hybrid Connector	No
Connector Shape	Rectangular
Connector & Housing Type	Housing for Female Terminals
Connector System	Wire-to-Wire
Sealable	Yes
Primary Locking Feature	Integrated in Housing



Connector & Contact Terminates To	Wire & Cable
-----------------------------------	--------------

### Configuration Features

Blank Cavity Position	0
Connector Modification	Enhanced Seal Retention, Shrink Boot Adapter
Connector Seal Code	E Seal
Number of Positions	6
Number of Rows	2

### Usage Conditions

Operating Temperature (Max)	125 °C[257 °F]
Operating Temperature Range	-55 – 125 °C[-67 – 257 °F]

### Operation/Application

Circuit Application	Power
---------------------	-------

### Product Compliance

[For compliance documentation, visit the product page on TE.com>](#)

EU RoHS Directive 2011/65/EU	Compliant
EU ELV Directive 2000/53/EC	Compliant
China RoHS 2 Directive MIIT Order No 32, 2016	No Restricted Materials Above Threshold
EU REACH Regulation (EC) No. 1907/2006	Current ECHA Candidate List: JUNE 2024 (241) Candidate List Declared Against: JUNE 2024 (241) SVHC > Threshold: Octamethylcyclotetrasiloxane (D4) (.5% in Component Part) Dodecamethylcyclohexasiloxane (D6) (.5% in Component Part) Decamethylcyclopentasiloxane (D5) (.5% in Component Part) <b>Article Safe Usage Statements:</b> Wash thoroughly after handling. Recycle if possible and dispose of the article by following all applicable governmental regulations relevant to your geographic location.
Halogen Content	Not Low Halogen - contains Br or Cl > 900 ppm.
Solder Process Capability	Not reviewed for solder process capability

#### Product Compliance Disclaimer

This information is provided based on reasonable inquiry of our suppliers and represents our current actual knowledge based on the information they provided. This information is subject to change. The part numbers that TE has identified as



EU RoHS compliant have a maximum concentration of 0.1% by weight in homogenous materials for lead, hexavalent chromium, mercury, PBB, PBDE, DBP, BBP, DEHP, DIBP, and 0.01% for cadmium, or qualify for an exemption to these limits as defined in the Annexes of Directive 2011/65/EU (RoHS2). Finished electrical and electronic equipment products will be CE marked as required by Directive 2011/65/EU. Components may not be CE marked. Additionally, the part numbers that TE has identified as EU ELV compliant have a maximum concentration of 0.1% by weight in homogenous materials for lead, hexavalent chromium, and mercury, and 0.01% for cadmium, or qualify for an exemption to these limits as defined in the Annexes of Directive 2000/53/EC (ELV). Regarding the REACH Regulation, the information TE provides on SVHC in articles for this part number is based on the latest European Chemicals Agency (ECHA) 'Guidance on requirements for substances in articles' posted at this URL: <https://echa.europa.eu/guidance-documents/guidance-on-reach>

## Compatible Parts



TE Part # 1010-070-0606  
SEAL, INTF, 6P, RED-ORG, SL RET, DT



TE Part # CAT-D48-SP729  
DEUTSCH Sealing Plugs



TE Part # DT-RT1  
EXT TOOL, FRONT RELEASE



TE Part # 1011-347-0605  
DUST CAP, 6P, PLG, BLK, DT



TE Part # 1062-14-0177  
SOC, SF, SIZE 16, 14-18, SN/SN



TE Part # CAT-D487-CH8172  
DEUTSCH DT Series Housings & Connectors



TE Part # CAT-J67-DSCC16  
DEUTSCH Size 16 Crimp Contacts



TE Part # CAT-D48-ST273  
DEUTSCH Solid Contacts



TE Part # CAT-J41-DDRC  
DEUTSCH DT Receptacle Connectors



TE Part # W6S-P012  
WEDGE LOCK, 6P, PLG, GRN, SL RET, DT



TE Part # CAT-D487-H342  
DEUTSCH DT Headers



TE Part # DT06-6S-C015  
PLG, 6P, GRY, E

## Also in the Series | DEUTSCH DT

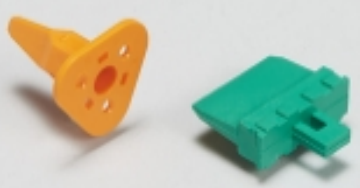

Automotive Connector Locks & Position Assurance(90)



Automotive Headers(107)



Automotive Housings(738)



Connector Caps & Covers(1)



Connector Strain Relief(31)



Insertion & Extraction Tools(3)

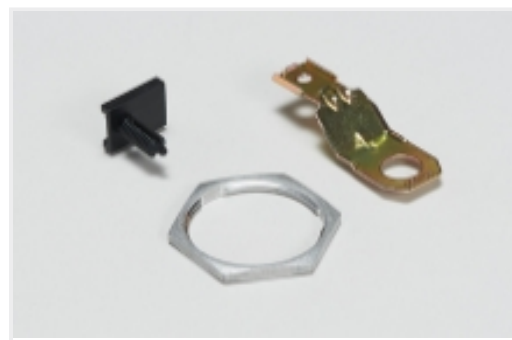

Other Automotive Connector Accessories(28)



Rectangular Backshells & Clamps(3)

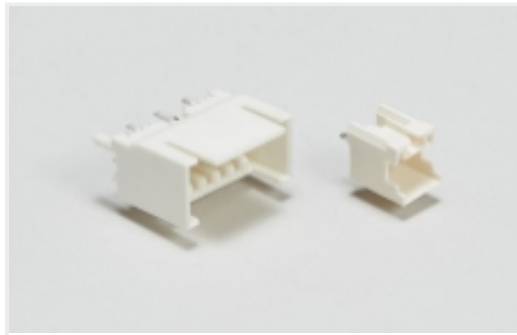

Wire-to-Board Headers & Receptacles (106)

## Customers Also Bought



TE Part #W6S-P012  
WEDGE LOCK, 6P, PLG, GRN, SL RET, DT



TE Part #CAT-J41-DDPC  
DEUTSCH DT Plug Connectors



TE Part #DT04-4P-CE09  
REC, 4P, BLK, E, XCAP



TE Part #2837060-1  
OCEAN\_2.0\_Applicator-S-076F076O-RSM



TE Part #2217206-1  
Blade, Slug



TE Part #CAT-C7679-T548  
CONTINUOUS TUBE MILITARY GRADE TMS-CT

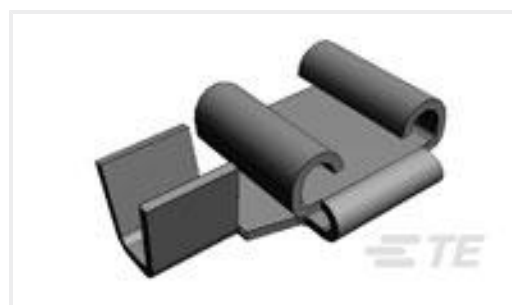

TE Part #63647-3  
250 FASTON FLAG REC 18-14 AWG TPBR

## Documents

### Product Drawings

PLG, 6P, BLK, E, SEAL RET, XCAP

English

### CAD Files

3D PDF

3D

Customer View Model

ENG\_CVM\_CVM\_DT06-6S-CE13\_B.2d\_dxf.zip



English

**Customer View Model**

[ENG\\_CVM\\_CVM\\_DT06-6S-CE13\\_B.3d\\_igs.zip](#)

English

**Customer View Model**

[ENG\\_CVM\\_CVM\\_DT06-6S-CE13\\_B.3d\\_stp.zip](#)

English

By downloading the CAD file I accept and agree to the [Terms and Conditions](#) of use.

---

## Datasheets & Catalog Pages

[TERMINALS AND CONNECTORS](#)

English

[DEUTSCH DT Enhanced Seal Retention Connectors](#)

English

[ICT Terminals and Connectors Catalogue](#)

English

[CONNECTOR SELECTOR](#)

English

---

## Product Specifications

[Application Specification](#)

English

---

## Agency Approvals

[UL Report](#)

English