

multicomp^{PRO}



Multiple Channel Digital Control and Programmable DC Power Supply

72-2630 72-2635 72-2640 and 72-2645



INFORMATION ON WASTE DISPOSAL FOR CONSUMERS OF ELECTRICAL & ELECTRONIC EQUIPMENT.

When this product has reached the end of its life it must be treated as Waste Electrical & Electronic Equipment (WEEE). Any WEEE marked products must not be mixed with general household waste, but kept separate for the treatment, recovery and recycling of the materials used. Contact your local authority for details of recycling schemes in your area.



Made in China
150 Armley Road, Leeds, LS12 2QQ (UK)
Riverside One, Sir John Rogerson Quay, Dublin 2, D02 X576 (EU)
Man Rev 1.0

□ **Table of Contents**

SAFETY INSTRUCTIONS1

 Safety Symbols..... 1

 Introduction.....3

OVERVIEW.....4

 Front Panel Overview4

 Rear Panel Overview4

FUNCTION INTRODUCTION5

 Operation of Voltage5

 Operation of current5

 The Series and Parallel Operation.....6

 Recall to output.....7

 The Operation of Overcurrent Protection.....7

 The Operation of Overvoltage Protection.....8

 Keyboard Lock.....8

 Beep ON/OFF.....8

REMOTE CONTROL9

REMOTE CONTROL SYNTAX V2.0' 10

SPECIFICATIONS..... 13

SAFETY INSTRUCTIONS

This chapter contains important safety instructions that you must follow when operating the 72-2630 & 72-2635 & 72-2640 & 72-2645 and during storage. Read the following before any operation to insure your safety.

Safety Symbols

These safety symbols may appear in this manual or on the series.



WARNING



DANGER High Voltage



Earth (ground) Terminal

Reaction Time		
Voltage Rise	≤100ms	≤100ms
Voltage Drop	≤100ms (10% Rated load)	≤100ms (10% Rated load)
Load Regulation of Parallel		
Voltage	≤0.1%+0.1V	
Load Regulation of Series		
Voltage	≤0.1%+0.1V	
CH3 Specifications (only for 72-2645)		
Voltage Range	5V	
Current Range	3A	
Voltage Accuracy	±50mV	
Load Regulation	±50mV	
Accessories supplied		
User manual 1 PC, power cord 2 PC, USB cable 1 PC (only for 72-2635 & 72-2645)		
Weight and Dimensions(mm)		
250(W)*143(H)*375(D), 72-2630/72-2635x7.8kg, 72-2640/72-2645x10.3kg		

Specifications

Note: The specifications below are tested under the conditions of temperature 25°C±5°C and the warm-up for 20 minutes.

Models	72-2630/72-2635	72-2640/72-2645
Voltage Range	0-30Vx2, 5Vx1	0-30Vx2, 5Vx1
Current Range	0-3Ax2, 3Ax1	0-5Ax2, 5Ax1
Load Regulation		
Voltage	≤0.01%+3mv	≤0.01%+5mv
Current	≤0.1%+5mA	≤0.1%+10mA
Line Regulation		
Voltage	≤0.01%+3mv	≤0.01%+3mv
Current	≤0.1%+3mA	≤0.1%+3mA
Setup Resolution		
Voltage	10mV	10mV
Current	1mA	1mA
Setup Accuracy (25°C±5°C)		
Voltage	≤0.5%+20mV	≤0.5%+20mV
Current	≤0.5%+5mA	≤0.5%+10mA
Ripple (20-20M)		
Voltage	≤1mVrms	≤2mVrms
Current	≤3mArms	≤3mArms
Temp. Coefficient		
Voltage	≤150ppm	≤150ppm
Current	≤150ppm	≤150ppm
Read Back Accuracy		
Voltage	10mV	10mV
Current	1mA	1mA
Read Back Temp. Coefficient		
Voltage	≤150ppm	≤150ppm
Current	≤150ppm	≤150ppm

Safety Guidelines

- Do not block or obstruct the cooling fan vent opening.
- Avoid severe impacts or rough handling leading to damage.
- Do not discharge static electricity.
- Do not disassemble unless you are qualified as service personnel.

AC Input



- AC Input Voltage: 230V , 50/ 60 Hz
- Connect the protective grounding conductor of the AC power cord to an earth ground, to avoid electrical shock.

Operation Environment

- Location: Indoor, no direct sunlight, dust free, almost non-conductive pollution, Relative Humidity:< 80%
Altitude:< 2000m
- Temperature: 0-40°C
- Location: Indoor

Storage Environment

- Relative Humidity:< 70
- Temperature:-10-70°C

FUSE



Model	220V/230V AC
72-2630	T3A/250V(20x5mm)
72-2635	T3A/250V(20x5mm)
72-2640	T5A/250V(20x5mm)
72-2645	T5A/250V(20x5mm)

- To ensure fire protection, replace the fuse only with the specified type and rating.
- Disconnect the power cord before fuse replacement.
- Make sure the cause of the fuse blowing is fixed before fuse replacement.

Introduction

72-2630 & 72-2635 & 72-2640 & 72-2645 series are multiple-channel digital control and programmable power supplies, which reflect a variety of features about digital control, such as the fast recall, and the parameters setting of Overcurrent Protection and Overvoltage Protection independently to provide the convenient and reliable operation environment.

They use efficient radiators and low-speed & stepless-speed fan, for efficient cooling during operation.

Main Features

- 4 digit displays, and accurate outputs
- Parameters settings on Overcurrent
- Protection and Overvoltage Protection
- 5 groups of memories for fast recall
- Shutdown memory function
- Software calibration
- Keyboard Lock
- Low-speed and stepless-speed fan
- Overtemperature Protection

13. SAV<NR1>

Description: Stores the panel setting

NR1 1 5: Memory number 1 to 5

Example: SAV1 Stores the panel setting in memory number 1

14. TRACK<NR1>

Description: Sets the output of the power supply working on independent or tracking mode. NR1: 0=INDEP, 1=SER, 2=PARA

Example: TRACK1

15. OCP<Boolean>

Description: Stores the panel setting

Boolean: 0 OFF, 1 ON

Example: OCP1 Turns on the OCP

16. OVP<Boolean>

Description: Turns on the OVP

Boolean: 0 OFF, 1 ON

Example: OVP1 Turns on the OVP

17. OCPSTE: <X>:<NR2>

Description: Setting the value of current protection Example:
OCPSTE1: 5.100

18. OVPSTE: <X>:<NR2>

Description: Setting the value of voltage protection Example:
OVPSTE1: 31.00

7. VOUT<X>?

Description: Returns the actual output voltage. Example VOUT1?
Returns the CH1 output voltage

8. OUT<Boolean>

Description: Turns on or off the output.
Boolean: 0=OFF, 1=ON
Example: OUT1 Turns on the output

9. BEEP<Boolean>

Description: Turns on or off the beep.
Boolean: boolean logic.
Example: BEEPI Turns on the beep.

10. STATUS?

Description: Returns the POWER SUPPLY status. Contents 8 bits in the following format:-

Bit	Item	Description
0	CH 1	0=CC mode, 1=CV mode
1	CH2	0=CC mode, 1=CV mode
2,3,4,5	N/A	
6	Output	0=Off, 1=On N/
7	AN/A	

11. *IDN?

Description: Returns the 72-2645 identification.
Example: *IDN?
Contents MULTICOMP 72-2645 V2.0
(Manufacturer, model name,).

12. RCL<NRI>

Description: Recalls a panel setting.

Front Panel Overview

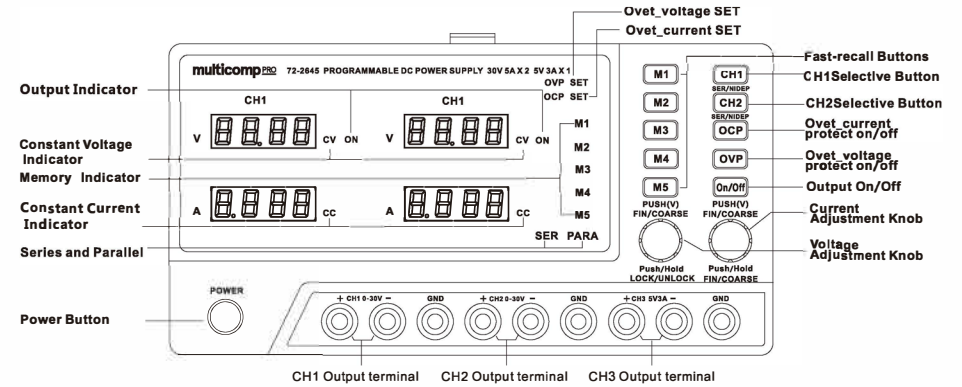

Rear Panel Overview

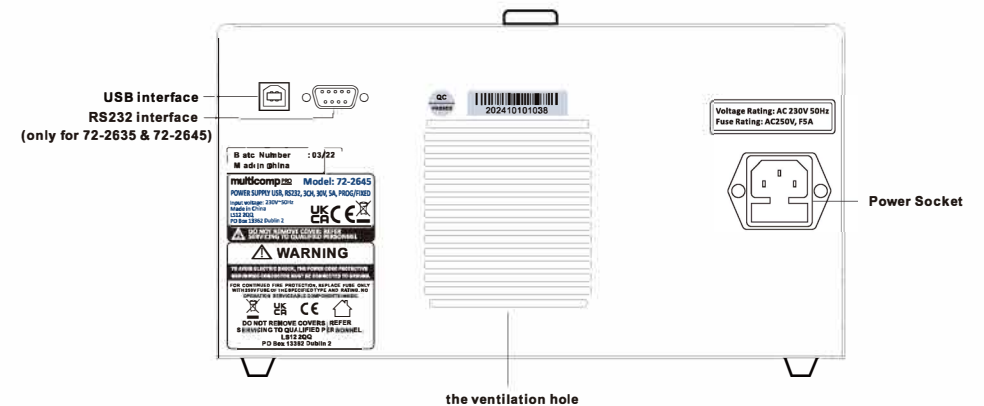

Function Introduction

1. The Operation and Outputs of Voltage and Current

Press the CH1 button until the CH1 display indicator flashes; press CH1 again and the voltage digit on the channel 1 flashes. The voltage value can then be set by adjusting the voltage adjustment knob.

Press CH1 button again while the voltage digit is flashing to switch into the current setting, then the current value can be set by adjusting the current adjustment knob.

Pressing the voltage or current adjustment knob and the flashing digit (i.e. the digit to be adjusted) can be changed.

After the voltage and current values are set, press the button ON/OFF to turn on the output, when the ON indicator on the display will be switched on; press the button ON/OFF again to turn off the output and at this time the ON indicator will be switched off.

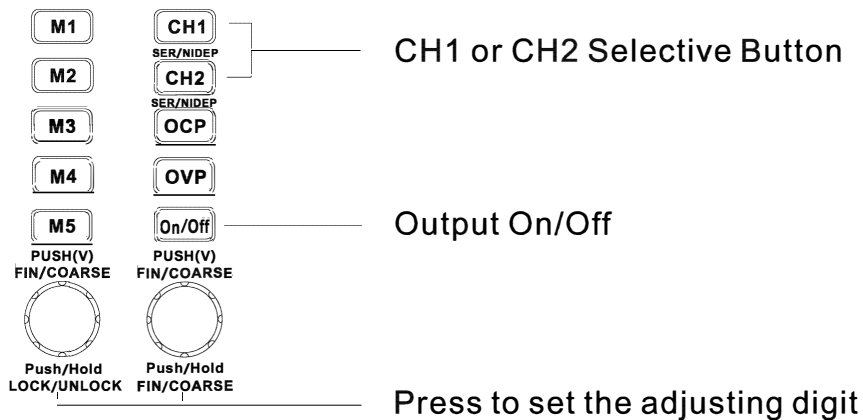

Remote Control Syntax V2.0

Command format : VSET <X>:<NR2>

1. VSET:command header
2. X:output channel
3. :separator
4. NR2:parameter

Command Details:

1. LOCK<NR2>

Description: LOCK or UNLOCK the front panel Example:LOCK1
 LOCK the front panel
 Example:LOCK0
 UNLOCK the front panel

2. ISET<X>:<NR2>

Description: Sets the output current.
Example:ISET1:2.225
 Response time 50ms
 Sets the CH1 output current to 2.225A

3. ISET<X>?

Description: Returns the output current setting.
 Example: **ISET1?**
 Returns the CH1 output current setting.

4. VSET<X>:<NR2>

Description: Sets the output voltage.
ExampleVSET1:20.50
 Sets the CH1 voltage to 20.50V

5. VSET<X>?

Description: Returns the output voltage setting.
 Example: **VSET1?**
 Returns the CH1 voltage setting

6. IOUT<X>?

Description: Returns the actual output current.
 Example: **IOUT1?**
 Returns the CH1 output current

REMOTE CONTROL

COM setting Set up the PC COM port according to the following specification:

- Baud rate: 9600
- Parity bit: None
- Data bit: 8
- Stop bit: 1
- Data flow control: None

Pin outs for RS232 interface

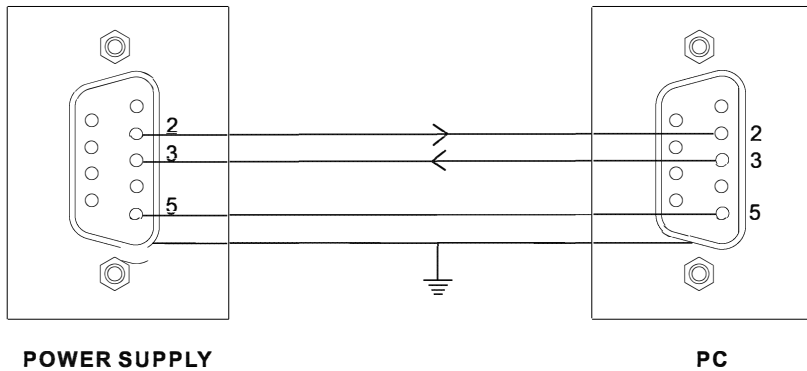

Functionality check Run this query command via the terminal application such as MTTY (Multi-threaded TTY).
 *DIN?
 This should return the identification information: Manufacturer, model name, software version. MULTICOMP 72-2645 Vx.xx

2. Series and Parallel Operation

Series Operation: Press and hold the button CH1 for 3 seconds to be in the series mode. When the SER indicator on the display lights on, it means the power supply is in the series mode now. At this mode, CH2 is the master operation while CH1 is the slave operation, when the CH1 operation is shielded. At this time, press the button ON/OFF and then the output can be turned on or off. And the output connection is as shown in the figure:

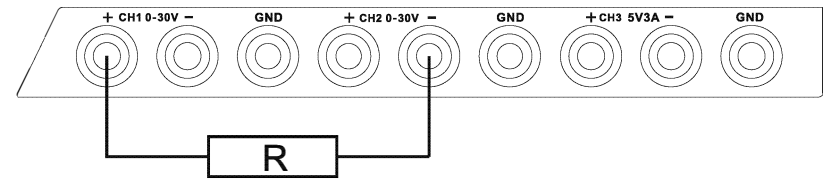

Parallel Operation: Press and hold the button CH1 for 3 seconds to be in the parallel mode. When the PARA indicator on the display lights on, it means the power supply is in the parallel mode now. At this mode, CH2 is the master operation while CH1 is the slave operation, when the CH1 operation is shielded. At this time, press the button ON/OFF and then the output can be turned on or off. And the output connection is as shown in the figure:

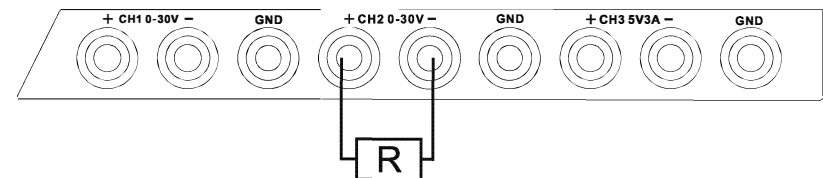

3. Recall to output

In any state, just press the buttons M1-M5 and then the according memories can be recalled.

4. Overcurrent Protection

Press and hold the button "OCP" for 3 seconds to enter the mode of OCP setting, when the indicator "OCP SET" lights on. And the current values on both CH1 and CH2 display the OCP values accordingly. By adjusting the current knob, the OCP value can be changed. Press and hold the button "OCP" again for 3 seconds to exit. Furthermore, press the button "OCP" to switch on the Overcurrent Protection (OCP) mode and the indicator "OCP" is turned on; press the button "OCP" again to shut down the OCP mode and the indicator "OCP" will be turned off. When the OCP mode is on, if the current value on the load or the setting current is more than that in the OCP SET, the output will be cut off.

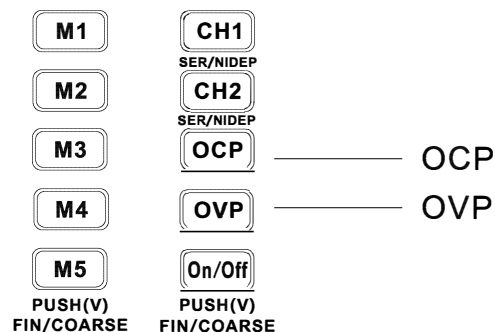

5. Overvoltage Protection (OVP) Setting

Press and hold the button "OVP" for 3 seconds to enter the mode of OVP setting, when the indicator "OVP SET" lights on. And the voltage values on both CH1 and CH2 display the OVP values accordingly. By adjusting the voltage knob, the OVP value can be changed. Press and hold the button "OVP" again for 3 seconds to exit. Furthermore, press the button "OVP" to switch on the Overvoltage Protection (OVP) mode and the indicator "OVP" is turned on; press the button "OVP" again to shut down the OVP mode and the indicator "OVP" will be turned off. When the OVP mode is on, if the voltage value on the load or the setting voltage is more than that in the OVP SET, the output will be cut off.

6. Keyboard Lock

Press and hold the voltage adjustment knob for 3 seconds, and then the front panel will be locked; press and hold it again for 3 seconds, and then it will be unlocked.

7. Beep ON/OFF

Press and hold the current adjustment knob for 3 seconds, and then the beep will be turned off. press and hold it again for 3 seconds, it will be turned on.