

MDT0500BC-USBC	480 x 854	USB-C Interface	TFT Module
Specification			
Version: 1		Date: 28/04/2023	
Revision			
1	26/04/2023	First issue	

Display Features					
Display Size	5.00"			Created By	Checked By
Resolution	480 x 854				
Orientation	Portrait				
Appearance	RGB				
Supply Voltage	5V				
Interface	USB-C				
Brightness	542 cd/m ²				
Touchscreen	CTP				
Module Size	67.56 x 122.35 x 15.25 ^{MAX} mm				
Operating Temperature	-20°C ~ +70°C	Box Quantity	Weight / Display		
Pinout	N/A	---	---		
Pitch	N/A				

DESIGN • MANUFACTURE • SUPPLY

* - For full design functionality, please use this specification in conjunction with the ILI9806E display driver specification.(Provided Separately)

Display Accessories	
Part Number	Description

Optional Variants	
Appearances	Voltage



1. Basic Specifications

* Description

This is a plug and play device, this is a color active matrix TFT (Thin Film Transistor) LCD (liquid crystal display) that uses amorphous silicon TFT as a switching device. This module is composed of a transmissive type TFT-LCD Panel, driver circuit, capacitance touch panel, back-light unit, TYPE C AD board. The resolution of a 5.0 " TFT-LCD contains 480x854 pixels, and can display up to 16.7M colors.

* Operating Instructions

This product supports the following operating systems: Windows 8/10/11, Android, Linux, etc.

1. Connect the type c connector.

2. Connect the type c cable to Windows 8/10/11 or Android or Linux, etc.

1.1 TFT Features

General Information Items	Specification	Unit	Note
	Main Panel		
Display area(AA)	61.632(H)*109.6536(V) (5.0inch)	mm	
Driver element	TFT active matrix	-	
Display colors	16.7M	colors	
Number of pixels	480(RGB)*854	dots	
Pixel arrangement	RGB vertical stripe	-	
Pixel pitch	0.1284(H)*0.1284(V)	mm	
Viewing angle	ALL	o'clock	
Display mode	Transmissive /Normally Black	-	
Module bonding technology	Use tape bonding between LCM and CTP	-	
Operating temperature	-20~+70	°C	
Storage temperature	-30~+80	°C	

1.2 Module Features

General Information Items	Specification	Unit	Note
Display Interface	Type C	-	
Touch Interface	Type C	-	
Touch Type	Capacitive touch panel	-	
Touch Mode	Multiple point	-	
Power supply	Type C	-	



Note: Video and touch and power are transferred by type c cable.

1.3 Mechanical Information

Item		Min.	Typ.	Max.	Unit	Note
Module size	Horizontal(H)	-	67.56		mm	
	Vertical(V)	-	122.35		mm	
	Depth(D)	-	--	15.25	mm	
Weight		-	TBD	-	g	

2. Block Diagram

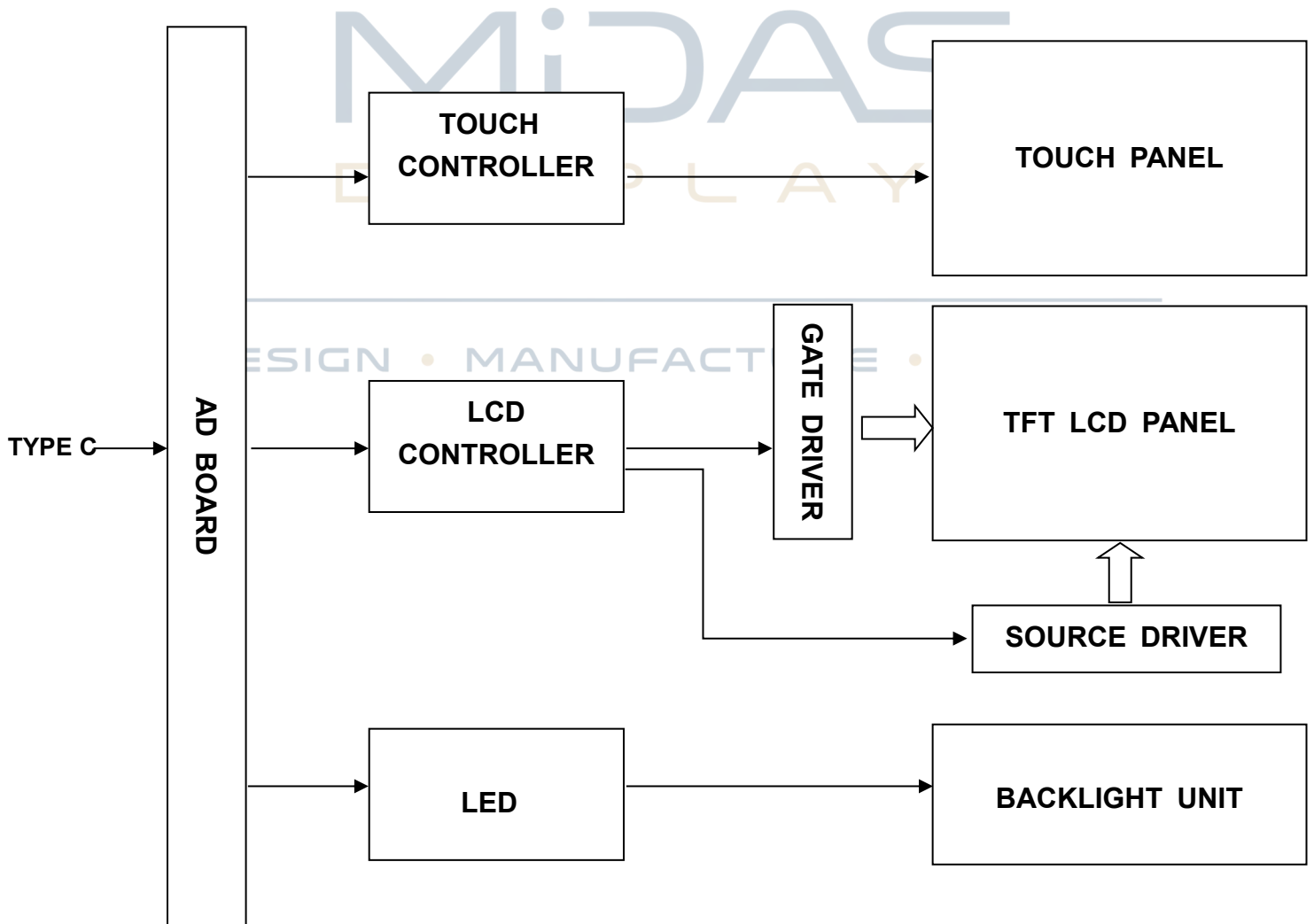

3. Outline dimension

Rev.	Revision content description	Date
V0	FIRST	2023.02.17

COMMENTS: OUT
REV: 03/04/05-06/01

USB2: Type C
USB1: VBUS_5V/2A
USB2: Type C

COMPONENTS LIST:

Pin	Value
1	GND
2	MPI_RST
3	MPI_RST
4	LOG_2.3V
5	LOG_2.3V
6	CP_30A
7	CP_30A
8	CP_INT
9	CP_RST
10	BL_VDD
11	BL_VDD
12	GND
13	GND
14	MPI_DSN
15	MPI_DSN
16	MPI_DSN
17	MPI_DSN
18	MPI_DSN
19	GND
20	MPI_CLK
21	MPI_CLK
22	GND
23	MPI_DIN
24	MPI_DIN
25	GND
26	MPI_DON
27	MPI_DON
28	GND
29	GND
30	LOG_2.3V
31	LOG_2.3V
32	CP_SCL
33	CP_SDA
34	CP_INT
35	CP_RST
36	USB_DP
37	USB_DP
38	VBUS_5V
39	GND
40	GND

Notes:

- DISPLAY TYPE: 5.0", TFT-LCD, 65K/262K/16.7M COLORS
- DISPLAY MOUNT: PPS NORMALLY BLACK
- VIEWING DIRECTION: ALL
- TFT DRIVER IC: IL9306G(COG)
- CP DRIVER IC: G9311
- Touch type: CTP
- Module Interface: USB Type-C
- POWER IN: USB (5V/2A) or Micro-USB (5V/2A)
- touch and LCD Bonding technology: TSP
- OPERATING TEMP: -20° C TO 70° C
- STORAGE TEMP: -50° C TO 80° C
- Contrast Ratio: NC
- Module Brightness: TBD ed m2(TYP)
- RoHS COMPLIANT.
- ** critical dimension; () reference dimension.

USB2: Type C (M/1262-241N-4BY64)

Pin	Logic	Pin	Logic
1	GND	9	VBUS_5V
2	DP-DP+	10	DP-D2P
3	DP-DN	11	DP-D2N
4	VBUS_5V	12	GND
5	CC1	13	GND
6	USB_DP	14	DP-D3P
7	USB_DN	15	DP-D3N
8	AUXN	16	VBUS_5V

CONV4:

Pin	Logic	Pin	Logic
1	OFF/ON	2	NC
2	BLK-	3	BLK+
3	BLK+	4	GND

CONV1:

Pin	Logic	Pin	Logic
1	VBUS_5V	17	CC2
2	NC	18	USB_DP
3	NC	19	USB_DN
4	NC	20	AUXP
5	GND	21	VBUS_5V
6	GND	22	DP_D0P
7	GND	23	DP_D0N
8	GND	24	GND

USB1: Micro-USB/USB-NC-401-05

Pin	Logic	Pin	Logic
1	VBUS_5V	2	NC
2	NC	3	NC
3	NC	4	NC
4	NC	5	GND

MIDAS DISPLAYS

DRAWING NAME: MDT0500BC-USBC

PARTS NO.:

Unit: mm

TOLERANCE: X.XX±0.2

Scale: 1:1

Page: 1/1

4. Pin Assignment

4.1 Type C Input

NO.	SYMBOL	DESCRIPTION	I/O
A1	GND	Ground.	P
A2	SSTXP1	Positive TX Super Speed Differential Signal #1.	I
A3	SSTXN1	Negative TX Super Speed Differential Signal #1.	I
A4	VBUS	Supply voltage(5V).	P
A5	CC1	Configuration channel.	I
A6	DP1	USB2.0+ signal.	I
A7	DN1	USB2.0- signal.	I
A8	SBU1	Sideband use (SBU)	I
A9	VBUS	Supply voltage(5V).	P
A10	SSRXN2	Negative RX Super Speed Differential Signal #2.	I
A11	SSRXP2	Positive RX Super Speed Differential Signal #2.	I
A12	GND	Ground.	P
B1	GND	Ground.	P
B2	SSTXP2	Positive TX Super Speed Differential Signal #2.	I
B3	SSTXN2	Negative TX Super Speed Differential Signal #2.	I
B4	VBUS	Supply voltage(5V).	P
B5	CC2	Configuration channel.	I
B6	DP2	USB2.0+ signal.	I
B7	DN2	USB2.0- signal.	I
B8	SBU2	Sideband use (SBU)	I
B9	VBUS	Supply voltage(5V).	I
B10	SSRXN1	Negative RX Super Speed Differential Signal #1.	P
B11	SSRXP1	Positive RX Super Speed Differential Signal #1.	P



B12	GND	Ground.	P
-----	-----	---------	---

4.2 Backup power Input

USB1(Micro USB)

NO.	SYMBOL	DESCRIPTION	I/O
1	VBUS_5V	Supply voltage(5V).	P
2	NC	No connection.	
3	NC	No connection.	
4	NC	No connection.	
5	GND	Ground.	P

Note: When the power of type c is not enough, user could enable this power, usually user don't need to enable it.

4.3 Backlight Key Input

CON4(Molex: 53261-0471)

NO.	SYMBOL	DESCRIPTION	I/O
1	OFF/ON	Trun off or turn on backlight.	I
2	BLK-	Reduce brightness of backlight.	I
3	BLK+	Increase brightness of backlight. Note: The brightness is configured for maximum after power on.	I
4	GND	Ground	P

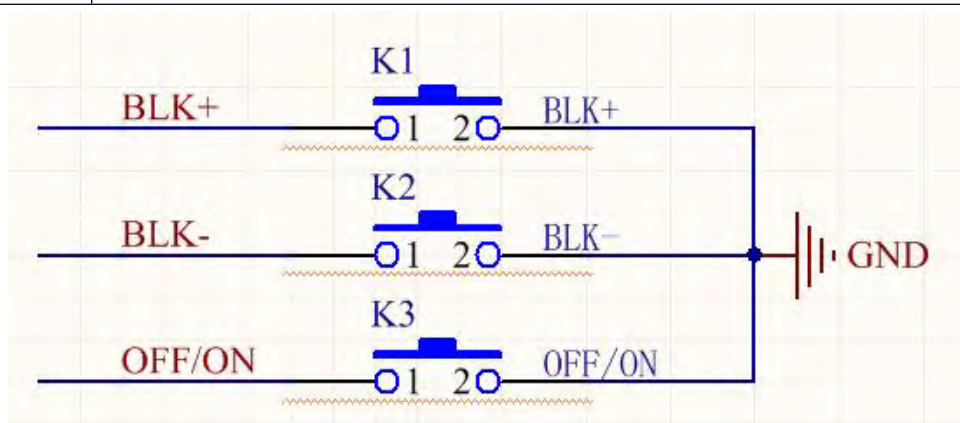

key circuit diagram

5. LCM Optical Characteristics

5.1 Optical specification

Item	Symbol	Condition	Min.	Typ.	Max.	Unit.	Note		
Contrast Ratio	CR	$\Theta=0$ Normal viewing angle	600	800	--		(1)(2)		
Response time	Rising		T_{R+T_F}	--	35	45	msec	(1)(3)	
	Falling			--					
Color Gamut	S(%)		--	61	--	%			
LCM Luminance	LV		500	542		cd/m2			
Color Filter Chromaticity	White		W_X	-0.02	0.286	+0.02		(1)(4) CF glass	
			W_Y		0.312				
	Red		R_X	-0.04	0.632	+0.04			
			R_Y		0.358				
	Green		G_X		0.319				
		G_Y	0.576						
	Blue	B_X	0.145						
		B_Y	0.079						
Viewing angle	Hor.	Θ_L	--		80		--		(1)(4)
		Θ_R	--		80		--		
	Ver.	Θ_U	--	80	--				
		Θ_D	--	80	--				
Option View Direction	Free								

*The data comes from the LCD specification.

Measuring Condition

Measuring surrounding : dark room
 Ambient temperature : 25±2°C
 15min. warm-up time.

Measuring Equipment

FPM520 of Westar Display technologies, INC., which utilized SR-3 for Chromaticity and BM-5A for other optical characteristics.



Note (1): Definition of Viewing Angle :

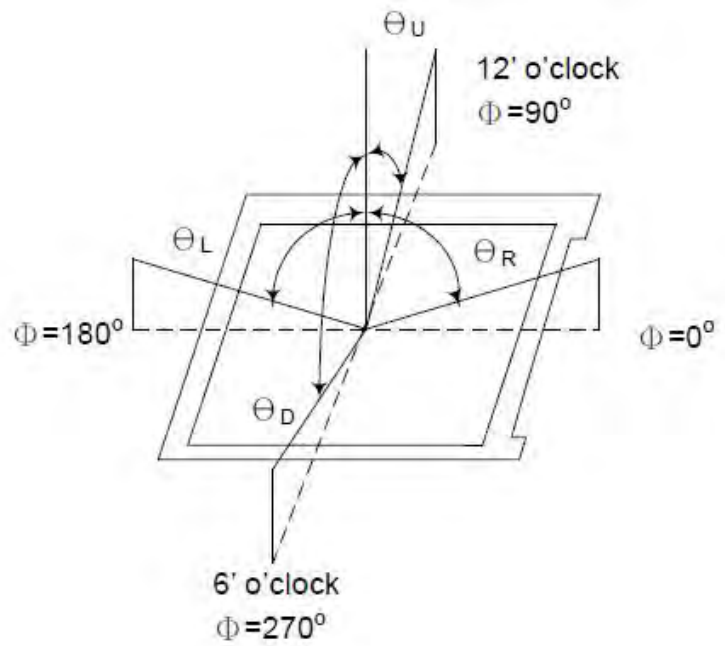

Note (2): Definition of Contrast Ratio(CR) :measured at the center point of panel

$$CR = \frac{\text{Luminance with all pixels white}}{\text{Luminance with all pixels black}}$$

Note (3): Response Time

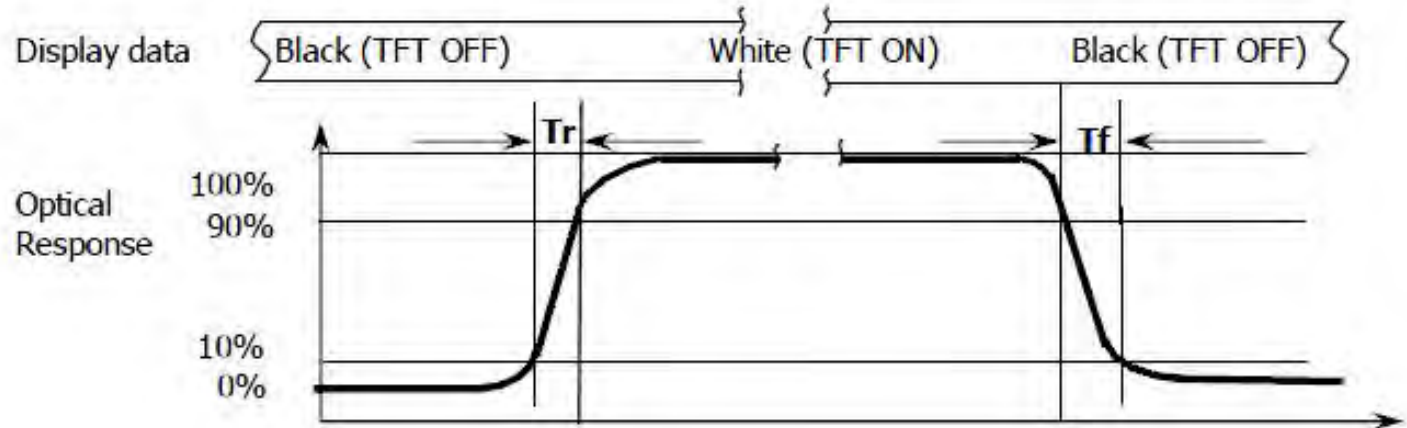

Note (4): Definition of optical measurement setup

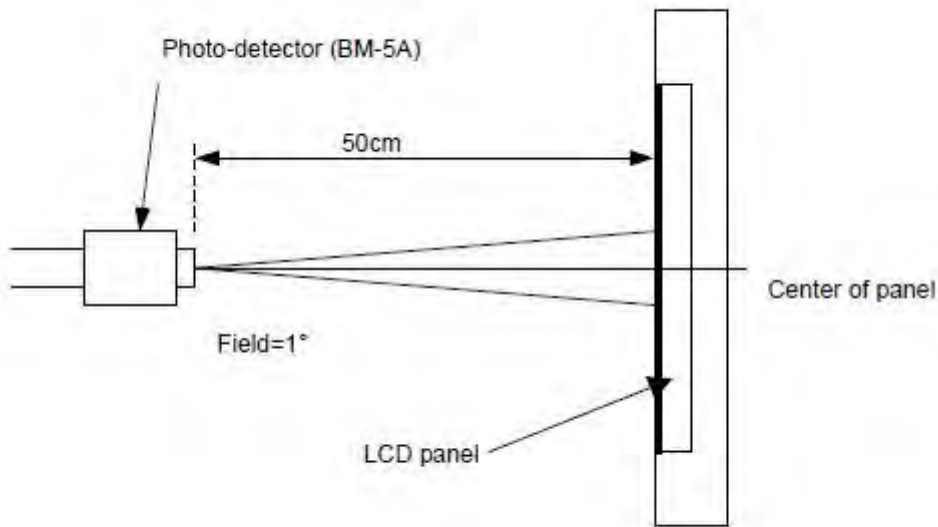

MIDAS
DISPLAYS

DESIGN • MANUFACTURE • SUPPLY



6. Electrical Characteristics

6.1 Absolute Maximum Rating

Characteristics	Symbol	Min.	Max.	Unit	Note
Power Supply Voltage	VBUS	-0.5	6	V	Note1
Operating temperature	T _{OP}	-20	+70	°C	
Storage temperature	T _{ST}	-30	+80	°C	

NOTE1: If the absolute maximum rating of even is one of the above parameters is exceeded even momentarily, the quality of the product may be degraded. Absolute maximum ratings, therefore, specify the values exceeding which the product may be physically damaged. Be sure to use the product within the range of the absolute maximum ratings.



6.2 DC Electrical Characteristics

Characteristics	Symbol	Min.	Typ.	Max.	Unit	Note
Power Supply Voltage	VBUS	4.5	5	5.5	V	
Normal mode Current consumption	I _{VBUS}	--	40	--	mA	



7. LCM Module Out-Going Quality Level

7.1 VISUAL & FUNCTION INSPECTION STANDARD

7.1.1 Inspection conditions

Inspection performed under the following conditions is recommended.

- Temperature : $25 \pm 5^{\circ}\text{C}$
- Humidity : $65\% \pm 10\% \text{RH}$
- Viewing Angle : Normal viewing Angle.
- Illumination: Single fluorescent lamp (300 to 700Lux)
- Viewing distance: 30-50cm

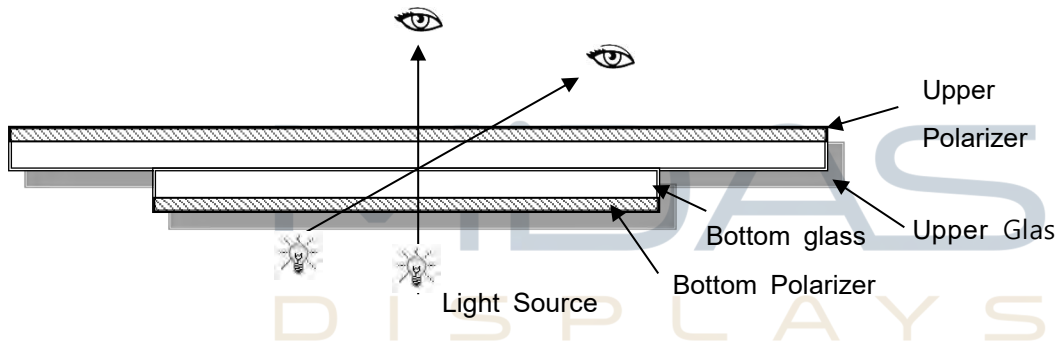

7.1.2 Definition

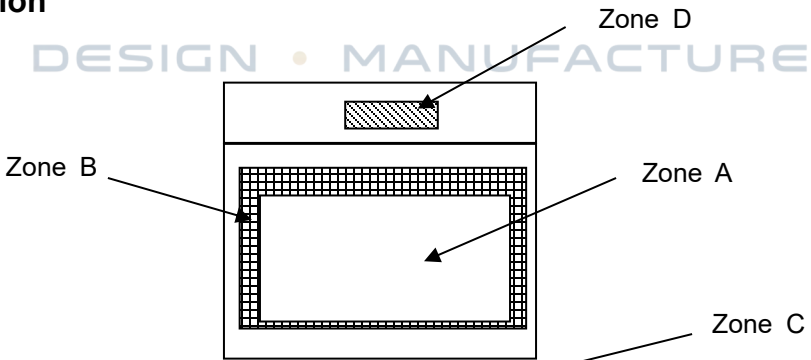

- Zone A : Effective Viewing Area(Character or Digit can be seen)
- Zone B : Viewing Area except Zone A
- Zone C : Outside (Zone A+Zone B) which can not be seen after assembly by customer .)
- Zone D : IC Bonding Area

Note:

As a general rule ,visual defects in Zone C can be ignored when it doesn't effect product function or appearance after assembly by customer



7.1.3 Sampling Plan

According to GB/T 2828-2003 ; , normal inspection, Class II

AQL:

Major defect	Minor defect
0.65	1.5

LCD: Liquid Crystal Display , LCM: Liquid Crystal Module, CTP: Capacitive Touch Panel

No	Items to be inspected	Criteria	Classification of defects
1	Functional defects	1) No display, Open or miss line 2) Display abnormally, Short 3) Backlight no lighting, abnormal lighting. etc	Major
2	Missing	Missing components and etc	
3	Outline dimension	Overall outline dimension beyond the drawing is not allowed, deformation and etc	
4	Color tone	Color unevenness, refer to limited sample	Minor
5	Spot/Line defect	Light dot, Dim spot, (Note1) Polarizer Air Bubble, Polarizer accidented spot and etc	
6	Soldering appearance	Good soldering , Peeling off is not allowed and etc	
7	LCD/Polarizer/CTP	Black/White spot/line, scratch, crack, etc.	

Note1: a) Light dot: Dots appear bright and unchanged in size in which LCD panel is displaying under black pattern.

b) Dim dot: Dots appear dark and unchanged in size in which LCD panel is displaying under pure red, green, blue picture.



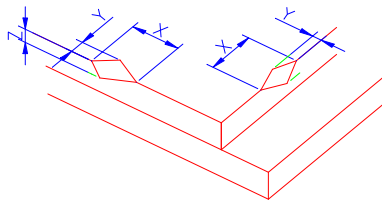
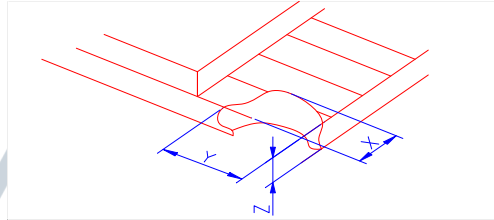
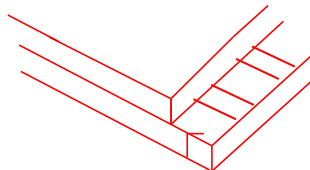

7.1.4 Criteria (Visual)

Number	Items	Criteria(mm)						
1.0 LCD Crack/Broken NOTE: X: Length Y: Width Z: Height L: Length of IT O, T: Height of LCD	(1) The edge of LCD broken	 <table border="1" data-bbox="758 667 1452 817"> <tr> <td>X</td> <td>Y</td> <td>Z</td> </tr> <tr> <td>≤3.0mm</td> <td><Inner border line of the seal</td> <td>≤T</td> </tr> </table>	X	Y	Z	≤3.0mm	<Inner border line of the seal	≤T
X	Y	Z						
≤3.0mm	<Inner border line of the seal	≤T						
	(2) LCD corner broken	 <table border="1" data-bbox="813 1124 1396 1227"> <tr> <td>X</td> <td>Y</td> <td>Z</td> </tr> <tr> <td>≤3.0mm</td> <td>≤L</td> <td>≤T</td> </tr> </table>	X	Y	Z	≤3.0mm	≤L	≤T
X	Y	Z						
≤3.0mm	≤L	≤T						
	(3) LCD crack	 <p style="text-align: center;">Crack Not allowed</p>						

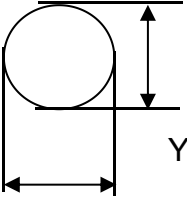

2.0	Spot defect	<p>① light dot (black/white spot , pinhole, stain, etc.)</p> <table border="1"> <thead> <tr> <th rowspan="2">Zone Size (mm)</th> <th colspan="3">Acceptable Qty</th> </tr> <tr> <th>A</th> <th>B</th> <th>C</th> </tr> </thead> <tbody> <tr> <td>$\Phi \leq 0.15$</td> <td colspan="3">Ignore</td> </tr> <tr> <td>$0.15 < \Phi \leq 0.25$</td> <td colspan="3">3(distance ≥ 10mm)</td> </tr> <tr> <td>$0.25 < \Phi \leq 0.4$</td> <td colspan="3">2(distance ≥ 10mm)</td> </tr> <tr> <td>$\Phi > 0.4$</td> <td colspan="3">0</td> </tr> </tbody> </table> <p>② Dim spot (light leakage, dent, dark spot, etc)</p> <table border="1"> <thead> <tr> <th rowspan="2">Zone Size (mm)</th> <th colspan="3">Acceptable Qty</th> </tr> <tr> <th>A</th> <th>B</th> <th>C</th> </tr> </thead> <tbody> <tr> <td>$\Phi \leq 0.15$</td> <td colspan="3">Ignore</td> </tr> <tr> <td>$0.15 < \Phi \leq 0.25$</td> <td colspan="3">3(distance ≥ 10mm)</td> </tr> <tr> <td>$0.25 < \Phi \leq 0.4$</td> <td colspan="3">2(distance ≥ 10mm)</td> </tr> <tr> <td>$\Phi > 0.4$</td> <td colspan="3">0</td> </tr> </tbody> </table> <p>③ Polarizer accidented spot</p> <table border="1"> <thead> <tr> <th rowspan="2">Zone Size (mm)</th> <th colspan="3">Acceptable Qty</th> </tr> <tr> <th>A</th> <th>B</th> <th>C</th> </tr> </thead> <tbody> <tr> <td>$\Phi \leq 0.2$</td> <td colspan="3">Ignore</td> </tr> <tr> <td>$0.2 < \Phi \leq 0.5$</td> <td colspan="3">2(distance ≥ 10mm)</td> </tr> <tr> <td>$\Phi > 0.5$</td> <td colspan="3">0</td> </tr> </tbody> </table> <p>④ Polarizer Bubble</p> <table border="1"> <thead> <tr> <th rowspan="2">Zone Size (mm)</th> <th colspan="3">Acceptable Qty</th> </tr> <tr> <th>A</th> <th>B</th> <th>C</th> </tr> </thead> <tbody> <tr> <td>$\Phi \leq 0.2$</td> <td colspan="3">Ignore</td> </tr> <tr> <td>$0.2 < \Phi \leq 0.4$</td> <td colspan="3">2(distance ≥ 10mm)</td> </tr> <tr> <td>$\Phi > 0.4$</td> <td colspan="3">0</td> </tr> </tbody> </table>			Zone Size (mm)	Acceptable Qty			A	B	C	$\Phi \leq 0.15$	Ignore			$0.15 < \Phi \leq 0.25$	3(distance ≥ 10 mm)			$0.25 < \Phi \leq 0.4$	2(distance ≥ 10 mm)			$\Phi > 0.4$	0			Zone Size (mm)	Acceptable Qty			A	B	C	$\Phi \leq 0.15$	Ignore			$0.15 < \Phi \leq 0.25$	3(distance ≥ 10 mm)			$0.25 < \Phi \leq 0.4$	2(distance ≥ 10 mm)			$\Phi > 0.4$	0			Zone Size (mm)	Acceptable Qty			A	B	C	$\Phi \leq 0.2$	Ignore			$0.2 < \Phi \leq 0.5$	2(distance ≥ 10 mm)			$\Phi > 0.5$	0			Zone Size (mm)	Acceptable Qty			A	B	C	$\Phi \leq 0.2$	Ignore			$0.2 < \Phi \leq 0.4$	2(distance ≥ 10 mm)			$\Phi > 0.4$	0		
	Zone Size (mm)					Acceptable Qty																																																																																		
					A	B	C																																																																																	
	$\Phi \leq 0.15$				Ignore																																																																																			
	$0.15 < \Phi \leq 0.25$				3(distance ≥ 10 mm)																																																																																			
$0.25 < \Phi \leq 0.4$	2(distance ≥ 10 mm)																																																																																							
$\Phi > 0.4$	0																																																																																							
Zone Size (mm)	Acceptable Qty																																																																																							
	A	B	C																																																																																					
$\Phi \leq 0.15$	Ignore																																																																																							
$0.15 < \Phi \leq 0.25$	3(distance ≥ 10 mm)																																																																																							
$0.25 < \Phi \leq 0.4$	2(distance ≥ 10 mm)																																																																																							
$\Phi > 0.4$	0																																																																																							
Zone Size (mm)	Acceptable Qty																																																																																							
	A	B	C																																																																																					
$\Phi \leq 0.2$	Ignore																																																																																							
$0.2 < \Phi \leq 0.5$	2(distance ≥ 10 mm)																																																																																							
$\Phi > 0.5$	0																																																																																							
Zone Size (mm)	Acceptable Qty																																																																																							
	A	B	C																																																																																					
$\Phi \leq 0.2$	Ignore																																																																																							
$0.2 < \Phi \leq 0.4$	2(distance ≥ 10 mm)																																																																																							
$\Phi > 0.4$	0																																																																																							
																																																																																								
$\Phi = (X+Y)/2$																																																																																								

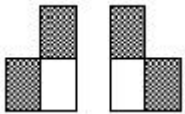

3.0	LCD Pixel defect	<p>Pixel bad points</p> <table border="1"> <thead> <tr> <th data-bbox="539 309 730 360">Item</th> <th data-bbox="730 309 1246 360">Zone A</th> <th data-bbox="1246 309 1497 360">Acceptable Qt</th> </tr> </thead> <tbody> <tr> <td data-bbox="539 360 730 521" rowspan="3">Bright dot</td> <td data-bbox="730 360 1246 416">Random</td> <td data-bbox="1246 360 1497 416">N≤2</td> </tr> <tr> <td data-bbox="730 416 1246 468">2 dots adjacent</td> <td data-bbox="1246 416 1497 468">N≤0</td> </tr> <tr> <td data-bbox="730 468 1246 521">3 dots adjacent</td> <td data-bbox="1246 468 1497 521">N≤0</td> </tr> <tr> <td data-bbox="539 521 730 689" rowspan="3">Dark dot</td> <td data-bbox="730 521 1246 577">Random</td> <td data-bbox="1246 521 1497 577">N≤3</td> </tr> <tr> <td data-bbox="730 577 1246 633">2 dots adjacent</td> <td data-bbox="1246 577 1497 633">N≤0</td> </tr> <tr> <td data-bbox="730 633 1246 689">3 dots adjacent</td> <td data-bbox="1246 633 1497 689">N≤0</td> </tr> <tr> <td data-bbox="539 689 730 1003">Distance</td> <td data-bbox="730 689 1246 1003"> 1. Minimum Distance Between Bright dots. 2. Minimum Distance Between dark dots 3. Minimum Distance Between dark and bright dot. </td> <td data-bbox="1246 689 1497 1003">5mm</td> </tr> <tr> <td colspan="2" data-bbox="539 1003 1246 1059">Total bright and dark dot</td> <td data-bbox="1246 1003 1497 1059">N≤4</td> </tr> </tbody> </table> <p>Note:</p> <p>A) Bright dot: Dots appear bright and unchanged in size in which LCD panel is displaying under black pattern.</p> <p>B) Dark dot: Dots appear dark and unchanged in size in which LCD panel is displaying under pure red, green, blue picture.</p> <p>C) 2 dot adjacent = 1 pair = 2 dots</p> <p>Picture:</p> <div style="display: flex; justify-content: space-around; align-items: flex-start;"> <div style="text-align: center;">  <p>2 dot adjacent</p> </div> <div style="text-align: center;">  <p>2 dot adjacent</p> </div> <div style="text-align: center;">  <p>2 dot adjacent (vertical)</p> </div> <div style="text-align: center;">  <p>2 dot adjacent (slant)</p> </div> </div>	Item	Zone A	Acceptable Qt	Bright dot	Random	N≤2	2 dots adjacent	N≤0	3 dots adjacent	N≤0	Dark dot	Random	N≤3	2 dots adjacent	N≤0	3 dots adjacent	N≤0	Distance	1. Minimum Distance Between Bright dots. 2. Minimum Distance Between dark dots 3. Minimum Distance Between dark and bright dot.	5mm	Total bright and dark dot		N≤4
Item	Zone A	Acceptable Qt																							
Bright dot	Random	N≤2																							
	2 dots adjacent	N≤0																							
	3 dots adjacent	N≤0																							
Dark dot	Random	N≤3																							
	2 dots adjacent	N≤0																							
	3 dots adjacent	N≤0																							
Distance	1. Minimum Distance Between Bright dots. 2. Minimum Distance Between dark dots 3. Minimum Distance Between dark and bright dot.	5mm																							
Total bright and dark dot		N≤4																							



4.0	Line defect (LCD /Polarizer backlight black/white line, scratch, stain)  W: width, L : length N : Count	<table border="1"> <thead> <tr> <th rowspan="2">Width(mm)</th> <th rowspan="2">Length(m)</th> <th colspan="3">Acceptable Qty</th> </tr> <tr> <th>A</th> <th>B</th> <th>C</th> </tr> </thead> <tbody> <tr> <td>$\Phi \leq 0.05$</td> <td>Ignore</td> <td colspan="2">Ignore</td> <td rowspan="3">Ignore</td> </tr> <tr> <td>$0.05 < W \leq 0.06$</td> <td>$L \leq 5.0$</td> <td colspan="2">$N \leq 3$</td> </tr> <tr> <td>$0.06 < W \leq 0.08$</td> <td>$L \leq 4.0$</td> <td colspan="2">$N \leq 2$</td> </tr> <tr> <td>$W > 0.08$</td> <td colspan="4">Define as spot defect</td> </tr> </tbody> </table>	Width(mm)	Length(m)	Acceptable Qty			A	B	C	$\Phi \leq 0.05$	Ignore	Ignore		Ignore	$0.05 < W \leq 0.06$	$L \leq 5.0$	$N \leq 3$		$0.06 < W \leq 0.08$	$L \leq 4.0$	$N \leq 2$		$W > 0.08$	Define as spot defect			
		Width(mm)			Length(m)	Acceptable Qty																						
			A	B		C																						
		$\Phi \leq 0.05$	Ignore	Ignore		Ignore																						
		$0.05 < W \leq 0.06$	$L \leq 5.0$	$N \leq 3$																								
$0.06 < W \leq 0.08$	$L \leq 4.0$	$N \leq 2$																										
$W > 0.08$	Define as spot defect																											
5.0	Electronic Components SMT.	Not allow missing parts, solderless connection, cold solder joint, mismatch, The positive and negative polarity opposite																										
6.0	Display color & Brightness.	1. Color: Measuring the color coordinates, The measurement standard according to the datasheet or samples. 2. Brightness: Measuring the brightness of White screen, The measurement standard according to the datasheet or Samples.																										
7.0	LCD Mura/Waving/ Hot spot	Not visible through 5% ND filter in 50% gray or judge by limit sample if necessary.																										

DESIGN • MANUFACTURE • SUPPLY

8.0	CTP Related	CTP Cover sensor accidented black/white spot	<table border="1"> <thead> <tr> <th rowspan="2">Size Φ(mm)</th> <th colspan="3">Acceptable Qty</th> </tr> <tr> <th>A</th> <th>B</th> <th>C</th> </tr> </thead> <tbody> <tr> <td>$\Phi \leq 0.15$</td> <td colspan="2">Ignore</td> <td rowspan="3">Ignore</td> </tr> <tr> <td>$0.15 < \Phi \leq 0.25$</td> <td colspan="2">4 (distance ≥ 10mm)</td> </tr> <tr> <td>$0.25 < \Phi \leq 0.35$</td> <td colspan="2">3 (distance ≥ 10mm)</td> </tr> <tr> <td>$\Phi > 0.35$</td> <td colspan="3">0</td> </tr> </tbody> </table>	Size Φ (mm)	Acceptable Qty			A	B	C	$\Phi \leq 0.15$	Ignore		Ignore	$0.15 < \Phi \leq 0.25$	4 (distance ≥ 10 mm)		$0.25 < \Phi \leq 0.35$	3 (distance ≥ 10 mm)		$\Phi > 0.35$	0		
			Size Φ (mm)		Acceptable Qty																			
				A	B	C																		
			$\Phi \leq 0.15$	Ignore		Ignore																		
			$0.15 < \Phi \leq 0.25$	4 (distance ≥ 10 mm)																				
$0.25 < \Phi \leq 0.35$	3 (distance ≥ 10 mm)																							
$\Phi > 0.35$	0																							

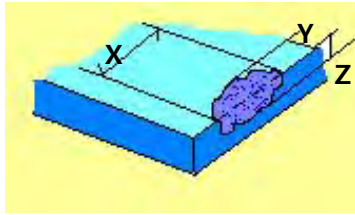

		CTP Cover	<table border="1"> <thead> <tr> <th rowspan="2">Width(mm)</th> <th rowspan="2">Ignore (mm)</th> <th colspan="3">Acceptable Qty</th> </tr> <tr> <th>A</th> <th>B</th> <th>C</th> </tr> </thead> <tbody> <tr> <td>$\Phi \leq 0.05$</td> <td>Ignore</td> <td colspan="3">Ignore</td> </tr> <tr> <td>$0.05 < W \leq 0.06$</td> <td>$L \leq 4.0$</td> <td colspan="3">$N \leq 3$</td> </tr> <tr> <td>$0.06 < W \leq 0.08$</td> <td>$L \leq 3.0$</td> <td colspan="3">$N \leq 2$</td> </tr> <tr> <td>$0.08 < W$</td> <td colspan="4">Define as spot defect</td> </tr> </tbody> </table>	Width(mm)	Ignore (mm)	Acceptable Qty			A	B	C	$\Phi \leq 0.05$	Ignore	Ignore			$0.05 < W \leq 0.06$	$L \leq 4.0$	$N \leq 3$			$0.06 < W \leq 0.08$	$L \leq 3.0$	$N \leq 2$			$0.08 < W$	Define as spot defect			
Width(mm)	Ignore (mm)	Acceptable Qty																													
		A	B	C																											
$\Phi \leq 0.05$	Ignore	Ignore																													
$0.05 < W \leq 0.06$	$L \leq 4.0$	$N \leq 3$																													
$0.06 < W \leq 0.08$	$L \leq 3.0$	$N \leq 2$																													
$0.08 < W$	Define as spot defect																														
		CTP Cover Pinhole/ Lack of ink	<table border="1"> <thead> <tr> <th>Zone Size (mm)</th> <th>Acceptable Qty</th> </tr> </thead> <tbody> <tr> <td>$\Phi \leq 0.2$</td> <td>Ignore</td> </tr> <tr> <td>$0.2 < \Phi \leq 0.3$</td> <td>4(distance ≥ 10mm)</td> </tr> <tr> <td>$0.3 < \Phi \leq 0.4$</td> <td>2(distance ≥ 10mm)</td> </tr> <tr> <td>$\Phi > 0.4$</td> <td>0</td> </tr> </tbody> </table>	Zone Size (mm)	Acceptable Qty	$\Phi \leq 0.2$	Ignore	$0.2 < \Phi \leq 0.3$	4(distance ≥ 10 mm)	$0.3 < \Phi \leq 0.4$	2(distance ≥ 10 mm)	$\Phi > 0.4$	0																		
Zone Size (mm)	Acceptable Qty																														
$\Phi \leq 0.2$	Ignore																														
$0.2 < \Phi \leq 0.3$	4(distance ≥ 10 mm)																														
$0.3 < \Phi \leq 0.4$	2(distance ≥ 10 mm)																														
$\Phi > 0.4$	0																														
		CTP Bonding bubble/ accidented spot	<table border="1"> <thead> <tr> <th rowspan="2">Size Φ(mm)</th> <th colspan="2">Acceptable Qty</th> </tr> <tr> <th>A</th> <th>B</th> </tr> </thead> <tbody> <tr> <td>$\Phi \leq 0.1$</td> <td colspan="2">Ignore</td> </tr> <tr> <td>$0.1 < \Phi \leq 0.2$</td> <td colspan="2">3(distance ≥ 10mm)</td> </tr> <tr> <td>$0.2 < \Phi \leq 0.3$</td> <td colspan="2">2(distance ≥ 10mm)</td> </tr> <tr> <td>$\Phi > 0.3$</td> <td colspan="2">0</td> </tr> </tbody> </table>	Size Φ (mm)	Acceptable Qty		A	B	$\Phi \leq 0.1$	Ignore		$0.1 < \Phi \leq 0.2$	3(distance ≥ 10 mm)		$0.2 < \Phi \leq 0.3$	2(distance ≥ 10 mm)		$\Phi > 0.3$	0												
Size Φ (mm)	Acceptable Qty																														
	A	B																													
$\Phi \leq 0.1$	Ignore																														
$0.1 < \Phi \leq 0.2$	3(distance ≥ 10 mm)																														
$0.2 < \Phi \leq 0.3$	2(distance ≥ 10 mm)																														
$\Phi > 0.3$	0																														
		Assembly deflection	beyond the edge of backlight ≤ 0.2 mm																												
		CTP cover broken	<table border="1"> <thead> <tr> <th>X</th> <th>Y</th> <th>Z</th> </tr> </thead> <tbody> <tr> <td>$X \leq 0.5$mm</td> <td>$Y \leq 0.5$mm</td> <td>$Z < \text{cover thickness}$</td> </tr> </tbody> </table> <p>* Circuitry broken is not allowed.</p>	X	Y	Z	$X \leq 0.5$ mm	$Y \leq 0.5$ mm	$Z < \text{cover thickness}$																						
X	Y	Z																													
$X \leq 0.5$ mm	$Y \leq 0.5$ mm	$Z < \text{cover thickness}$																													

		CTP cover broken	X	Y	Z	
			X ≤ 0.3mm	Y ≤ 0.3mm	Z < cover thickness	
		X : length	* Circuitry broken is not allowed.			
		Y : width				
		Z : height				

Criteria (functional items)

Number	Items	Criteria (mm)
1	No display	Not allowed
2	Missing segment	Not allowed
3	Short	Not allowed
4	Backlight no lighting	Not allowed
5	CTP no function	Not allowed

MIDAS
DISPLAYS

DESIGN • MANUFACTURE • SUPPLY



8. Reliability Test Result

Item	Condition	Inspection after test
High Temperature Operating	70°C,96HR	Inspection after 2~4hours storage at room temperature, the sample shall be free from defects: 1.Air bubble in the LCD; 2.Non-display; 3.Missing segments/line; 4.Glass crack; 5.Current IDD is twice higher than initial value.
Low Temperature Operating	-20°C, 96HR	
High Temperature Storage	80°C, 96HR	
Low Temperature Storage	-30°C, 96HR	
High Temperature & High Humidity Operating	+60°C, 90% RH ,96 hours.	
Thermal Shock (Non-operation)	-30°C,30 min ↔ 80°C,30 min, Change time:5min 20CYC.	
ESD test	C=150pF, R=330,5points/panel Air:±8KV, 5times; Contact:±6KV, 5 times; (Environment: 15°C~35°C, 30%~60%).	
Vibration (Non-operation)	Frequency range:10~55Hz, Stroke:1.5mm Sweep:10Hz~55Hz~10Hz 2 hours for each direction of X.Y.Z. (6 hours for total) (Package condition).	
Box Drop Test	1 Corner 3 Edges 6 faces,80cm(MEDIUM BOX)	

Remark:

- 1.The test samples should be applied to only one test item.
- 2.Sample size for each test item is 3~10pcs.
- 3.For Damp Proof Test, Pure water(Resistance > 10MΩ) should be used.
- 4.In case of malfunction defect caused by ESD damage, if it would be recovered to normal state after resetting, it would be judged as a good part.
- 5.Failure Judgment Criterion: Basic Specification, Electrical Characteristic, Mechanical Characteristic, Optical Characteristic.



9. Cautions and Handling Precautions

9.1 Handling and Operating the Module

(1) When the module is assembled, it should be attached to the system firmly.

Do not warp or twist the module during assembly work.

(2) Protect the module from physical shock or any force. In addition to damage, this may cause improper operation or damage to the module and back-light unit.

(3) Note that polarizer is very fragile and could be easily damaged. Do not press or scratch the surface.

(4) Do not allow drops of water or chemicals to remain on the display surface.

If you have the droplets for a long time, staining and discoloration may occur.

(5) If the surface of the polarizer is dirty, clean it using some absorbent cotton or soft cloth.

(6) The desirable cleaners are water, IPA (Isopropyl Alcohol) or Hexane.

Do not use ketene type materials (ex. Acetone), Ethyl alcohol, Toluene, Ethyl acid or Methyl chloride. It might permanent damage to the polarizer due to chemical reaction.

(7) If the liquid crystal material leaks from the panel, it should be kept away from the eyes or mouth. In case of contact with hands, legs, or clothes, it must be washed away thoroughly with soap.

(8) Protect the module from static; it may cause damage to the CMOS ICs.

(9) Use finger-stalls with soft gloves in order to keep display clean during the incoming inspection and assembly process.

(10) Do not disassemble the module.

(11) Protection film for polarizer on the module shall be slowly peeled off just before use so that the electrostatic charge can be minimized.

(12) Pins of I/F connector shall not be touched directly with bare hands.

(13) Do not connect, disconnect the module in the "Power ON" condition.

9.2 Storage and Transportation.

(1) Do not leave the panel in high temperature, and high humidity for a long time.

It is highly recommended to store the module with temperature from 0 to 35 °C and relative humidity of less than 70%

(2) Do not store the TFT-LCD module in direct sunlight.

(3) The module shall be stored in a dark place. When storing the modules for a long time, be sure to adopt effective measures for protecting the modules from strong ultraviolet radiation, sunlight, or fluorescent light.

(4) It is recommended that the modules should be stored under a condition where no condensation is allowed. Formation of dewdrops may cause an abnormal operation or a failure of the module.

In particular, the greatest possible care should be taken to prevent any module from being operated where condensation has occurred inside.

(5) This panel has its circuitry FPC on the bottom side and should be handled carefully in order not to be stressed.

